



TABLE OF CONTENTS

Dresser Piping Specialties	1-12
Pipe Connection & Repair Products	13-18
Gas Meter Specialties	19-22
Gaskets & Packing	23-24
Continental Risers & Fittings	25-30
Yellow Polypipe	31-33
Gas Accessories	34-38
Gauges & Thermometers	39-45
Heating Accessories	45-50
Conbraco Products	51-52
Hydronic Specialties	53-55
Gas/Oil Burner Specialties	56-60
Circulator Products	61
Water Heater Accessories	62-63
Electrical Accessories	64-66
Fire Sprinklers	67-68
Pipe Hangers	69-76
Sammy Screws	77-78
Fasteners	79-80
Stud Guards	82
Brass Compression/Flare Fittings	83-86
Chrome Fittings	87-88
Sink Specialties	91-108
3M® Water Filters	109-111
Hoses & Hose Specialties	112-126
Strainers & Drains	128-136
Tubular Brass/PVC	137-146
Test & Cleanout Plugs	147-151
Shower Pan Liner	152-153
Tub & Shower Specialties	154-167
Toilet Specialties	168-189
Sloan Flushometers/Parts	190-199
Sloan Flushmate Products	200-201
Delany Flushometers/Parts	202-204
Faucet Repair Parts	205-221
Delta OEM Parts	222-223
Gerber OEM Parts	224-225
American Standard OEM Parts	226
Tools, Chemicals, & MRO Specialties	227-271

WHO'S WHO AT WAL-RICH



Andrew Rich, Marketing



Daniel Rich, Purchasing



Randy Rich, Sales



Rose Baichoo, Sales



Alex Serlen, Sales



Austin Laplante, Sales



Wayne Krantz, Sales Manager



Ginger McDonough, Controller



Virginia Hermidas, A/R



Claire Barrett, A/A



Packaging & Assembly Dept.



Shipping & Receiving Department



A

Abrasive Pads 235
 Access Panels 126
 Actuators, Am Std 173
 ADA Trap Covers 139
 Adapter Elbow, DW 125
 Adapter Elbow, Ice Mkr . 125
 Adapter Elbows, Cast ... 53
 Adapter Tees, Cast 53-54
 Adapters, Aerator 104-106
 Adapters, Cast Brass ... 53
 Adapters, CPVC 86
 Adapters, Fire Hydrant .. 118
 Adapters, Gas Range ... 122
 Adapters, Hose 116
 Adapters, Max-A-Valve .. 94
 Adapters, Sweat x IPS.. 86
 Adapters, Trap 142
 Add-A-Showers 156
 Aerator Adapters 104-106
 Aerators 104-106
 Afterthought Showers 156
 Air Admittance Valves .. 103
 Air Cocks 52
 Air Vents, Radiator 47
 Aluminum Tubing 56
Am Std Genuine Parts . 226
 Anchor Kits 80
 Anchors 76
 Anodes 35
 Aquastat Wells 45
 Augers 244
 Axes 260

B

Backflow Preventer 115
 Backwater Valves 121, 146
 Bags, trash 259
 Ballcock Repair 176
 Ballcock, Fillpro 175
 Ballcock, **Fluidmaster** . 176
 Ballcock, to fit Rialto 175
 Ballcocks 175
 Ballcocks, **Korky** 168
 Balls, Inflatable Test 151
 Band Iron 74
 Barnes & Jones 50
 Bars, Shower 160
 Baseboard Tees 53
Basin Buddy Wrench ... 251
 Basin Cocks 100
 Bath Shoes 163

Bathcocks 155
 Batteries 255
 Bead Chain 164
 Bending springs 232
 Bibb Screws 221
Bibblocks 118
 Bibbs 100
 Bigfoot Toilet Plate 187
 Bits, **Irwin** Speedbor ... 231
 Bits, Masonary 80
 Bits, Paddle 231
 Blacktop Patch 271
 Blades, Grinder 231
 Blocks, Laundry Tray 107
 Boca Plates 82
 Boca Vent 103
 Boiler Tube Plugs 49
 Bolts, Close-Couple 181
 Bolts, Closet Flange 185
 Bolts, Flange 185
 Bolts, Hex 24
 Bolts, Johnny-Style 185
 Bolts, Nylon Toilet Seat 188
 Bolts, Tank-to-Bowl 181
 Boxes, Ice Maker 126
 Boxes, WM Valve 126
 Brackets, Pipe support . 76
 Brackets, Riser 35
 Brackets, Support 76
 Breaker, Hose Vacuum . 115
 Brushes, Chip 235
 Brushes, Copper Tube .. 234
 Brushes, Flux 235
 Brushes, Pipe Dope 235
 Bubbler Heads 101
 Buckets, Organizer 243
 Bulbs 255
 Bungee Cords 253
 Bushings, Duplex Tank . 60

C

Cable Ties 66
 Caps, Blank 142
 Caps, Closet Carrier 185
 Caps, Dirt Pocket 49
 Caps, Hose 116
 Caps, Mushroom 150
 Caps, Rubber Test 148
 Caps, Tapped 48
 Carbon Monoxide Alarm 257
 Cartridge Pullers 247
 Cast Iron Cleanouts 146
 Caulk Guns 253
 Caulk Removal Tool 254

Caulk, Tub & Tile 266
 Caulking Irons 236
 Caution Tape 248
 Ceiling Support Rods 161
 Cesspool Plates 136
Channellock Wrenches 229
 Chrome Fittings 87-88
 Chrome Nipples 87
 Circulator Couplings 61
 Circulator Flanges 61
 Circulator Gaskets 24
 Circulator Gaskets 61
 Circulator Oil 269
Clam Flange 187
 Clamps, "C" 69
 Clamps, cushion 75
 Clamps, Grounding 63
 Clamps, Jr. Beam 69
 Clamps, Pipe 13
 Clamps, Riser 71
 Clamps, Skinner 18
 Clamps, SS Hose 115
 Clamps, Strut 75
 Clamps, Tubing 72-74
 Cleanout Plugs 147-148
 Cleanouts, Cast Iron 146
 Clevis Hangers 71
 Clips, Pipe 73
 Closet Carrier Caps 185
 Closet Flange Extender 188
 Closet Flanges 182-184
 Closet Spuds 189
 Cloth, Emery 235
 Cloth, Grit 235
 CO Detectors 257
 Cocks, Air 52
 Coin Vents 47
 Cold Solder 261
 Compound 270
 Compression Fittings 83-86
Conbraco Products 51-52
 Conduit, Flexible NM 66
Consolidated Valves 12
Continental Products .. 25-31
 Contractor trash bags ... 259
 Copper Tube Brushes ... 234
 Cotton wicking 237
 Couplings, Bathcock 155
 Couplings, Circulator 61
 Couplings, Dresser 1-12
 Couplings, Hymax 18
 Couplings, No Hub 17
 Couplings, Pipe 14
 Couplings, Rod 79
 Couplings, Rubber 16
 Couplings, Water Meter 15

Coveralls 241
 Covers, ADA Trap 139
 Covers, Cleanout 149
 Covers, Cock Hole 99
 Covers, Floor Drain 136
 Covers, Tank 188
 Crayons 269
 Crown-Rinse Products .. 107
 Cushion clamps 75
 Cutters, Copper Tube 232
 Cutters, Glass Tubing ... 49
 Cutters, Inside PVC 233
 Cutters, PEX 232
 Cutters, PVC 232

D

Dandy Cleanout Tees 146
Delany Flushometers ... 203
Delany Genuine Parts .. 202-204
Delta Genuine Parts 222-223
 Dental Picks 245
 Desanco Fittings 142
 Diaphragm Gauges 41
 Dielectric Unions 63
 Dip Tubes 62
 Discs, Snap/Screw 173
 Dishwasher Tailpieces ... 140
 Disposal Parts 103
 Diswasher Connection .. 113
 Diverter Elbow 155
 Donuts, Rubber 16
 Douglas Valves 172
 Drain Augers 244
 Drain Cleaning Tools 243-245
Drain King Products 243
 Drains, Flip-It 166
 Drains, Tip Toe 166
 Drains, Tub 164-166
Dresser Products 1-12
 Drop Ear Elbows 159
 Drop Ear Elbows 53
 Drop Lights 255
 Dropcloths 238
 Dryer Vent Kits 123-124
 Drywall Compound 270
 Dust Masks 241

E

Ear Protection 242
 Earplugs 242
EasyFit Isolation Valve.. 18
 Econo Caps 148

Econo Plugs 148
 Elbows, Cast Adapter ... 53
 Elbows, Drop Ear 159
 Elbows, Drop Ear 53
 Elbows, Oil Tank 59
 Elbows, Tubular 141
 Electrical Accessories .. 64-66
 Electrical Boxes 64
 Escutcheons 96-97
 Escutcheons, Shower ... 159
 Escutcheons, Sprinkler . 68
 Expanding Foam 264
 Expansion Shields 76
 Extension Cords 255
 Eye Protection 241
 EZ Plug 159
 EZ Traps 145
 EZ-Bite Fittings 89-90

E

F & C Plates, Plastic 97
 F & C Plates, Steel 98
 Fast Orange Soaps 269
 Faucet Repair Parts 205-219
 Faucet Washers 227-228
 Faucets 100-101
 Faucets, Bubbler 101
 Faucets, Cup Filler 101
 Faucets, Water Cooler .. 101
 Faucets, Water Filter 101
 Fiberglass Shwr Elbow .. 159
 Fill Boxes 60
 Filters, 3M Aquapure 109-111
 Filters, Oil 59
 Fire Hydrant Adapters ... 118
 Fire Sprinkler Guards 68
 Fire Sprinkler Heads 67
 First Aid Kits 242
 Fitt'n Saver Reamer 233
 Fittings, Compression ... 83-86
 Fittings, CP Brass 87-88
 Fittings, Desanco 142
 Fittings, Flare 85-86
 Fittings, Gas Appliance . 38
 Fittings, PE Gas 25-31
 Fittings, Push-on 89-90
 Fittings, Quick-Connect 38
 Fittings, Trap 142
 Fittings, Water Service .. 14-15
 Flame Shields 237
 Flange Isolation Kits 22
 Flange Repair 186-187
 Flanges, 150# 22
 Flanges, Circulator 61

Flanges, Closet 182-184
 Flanges, Jumbo 161
 Flanges, Malleable 60
 Flanges, Shower Rod 161
 Flanges, Toilet 182-184
 Flanges, Urinal 189
 Flanges, Water Meter ... 15
 Flappers 168-172
 Flappers, **Korky** 168
 Flare Fittings 85-86
 Flaring Tools 234
 Flexible Oil Lines 59
 Flexidrains 145
 Float Balls 175
 Floats, Grout 254
 Floodstoppers 136
 Floor Drain Covers 136
 Flow Restrictors 158
Fluidmaster Products.. 176-7
Flushmate Parts 200-201
Flushmate Tanks 200
 Flushvalve, Urinal 189
 Flushvalves, Douglas 172
 Flushvalves, Fit Am Std . 173
 Flushvalves, Mansfield .. 174
 Flux, **Nokorode** 264
 Flux, **Utility** 264
 Foam, Expanding 264
Frajon AAV 103
 Fresh Air Plate 150
 Funnels 259
 Fusible Plug Valves 59

G

Garbage disposal cords 255
 Garden Hoses 119
 Gas Ball Valves 122
 Gas Cocks, Lockwing ... 21
 Gas Compression Ftgs . 36
 Gas Fittings 25-31
 Gas Labels 35
 Gas Meter Products 19-20
 Gas Proving Pump 151
 Gas Range Connectors . 122
 Gas Risers 25, 36
 Gas Test Kits 41-42
 Gas Vent Signs 58
 Gasket Strainers 22
 Gaskets, Circulator 24
 Gaskets, Circulator 61
 Gaskets, Close Couple . 181
 Gaskets, Closet Flange 186
 Gaskets, Companion 23
 Gaskets, Full Face 23

Gaskets, Ring 23
 Gaskets, Tank-to-Bowl .. 181
 Gaskets, Urinal Flange . 189
 Gaskets, Wax 186
 Gauge Glass 48
 Gauges 39-45
 Gauges, Fire Sprinkler .. 68
 Gauges, UL-FM 68
 GE Silicone Caulk 266
Gel-Gloss Cleaners 265
Gerber Genuine Parts .. 224-225
 Glass, Boiler Sight 48
 Gloves 239-240
 Glueboards 269
 Gorilla Glue 261
Gorilla Grip Gloves 240
 Gorilla Tape 261
 Grab Bars 165
 Graphite Packing 262
 Greez-Off Degreaser 265
 Grid Drains 131
 Grids, Bath Shoe 163
 Grids, Shower 134, 136
 Grinder Blades 231
 Ground Jt. Connection .. 142
 Grounding Clamp Kits ... 63
 Grout Floats 254
 Guards, Fire Sprinkler ... 68

H

Hair Snare 164
 Hammers 260
 Hand Cleaner 269
 Hand Warmers 242
 Handheld Shower 155
 Handle Pullers 247
 Handles, Faucet 205-219
 Handles, Radiator 46
 Handles, Valve 118
 Handy Hands 245
 Hangers, Conduit 65
 Hangers, Malleable 69-70
 Hangers, Pipe 69-76
 Hangers, Sink 102
 Hardhats 242
 Hatchets 260
 Heads, Pullout Faucet .. 108
 Hex Keys 81
Honeywell Pilots 56
 Hose Bibb Anchor Kit 117
 Hose Bibb Mounting Plt 117
 Hose Caps 116
 Hose Nipples 116
 Hose Nozzles 119

Hose Reels 120
 Hose Vacuum Breaker .. 115
 Hose, Dryer Vent 123-124
 Hoses, Discharge 113
 Hoses, Garden 119
 Hoses, Generator 38
 Hoses, Outdoor Gas 38
 Hoses, Pullout Spray 108
 Hoses, WM Inlet 112
 Hydraulic Cement 271
 Hymax Couplings 18

I

Ice Maker Kits 125
Innerlynx 37
 Inverted Marking Paint ... 271
Irwin Speedbor Bits 231
 Isolation Valves 55

J

J-B Kwikweld Epoxy 266
 Joint Runners 236

K

Knives, Utility 230
Korky Flappers 168

L

Labels 35, 58
 Lampwick 237
 Last Drop Suction Gun .. 257
 Laundry Tray Blocks 107
 Lavatory Legs 102
 Lead Ingots 236
 Lead Wool 236
 Leak Shreak 257
Leak-Lock Sealants 264
 Levels 252
 Lift Wires 172
 Light Bulbs 255
 Liners, 55 gallon drum ... 259
 Link seals 37
 Lint Snares 113
 Lint Trap Kits 124
Liquid Wrench 265
 Locknuts, Spud 189
 LP-EZ Products 54-55
 Lubricated Plug Valves .. 21

Lumber Crayons 269

M

Mallets 260
 Marking Balls 35
 Marking Paint 271
 Marking Stakes 35
 Marvel Fittings, Brass ... 142
 Mason Twine 253
 Match Extenders 256
 Max-A-Valve Adapters ... 94
 Mepco 50
Metacaulk Firestop 265
 Meter Bars 19
 Meter Valves 21
 Mini-ball Valves 41
 Mini-Snake 245
 Mirrors 256
 Monoflow Tees 54
 Mortar 270
 Mousetraps 269
MSP Wrap Tape 262

N

Nail Plates 82
 Needle Valves 125
 Needle Valves 45
 Nemesis Glasses 241
 Nipple Trays 243
 Nipples, CP Brass 87
 Nipples, Dielectric 63
 Nipples, Hose 116
 No Hub Couplings 17
Nokorode Flux 264
 Non-Asbestos Sheets ... 24
Nordstrom Valves 21
 Nuts, Ballcock 92
 Nuts, Basin 92
 Nuts, Closet Carrier 185
 Nuts, Pilot 57
 Nuts, Rod 79
 Nuts, Slip 142
 Nylon Cam Straps 253

O

O'Keefe's Moisturizer 261
 Oakum 236
 Oil Dri Granules 259
 Oil Filters 59

Oil Tank Specialties 59-60
 O-ring Puller 245
 O-rings 220

P

P/T Plugs 45
 Packing, Non-Asbestos 24
 Packing, Rubber 24
 Packing, Stem 262
 Pails 243
 Pan Liner Cement 152
 Pan Liner 152
 Perforated Hanger Iron .. 74
Permatex Products 263
 Personal Shower 155
 Philadelphia Vent Box ... 150
 Pigtails 45
 Pilot Nuts 57
 Pilot Tubing Kits 56
 Pipe Clamps 12
 Pipe Clips 73
 Pipe Hangers 69-76
 Pipe Straps 72
 Pipe Taps 229
 Pipe Wrap Tape 37
 Pipe, Yellow PE Gas 32
 Pittsburgh Bell Trap 150
 Plaster of Paris 270
 Plates, "Goof" 166
 Plates, Boca 82
 Plates, Cesspool 136
 Plates, Fresh Air 150
 Plates, Pipe Repair 13
 Plates, S.S. Extension . 149
 Plates, Shower Trim 166-7
 Plug, EZ 159
 Plug, Sewer Relief 149
 Plugs, Boiler Tube 49
 Plugs, C.I. Wingnut 151
 Plugs, Cleanout 147-148
 Plugs, Inflatable Test 151
 Plugs, Lead Fitall 148
 Plugs, P/T 45
 Plugs, Rubber Test 148
 Plugs, Trap 151
 Plumber's Candles 237
Plumberex 139
 Plungers 244-245
Polyken Tape 37
 Poppy Sewer Plug 149
 Pop-up Stoppers 133
 Pop-Up Wastes 131
Porc-a-fix 268

Porcelain Glaze 268
 Por-Rok Cement 271
 Pre-Rinse Parts 127
 Pressure gauges 39-45
 Probing Rods 258
 Provents 103
 Pry Bar 260
 Pullout Sprays 108
 Pumps, Bike 151
 Pumps, Gas Proving 151
 Push-on Fittings 89-90
 Putty Knives 253
 Putty 266
 PVC Tubular Products .. 143-145

Q

Quarter-Turn Sillcocks .. 54-55
 Quarter-Turn Valves 54-55
 Quick-Connects 38
 Quikrete 270

R

Rags 256
 Rasps 260
RCS Acutators 12
 Reamed Adapters 53, 86
 Reamers, PVC Socket .. 233
 Reamers, Seat 250
Rectorseal No. 5 264
RetroValves 95
 Risers, Anodeless 25
 Risers, Compression 36
 Risers, **Con-Stab** 25
 Risers, Flexible 30
 Risers, Water Supply 91
 Rod, Ballcock 175
 Rods, Shower 160
 Roof Flashings 82
Roots Blowers 12
Roots Meters 12
 Rosettes 92
 Rosin Paper 238
Royston Mastic 37
 Rubber Sheets 24
 Rubber Tie Downs 253
 Runoff Tubes 62

S

Saddles, Cast Iron 13
 Saddles, PVC 145

Safety Vests 241
Sammy Screws 77-78
 Saws, Jab 231
 Saws, Mini Hacksaw 230
 Saws, PVC Cable 233
 Saws, Quickdraw 233
 Scraper, Glass 231
 Screens, Termination 150
 Screw & Anchor Kits 80
 Screw Extractors 229
 Screwdrivers 81
 Screws, Bibb 221
 Screws, Trip Plate 163
 Screws, Zip 80
 Seat Gauge 221
 Seats, Faucet 205-219, 221
 Self-Tapping Valve 125
 Sewage Ejector Valves.. 121
 Sewer Relief Plug 149
 Sheeting, Plastic 238
 Shims 187
 Shop Towels 256
 Shovels 258
 Shower Arms 159
 Shower Curtain Pins 162
 Shower Door Parts 167
 Shower Heads 157-158
 Shower Pan Liner 152
 Shower Rebuild Kits 217-219
 Shower Rod Flanges 161
 Shower Rods 160
 ShuBees 240
 Siamese Connection 117
 Sight Glass 48
 Signs, Gas Vent 58
 Sillcock Keys 118
 Sillcocks 54, 55, 118
 Sillcocks, Quarter Turn . 54-55
Silver King Products ... 267
 Sink Bibbs 100
 Sink Clips 102
 Sink Collar 140
 Sink Funnels 140
 Sink Hangers 102
 Skinner Clamps 18
 Slip Elbows 141
 Slipnuts 142
Sloan Flushometers 193
Sloan Genuine Parts 190-199
 Smoke Alarms 257
 Snakes 244
 Soap Dispensers 107
 Soil Probes 258
 Solder Ladle 236
 Solder Pot 236
 Spackle 270

Spanner Flange 186
 Spark Lighters 237
 Speedies 91
 Splash Guards 162
 Split Escutcheons 97
 Sponges 254
 Spouts 154-155
 Spray Bottles 256
 Spray Paint 271
 Spray Paint 271
 SpringFlo Aerators 104
Spud Buddy Wrench ... 199
 Spuds 189
 SS Corrugated Hoses ... 63
 SS Hose Clamps 115
 Stack and Seal Flanges 188
 Steam Traps 50
 Steel Wool 235
 Stem Grease 262
 Stem Packing 262
 Stems, Faucet 205-219
 Stiffeners 115
 Stoppers, Pop-up 133
 Stoppers, Rubber 164
 Stops, Compression 93-95
 Stops, Quarter Turn 93-95
 Stove bolts 79
 Strainers, Basket 128-130
 Strainers, Crumb Cup ... 132
 Strainers, Duo 128-130
 Strainers, Ketchall 132
 Strainers, Perforated 133
 Strainers, Shower 134-135
 Strainers, Sink 128-130
 Strainers, SS Mesh 133
 Strainers, Urinal 134
 Straps, Pipe 72
 Strikers 237
 Structolite 270
 Strut Clamps 75
 Stud Guards 82
 Suds Stoppers 133
 Sump Pump Kits 122
 Supply Tubes 91
 Support Brackets 76
 Syphons 45

I

Tailpieces, PVC Flex 145
 Tailpieces, Tubular 139-140
 Tank Balls 169, 172
 Tank Covers 188
 Tank Levers 178-180

Tank-to-Bowl Gaskets ... 181
 Tank-to-Bowl Kits 181
Tapcon Screws 78
 Tape, Caution 259
 Tape, Direct Burial 34
 Tape, Duct 238
 Tape, Electrical 238
 Tape, Foil 238
 Tape, Painters 238
 Tape, Pipe Wrap 37
 Tape, Teflon 268
 Teardrop Hangers 70
 Tees, Cast Adapter 53-54
 Tees, Tubular 141-142
 Teflon Tape 268
 Termination Screens 150
 Termination Screens 57
 Terry Towels 256
 Test Caps, Rubber 17
 Test Plugs, Rubber 17
 Thermocouples 56
 Thermometers 43-44
 Thermostat Guards 66
 Thermostats 62
 Thermowells 45
 Threaded Rod 79
 3M Aquapure Filters 109-111
3M Hand Pads 235
 Tie Wire 74
 Tin Snips 252
 Toggle Plates-Oil/Gas ... 64
 Toilet Flanges 182-184
 Toilet Paper Roller 188
 Tools, Chamfer 27
 Torch Pads 237
 Totes 243
 Towel Bars 167
 Tracer Wire 34
 Trap Primers, Tubular ... 132
 Traps, Condensate 145
 Traps, LA-Pattern 137
 Traps, NY Regulation 137
 Traps, PVC Tubular 143-145
 Traps, Steam 50
 Traps, Tubular Brass 137-8
 Tridicators 44-45
 Trip Plates 162
 Trip Waste Assemblies . 164-165
 Trowels 253, 254
 Tub Spouts 154-155
 Tubes, Water Heater 62
 Tubing Clamps 72-74
 Tubing, Clear Vinyl 114
 Tubing, Polyethylene 114
 Tubular Brass 137-142

Twine, Mason 253

U

Unions, Dielectric 63
 Urinal Flanges 189
 Urinal Flush Valve 189
Utility Flux 264

V

Vacuum Breakers 52
 Valves, 3-way Test 68
 Valves, Air Admittance .. 103
 Valves, Backwater 121, 146
 Valves, Coin-Key 47
 Valves, CSA Gas Ball ... 122
 Valves, Fusible Plug 59
 Valves, Isolation 55
 Valves, Needle 125
 Valves, Needle 45
 Valves, Radiator 45
 Valves, Radiator 46
 Valves, Relief 51-52
 Valves, Self-Closing 158
 Valves, Self-tapping 125
 Valves, Sewage Ejector 121
 Valves, Shower Diverter . 158
 Valves, Tailpiece Check 133
 Vent Caps 60
 Vents, Air 47
 Vents, Peck 19
 Vessel Sink Wastes 131
 Vinyl Tubing 114

W

WAGS Valve 63
 Wands, Pullout 108
 Washers, Ballcock 92
 Washers, Basin 92
 Washers, Bath Shoe 163
 Washers, Faucet 227-228
 Washers, Flushvalve 172
 Washers, Hose 117
 Washers, Mack 132
 Washers, Neo Mold 228
 Washers, Rod 79
 Washers, Slip Joint 228
 Washers, Spud 189
 Washers, W & O 163
 Washing Machine Hose 112
 Wasp & Hornet Spray ... 269

Waste & Overflow 164-165
 Waste Bends 138
 Water Alarms 257
 Water Filters 109-111
 Water Filters 109-111, 126
 Water Gauge Sets 48, 52
 Water Hammer Arrestor 120
 Water Heater Elements 62
 Water Meter Keys 258
 Water Service Fittings ... 14-15
Water Wow Granules .. 257
 Wax Gaskets 186
WD40 265
 Wicking 237
 Wire Nuts 66
 Wire, AC-MC-BX 65
 Wire, ROMEX 65
 Wire, Thermostat 65
 Wire, Tracer 34
 Wrecking Bar 260
 Wrench, 4 way Extractr 230
 Wrench, Basin Buddy ... 251
 Wrench, Basin 251
 Wrench, Box 237
 Wrench, Channellock 229
 Wrench, Element 251
 Wrench, Hex 81
 Wrench, Hex 250
 Wrench, Internal Spud ... 248
 Wrench, Internal 231
 Wrench, Locknut 248
 Wrench, No Hub 252
 Wrench, No Hub 81
 Wrench, PO Plug 248
 Wrench, Radiator Spud . 251
 Wrench, Seat 249
 Wrench, Shower Socket 249
 Wrench, Spanner 248
 Wrench, Spud Buddy 199
 Wrench, Strainer 248-249
 Wrench, Strap 250
 Wrench, Symmons 230
 Wrench, Toilet Seat 250
 Wrench, Tub Drain 248
 Wrench, Yellow Grip 229

XYZ

X-pando 263
 Y-Strainers, ConEd 22
 Zip Screws 80

**DRESSER™
PIPELINE SOLUTIONS**

**For Water
Service**

STYLE 38 COUPLINGS FOR STEEL PIPE

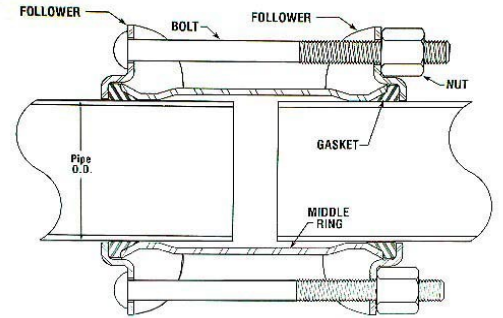

Anatomy of a Style 38 Dresser Coupling

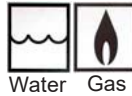

Size	[OD]	Armored	Plain	Low Pressure Steam
1/2" IPS	[.84]	2801002	2801302	2801489
3/4" IPS	[1.05]	2801004	2801304	2801490
1" IPS	[1.32]	2801006	2801306	2801492
1 1/4" IPS	[1.66]	2801008	2801308	2801494
1 1/2" IPS	[1.90]	2801010	2801310	2801496
2" IPS	[2.38]	2801012	2801312	2801498
2 1/2" IPS	[2.88]	2801014	2801314	2801500
3" IPS	[3.50]	2801016	2801316	2801502
3 1/2" IPS	[4.00]	2801018	2801318	2801503
4" IPS	[4.50]	2801020	2801320	2801504
5" IPS	[5.563]	2801022	2801322	2801506
6" IPS	[6.63]	2801024	2801324	2801508
8" IPS	[8.63]	2801026	2801326	2801510
10" IPS	[10.75]	2801028	2801328	2801512
12" IPS	[12.75]	2801030	2801330	2801514

- All **Style 38's** feature a Fusion-Bonded Epoxy Coating to prevent corrosion, except for Steam Couplings (Red Shop Coat)
- All **Style 38's** have corrosion-resistant alloy bolts and nuts (5/8" x 8 1/4")
- **Wal-Rich** stocks all Style 38's with **5"** long **middle rings** (the body of the coupling)
- For special sizes or configurations, call our Dresser Specialists at 800-221-1157

**DRESSER™
PIPELINE SOLUTIONS**

**For Water
Service**

**STYLE 65 GALVANIZED
COMPRESSION FITTINGS
FOR STEEL PIPE**



Armored Gaskets



Water

W-R#	Diameter
2804202	1/2" Short #65 Coupling
2804204	3/4" Short #65 Coupling
2804206	1" Short #65 Coupling
2804208	1 1/4" Short #65 Coupling
2804210	1 1/2" Short #65 Coupling
2804212	2" Short #65 Coupling

W-R#	Diameter
2804002	1/2" Long #65 Coupling
2804004	3/4" Long #65 Coupling
2804006	1" Long #65 Coupling
2804008	1 1/4" Long #65 Coupling
2804010	1 1/2" Long #65 Coupling
2804012	2" Long #65 Coupling

W-R#	Diameter
2804404	3/4" #65 90° Elbow
2804406	1" #65 90° Elbow
2804410	1 1/2" #65 90° Elbow
2804412	2" #65 90° Elbow

W-R#	Diameter
2804301	1/2" #65 Male Adapter
2804302	3/4" #65 Male Adapter
2804304	1" #65 Male Adapter
2804306	1 1/4" #65 Male Adapter
2804308	1 1/2" #65 Male Adapter
2804310	2" #65 Male Adapter

- For Water Service. Rated to 150 PSI,
at temperatures up to 150 degrees

**DRESSER™
PIPELINE SOLUTIONS**

**For Water
Service**

**STYLE 90 COMPRESSION
FITTINGS FOR STEEL PIPE
(SEAL-ONLY)**



W-R#	Description
2806004	3/4" Style 90 Coupling
2806006	1" Style 90 Coupling
2806008	1 1/4" Style 90 Coupling
2806010	1 1/2" Style 90 Coupling
2806012	2" Style 90 Coupling

W-R#	Description
2814602	3/4" Style 90 Elbow
2814604	1" Style 90 Elbow
2814606	1 1/4" Style 90 Elbow
2814608	1 1/2" Style 90 Elbow
2814610	2" Style 90 Elbow

W-R#	Description
2806502	3/4" Style 90 Male Adapter
2806504	1" Style 90 Male Adapter
2806506	1 1/4" Style 90 Male Adapter
2806508	1 1/2" Style 90 Male Adapter
2806510	2" Style 90 Male Adapter

- Max Temp: 212°
 - Standard "Seal-Only" Style 90 Fittings can be used for water and gas service where allowed by local codes.

**DRESSER™
PIPELINE SOLUTIONS**

**For Water
Service**

STYLE 118 HANDIBAND® CLAMPS

3" ONE BOLT CLAMPS



W-R#	Diameter x Length	
2817002	1/2" x 3"	Single Bolt
2817006	3/4" x 3"	Single Bolt
2817010	1" x 3"	Single Bolt
2817014	1 1/4" x 3"	Single Bolt
2817018	1 1/2" x 3"	Single Bolt
2817022	2" x 3"	Single Bolt
2817026	2 1/2" x 3"	Single Bolt
2817030	3" x 3"	Single Bolt
2817060	3 1/2" x 3"	Single Bolt
2817034	4" x 3"	Single Bolt
2817039	5" x 3"	Single Bolt
2817038	6" x 3"	Single Bolt
2817043	8" x 3"	Single Bolt

6" TWO BOLT CLAMPS

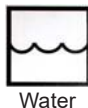

W-R#	Diameter x Length	
2817004	1/2" x 6"	Double Bolt
2817008	3/4" x 6"	Double Bolt
2817012	1" x 6"	Double Bolt
2817016	1 1/4" x 6"	Double Bolt
2817020	1 1/2" x 6"	Double Bolt
2817024	2" x 6"	Double Bolt
2817028	2 1/2" x 6"	Double Bolt
2817032	3" x 6"	Double Bolt
2817062	3 1/2" x 6"	Double Bolt
2817036	4" x 6"	Double Bolt
2817050	5" x 6"	Double Bolt
2817040	6" x 6"	Double Bolt
2817044	8" x 6"	Double Bolt

12" TWO BOLT CLAMPS

Lugs: Ductile Iron
Band: Stainless Steel
Bolts: Brass-Plated Alloy Steel
Gasket: Grade 304 material can be used with water, air, oils, aromatic & aliphatic hydrocarbons, gasoline, & natural gas.

W-R#	Diameter x Length	
2817025	2" x 12"	Double Bolt
2817033	3" x 12"	Double Bolt
2817037	4" x 12"	Double Bolt
2817042	6" x 12"	Double Bolt
2817046	8" x 12"	Double Bolt

- Max Temp: 150°F

**DRESSER™
PIPELINE SOLUTIONS**

**For Water
Service**

**STYLE 360 “ALL-AROUND”
REPAIR CLAMPS**



Lugs: Ductile Iron
Band: Stainless Steel
Bolts: Brass-Plated Alloy Steel
Gasket: Grade 304 material can be used with water, air, oils, aromatic & aliphatic hydrocarbons, gasoline, & natural gas.

- Max Temp: 150°F

for STEEL/PVC [OD] For CAST/DUCTILE [OD]

7.5" LONG CLAMPS

2822500 2" [2.375]	2822702 3" DIP [3.73-4.00]
2822502 3" [3.50]	2822704 4" DIP [4.74-5.14]
2822504 4" [4.50]	2822706 6" DIP [6.84-7.24]
2822506 6" [6.63]	2822708 8" DIP [8.99-9.39]
2822508 8" [8.63]	2822710 10" DIP [11.04-11.44]
2822510 10" [10.75]	2822712 12" DIP [13.10-13.50]
2822512 12" [12.75]	

for STEEL/PVC [OD] For COPPER [OD] For CAST/DUCTILE [OD]

12.5" LONG CLAMPS

2822000 2" [2.375]	2822102 2 1/2" CTS [2.63]	2822202 3" DIP [3.73-4.00]
2822002 3" [3.50]	2822104 3" CTS [3.13]	2822204 4" DIP [4.74-5.14]
2822004 4" [4.50]	2822106 4" CTS [4.13]	2822206 6" DIP [6.84-7.24]
2822006 6" [6.63]		2822208 8" DIP [8.99-9.39]
2822008 8" [8.63]		2822210 10" DIP [11.04-11.44]
2822010 10" [10.75]		2822212 12" DIP [13.10-13.50]
2822012 12" [12.75]		

**DRESSER™
PIPELINE SOLUTIONS**

**For Gas
Service**

**STYLE 39 COUPLING FOR STEEL--INSULATED,
FOR GAS APPLICATIONS**

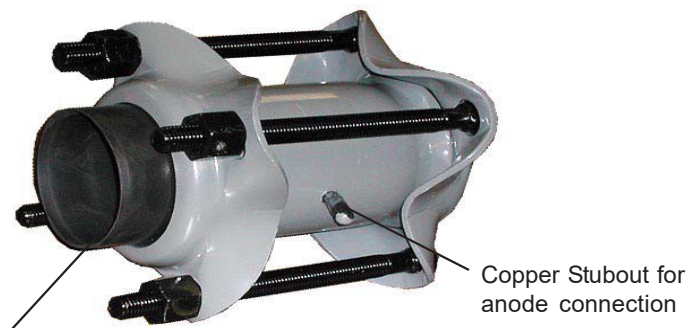

Insulating Sleeve



Insulating Sleeve,
Gasket, & Spacer



Gas

W-R#	Description	Insulating Sleeve
2803000	2" IPS	One-End
2803002	2½" IPS	One-End
2803004	3" IPS	One-End
2803006	4" IPS	One-End
2803007	5" IPS	One-End
2803008	6" IPS	One-End
2803010	8" IPS	One-End

- Features rubber insulating sleeve and anode for conductivity
- Fusion-bonded epoxy coat.
- Style 39 couplings are "Seal-Only"--for aboveground use (meter set)

**STYLE 711 BOLTED COUPLINGS
WITH "RESTRAINING SEAL"
FOR STEEL PIPE**

Pullout Prevention Products

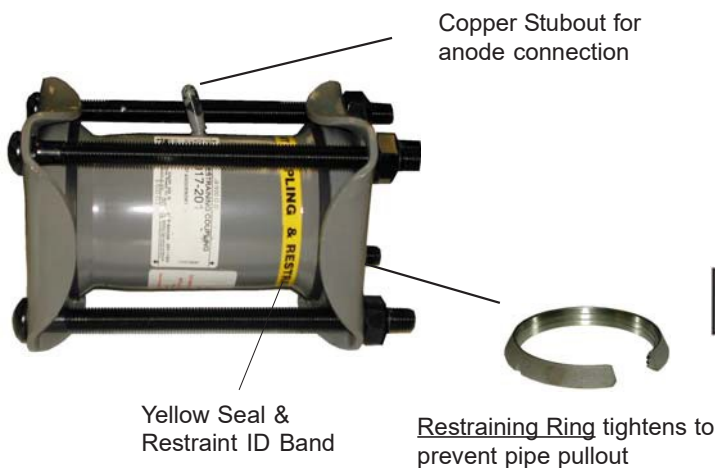

Yellow Seal &
Restraint ID Band

Restraining Ring tightens to
prevent pipe pullout



Gas

W-R#	Description
2833002	2" IPS - Steel Pipe
2833006	3" IPS - Steel Pipe
2833008	4" IPS - Steel Pipe

W-R#	Description
2834002	2" IPS - *PE* SDR-11
2834005	3" IPS - *PE* SDR-11
2834006	3" IPS - *PE* SDR-11.5
2834007	4" IPS - *PE* SDR-11
2834008	4" IPS - *PE* SDR-11.5

- furnished with 2 heavy steel stiffeners

**DRESSER™
PIPELINE SOLUTIONS**

**For Gas
Service**

**STYLE 90 "SEAL ONLY" FITTING FOR STEEL PIPE,
INSULATED FOR GAS**



Cast Iron Body

1/8" tap



Machined Steel Body with tap



Insulating Sleeve,
Gasket, & Spacer

W-R# Description

2815802	3/4"	Insulated Coupling
2815804	1"	Insulated Coupling
2815806	1 1/4"	Insulated Coupling
2815808	1 1/2"	Insulated Coupling
2815810	2"	Insulated Coupling

- Insulating sleeve and spacer to conform to local codes.
- Seal Only--no restraint.

W-R# Description

2820002	3/4"	Insulated Cplg w/ Tap
2820004	1"	Insulated Cplg w/ Tap
2820006	1 1/4"	Insulated Cplg w/ Tap
2820008	1 1/2"	Insulated Cplg w/ Tap
2820010	2"	Insulated Cplg w/ Tap

- Insulated coupling with 1/8" tapping to meet Con Ed specs.
- Heavy-duty machined-steel body.
- Seal Only--no restraint.

W-R# Description

2816002	3/4"	Insulated Elbow
2816004	1"	Insulated Elbow
2816006	1 1/4"	Insulated Elbow
2816008	1 1/2"	Insulated Elbow
2816010	2"	Insulated Elbow

- Seal Only--no restraint.

**DRESSER™
PIPELINE SOLUTIONS**

**For Gas
Service**

**“UNIVERSAL” STYLE 90 COUPLINGS
WITH “RESTRAINING SEAL”**



FOR STEEL

Pullout Prevention Products

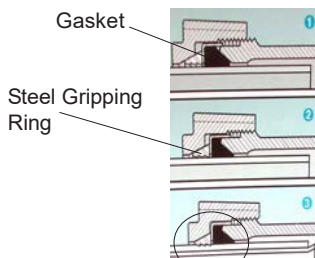
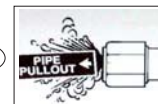

Upon tightening nut, gasket compresses to create seal and steel rings grip pipe to prevent pullout.



Steel Gripping Ring



W-R#	Description
2816602	¾" "Universal" Coupling
2816604	1" "Universal" Coupling
2816606	1¼" "Universal" Coupling
2816608	1½" "Universal" Coupling
2816610	2" "Universal" Coupling

- Seal & Restraint coupling

FOR POLYETHYLENE



Furnished with stiffeners



W-R#	Description	SDR
2817702	¾" "Universal"	11
2817704	1" "Universal"	11
2817706	1¼" "Universal"	10
2817708	1½" "Universal"	11
2817710	2" "Universal"	11

- Seal & Restraint coupling

**DRESSER™
PIPELINE SOLUTIONS**

**For Hi-Temp
Applications**

STYLE 38 HI-TEMP COUPLINGS



Max Temp: 1200°



Carded Glass Gasket



W-R#	Description	OD
2801489	1/2" IPS	[.84]
2801490	3/4" IPS	[1.05]
2801492	1" IPS	[1.32]
2801494	1 1/4" IPS	[1.66]
2801496	1 1/2" IPS	[1.90]
2801498	2" IPS	[2.38]
2801500	2 1/2" IPS	[2.88]
2801502	3" IPS	[3.50]
2801503	3 1/2" IPS	[4.00]
2801504	4" IPS	[4.50]
2801506	5" IPS	[5.563]
2801508	6" IPS	[6.63]
2801510	8" IPS	[8.63]
2801512	10" IPS	[10.75]
2801514	12" IPS	[12.75]

- Carded Fiberglass. Withstands temperatures to 1200°. Please note: the non-resilient characteristic of carded fiberglass gaskets can result in a non-leakproof seal.

STYLE 90 HI-TEMP COUPLINGS



Max Temp: 1200°



Carded Glass Gasket



W-R#	Description
2814402	1/2" Style 90 - Hi Temp
2814404	3/4" Style 90 - Hi Temp
2814406	1" Style 90 - Hi Temp
2814408	1 1/4" Style 90 - Hi Temp
2814410	1 1/2" Style 90 - Hi Temp
2814412	2" Style 90 - Hi Temp

- Carded Fiberglass. Withstands temperatures to 1200°. Please note: the non-resilient characteristic of carded fiberglass gaskets can result in a non-leakproof seal.

**DRESSER™
PIPELINE SOLUTIONS**



**STYLE 175 GTO/CURB
VALVES**



W-R# Description

2817112	3/4"	#175 GTO Valve
2817114	1"	#175 GTO Valve
2817116	1 1/4"	#175 GTO Valve
2817118	1 1/2"	#175 GTO Valve
2817120	2"	#175 GTO Valve

- FIP x FIP
- Tamper-proof design
- 1/4 Turn



**STYLE 275 LOCK WING
METER VALVES**

W-R# Description

2817150	3/4"	#275 Lockwing
2817152	1"	#275 Lockwing
2817154	1 1/4"	#275 Lockwing

- FIP x FIP
- Tamper-proof design



**STYLE 91 SERVICE
SADDLES**

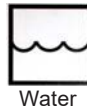

W-R# Description

2807001	2" X 1"
2807002	2" X 1 1/4"
2807004	2" X 1 1/2"
2807005	2 1/2" X 1"
2807006	2 1/2" X 1 1/4"
2807048	4" X 1 1/2"
2807012	4" X 2"

- Double Stirrup design
- Max Temp 212°



**STYLE 62 - TYPE 2
REDUCING COUPLING
FOR STEAM SERVICE**



W-R# Description

2827002	8" x 2" Style 62-Type II
2827004	10" x 3" Style 62-Type II
2827006	12" x 4" Style 62-Type II
2827008	16" x 6" Style 62-Type II
2827010	18" x 8" Style 62-Type II
2827012	20" x 10" Style 62-Type II
2827014	24" x 12" Style 62-Type II

- Ref: ConEd Specification E0-9380-C

**DRESSER™
PIPELINE SOLUTIONS**

**Parts for
Style 38
Couplings**



**WATER
SERVICE**

Plain Grade 27
Buna-S gasket

W-R#	Description
2817602	1/2"
2817604	3/4"
2817606	1"
2817608	1 1/4"
2817610	1 1/2"
2817612	2"
2817614	2 1/2"
2817616	3"
2817618	3 1/2"
2817620	4"
2817622	5"
2817624	6"
2817626	8"
2817628	10"
2817630	12"



**GAS
SERVICE**

Armored Grade 27
Buna-S gasket.
Brass coil provides
additional conductivity.

W-R#	Description
2817502	1/2"
2817504	3/4"
2817506	1"
2817508	1 1/4"
2817510	1 1/2"
2817512	2"
2817514	2 1/2"
2817516	3"
2817518	3 1/2"
2817520	4"
2817522	5"
2817524	6"
2817526	8"
2817528	10"
2817530	12"



**OIL
SERVICE**

Grade 42 BUNA-N
Gaskets for fuel oil &
gasoline.

W-R#	Description
2801462	2"
2801464	2 1/2"
2801466	3"
2801467	3 1/2"
2801468	4"
2801470	5"
2801472	6"
2801474	8"
2801476	10"
2801478	12"



**HI-TEMP
CARDED GLASS**

For steam & air
applications up to 1200°.
Please note: the non-
resilient characteristic of
carded fiberglass gaskets
can result in a non-leakproof
seal.

W-R#	Description
2817276	1/2"
2817278	3/4"
2817280	1"
2817282	1 1/4"
2817284	1 1/2"
2817286	2"
2817288	2 1/2"
2817302	3"
2817303	3 1/2"
2817304	4"



NUTS & BOLTS

Dresserloy® Carbon Steel Epoxy-
coated bolts & nuts

W-R#	Description
2818312	5/8" x 8 1/4" Nut & Bolt
2818314	5/8" x 10 3/4" Nut & Bolt

- Also available in 304 Stainless Steel
and 316 Stainless Steel

**DRESSER™
LEGACY PRODUCTS**



**ROOTS®
SERIES B3
ROTARY METERS**

W-R#	Fig#	Capacity
2840002	8C175-CTR	800 CFH
2840102	11C175-CTR	1000 CFH
2840202	15C175-CTR	1500 CFH
2840302	3M175-CTR	3000 CFH
2840402	5M175-CTR	5000 CFH

- Standard, non-compensated counter
- Other sizes & configurations available. Contact our Dresser specialists for more information.



**RCS®
MAR-SERIES
90° VALVE ACTUATORS**

W-R#	Fig#	Timing
2841010	MAR-10-10	10 SEC/90°
2841050	MAR-50-10	10 SEC/90°
2841090	MAR-90-15	15 SEC/90°

- For on/off and modulating control of part-turn ball, butterfly or plug valves.



**CONSOLIDATED®
2478 SERIES
PRESSURE RELIEF
VALVE**

W-R#	Size	Pressure
2841202	3/4"	100 PSI
2841204	1"	100 PSI
2841206	1 1/4"	100 PSI
2841208	1 1/2"	100 PSI
2841210	2"	100 PSI

- Other sizes & configurations available. Contact our Dresser specialists for more information.



**CONSOLIDATED®
19110M SERIES
PRESSURE RELIEF
VALVE**

W-R#	Size	Pressure
2841402	1/2"	100 PSI
2841404	3/4"	100 PSI
2841406	1"	100 PSI

- Other sizes & configurations available. Contact our Dresser specialists for more information.



**ROOTS®
URAI SERIES
ROTARY LOBE
BLOWERS**

W-R#	Frame Size	Figure#
2841606	32"	32 URAI
2841612	42"	42 URAI

- Other sizes & configurations available. Contact our Dresser specialists for more information.

**PIPE CONNECTIONS
& REPAIR**

**WAL-RICH HINGED
STEEL PIPE CLAMP**



W-R#	Description	Min	Box
2206002	1/2"	1	5
2206006	3/4"	1	5
2206010	1"	1	5
2206014	1 1/4"	1	5
2206018	1 1/2"	1	5
2206022	2"	1	1
2206026	2 1/2"	1	1
2206030	3"	1	1



**STEEL REPAIR PLATES
WITH "U" BOLT**

W-R#	Description	Min	Box
2204002	2"	1	6
2204004	3"	1	6
2204006	4"	1	6
2204008	5"	1	6



**STAINLESS STEEL
WRAP-AROUND
REPAIR CLAMPS**



SIZE IPS (CTS)	SHORT (3") ONE-BOLT	LONG (6") TWO-BOLT
3/8" (1/2" CTS)	2206102	2206202
1/2" (3/4" CTS)	2206104	2206204
3/4" (1" CTS)	2206106	2206206
1" (1 1/4" CTS)	2206108	2206208
1 1/4" (1 1/2" CTS)	2206110	2206210
1 1/2"	2206112	2206212
2"	2206114	2206214
2 1/2"	2206116	2206216
3"	2206118	2206218
4"	2206120	2206220



**CAST IRON TAPPED
SADDLE TEE**

W-R#	Description	Min	Box
0422010	4" x 2"	1	12

**PIPE CONNECTIONS
& BRASS WATER
SERVICE FITTINGS**



**W-R GALVANIZED
MALLEABLE IRON
COMPRESSION
COUPLING**

DIA.	SHORT	(LENGTH)	LONG	(LENGTH)
1/2"	2560002	2 3/4"	2561002	4 1/4"
3/4"	2560004	3"	2561004	4 1/4"
1"	2560006	3 1/4"	2561006	4 1/2"
1 1/4"	2560008	3 1/4"	2561008	4 3/4"
1 1/2"	2560010	3 1/4"	2561010	5"
2"	2560012	3 1/2"	2561012	5 1/4"
2 1/2"	2560014	4"	2561014	5 3/4"
3"	2560016	4 1/2"	2561016	7"

- 125 psi at 120°
- Imported



**W-R BRASS
COMPRESSION
COUPLINGS
- LEAD FREE -**

SHORT (3")	LONG (5")	IPS	COPPER
4531000	4532000	3/8"	1/2"
4531002	4532002	1/2"	3/4"
4531004	4532004	3/4"	1"
4531006	4532006	1"	
4531008	4532008	1 1/4"	
4531010	4532010	1 1/2"	
4531012	4532012	2"	

- 125 psi at 180°
- Imported



**AA LEAD X MIPS
PACK-JOINT ADAPTER
- LEAD FREE -**

W-R#	Description
4819002	5/8" AA x 3/4" MIPS
4819004	3/4" AA x 3/4" MIPS
4819006	1" AA x 1" MIPS
4819008	1 1/4" AA x 1 1/4" MIPS



**COPPER X MIPS
PACK-JOINT ADAPTER
- LEAD FREE -**

W-R#	Description
4819204	3/4" Cop x 3/4" MIPS
4819206	1" Cop x 1" MIPS
4819208	1 1/4" Cop x 1 1/4" MIPS
4819210	1 1/2" Cop x 1 1/2" MIPS
4819212	2" Cop x 2" MIPS

BRASS WATER SERVICE FITTINGS



**COPPER X COPPER
PACK-JOINT ADAPTER**
- LEAD FREE -

W-R#	Description
4819104	3/4" Cop x 3/4" Cop
4819106	1" Cop x 1" Cop
4819108	1 1/4" Cop x 1 1/4" Cop
4819110	1 1/2" Cop x 1 1/2" Cop
4819112	2" Cop x 2" Cop



**FLARE X FLARE
ADAPTER**
- LEAD FREE -

W-R#	Description
4819402	3/4" Flare x 3/4" Flare
4819404	1" Flare x 1" Flare



**FLARE X MALE IPS
ADAPTER**
- LEAD FREE -

W-R#	Description
4819502	3/4" Flare x 3/4" MIP
4819504	1" Flare x 1" MIP



**WATER METER
COUPLINGS WITH
WASHER**
- LEAD FREE -

W-R#	Description	Min.	Box
4429002	5/8"	1 pair/bag	20
4429004	3/4"	1 pair/bag	20
4429005	1"	1 pair/bag	10



4429072	5/8"	1 each	24
4429074	3/4"	1 each	24
4429075	1"	1 each	12



**WATER METER
COUPLING WASHERS**

W-R#	Description	Min.	Box
2725004	1/2"	12	12
2725006	3/4"	12	12
2725008	1"	12	12

- Rubber



**BRASS WATER METER
FLANGE SET**
- LEAD FREE -

W-R#	Description	Min.	Box
4429502	1 1/2"	1	-
4429504	2"	1	-

- Boxed with 2 flanges, nuts, bolts, & gaskets

**PIPE CONNECTIONS
& REPAIR**

**RUBBER TRANSITION
COUPLINGS**



W-R#	Description	Min	Box
2533001	1 1/4" x 1 1/4"	1	40
2533002	1 1/2" x 1 1/4"	1	40
2533004	1 1/2" x 1 1/2"	1	40
2533006	2" x 1 1/2"	1	20
2533008	2" x 2"	1	20
2533012	3" x 2"	1	20
2533014	3" x 3"	1	20
2533015	4" x 2"	1	20
2533016	4" x 3"	1	20
2533018	4" x 4"	1	10
2533020	6" x 4"	1	10
2533022	6" x 6"	1	4

- Sizes listed are for Schedule 40 Steel, Cast Iron, and PVC

**RUBBER TRANSITION
DONUTS**



W-R#	Description	Min	Box
2533500	2" x 1 1/2"	1	20
2533502	2" x 2"	1	20
2533506	3" x 2"	1	20
2534000	3" x 3"	1	10
2535000	4" x 3"	1	10
2536000	4" x 4"	1	10

**RUBBER DRAIN AND
TRAP CONNECTION**



W-R#	Description
1662002	1 1/2" Sch 40 x 1 1/2" tubular
1662004	2" Sch 40 x 1 1/2" tubular
1662006	1 1/2" tubular x 1 1/2" tubular

- Drain and trap connections are 12 per box, with a one piece minimum.

**RUBBER WASHING
MACHINE HOSE GRIPS**



W-R#	Description	Min	Box
2533000	1 1/2"	1	12

• Fits 2" or 1 1/2" standpipe x 1" to 1 7/16" washing machine discharge hose.

**PIPE CONNECTIONS
& REPAIR**



ECONO-PLUGS

W-R#	Size	Min	Box
1837220	1½"	1	25
1837222	2"	1	25
1837224	3"	1	25
1837226	4"	1	25
1837228	6"	1	25



ECONO-CAPS

W-R#	Size	Min	Box
1837502	1½"	1	25
1837504	2"	1	25
1837506	3"	1	25
1837508	4"	1	25



Unique flanged design

**RED-RUBBER
TEST PLUG**

W-R#	Size	Min	Box
1837200	1½"	1	25
1837202	2"	1	25
1837204	3"	1	25
1837206	4"	1	25



NO-HUB COUPLINGS



W-R#	Description	Min	Box
2540002	1 1/2" X 1 1/2"	1	20
2540004	2" X 2"	1	20
2540006	2" X 1 1/2"	1	20
2540008	3"	1	20
2540010	4"	1	20

- Imported

**PIPE CONNECTIONS
& REPAIR**



**SKINNER®
EMERGENCY PIPE
CLAMPS**

W-R#	Description	Min	Box
2641002	1/2"	1	5
2641004	3/4"	1	5
2641006	1"	1	5
2641008	1 1/4"	1	5
2641010	1 1/2"	1	5
2641012	2"	1	1
2641014	2 1/2"	1	1
2641016	3"	1	1
2641018	3 1/2"	1	1
2641020	4"	1	1
2641022	5"	1	1
2641024	6"	1	1

- Temperature rating: up to 250°F
- Pressure Rating: up to 600 psi
- Buna N gasket can be used on water, gas, & oil.



**KRAUSZ® "HYMAX"
WIDE-RANGE
TRANSITION
COUPLINGS**

W-R#	Nom	Low Range	High Range
2630002	2"	(2.10-2.60)	(2.56-3.03)
2630004	3"	(3.46-3.90)	(3.86-4.33)
2630006	4"	(4.25-5.00)	(4.92-5.63)
2630007	5"	(5.12-5.75)	(5.71-6.38)
2630008	6"	(6.42-7.05)	(7.01-7.68)
2630010	8"	(8.54-9.17)	(9.13-9.84)
2630012	10"	(10.70-11.37)	(11.33-12.00)
2630014	12"	(12.40-13.03)	(12.99-13.66)

- Wide range allows for transitions between cast iron, steel, PVC, & HDPE pipe.
- For water service only
- Temperature range: -20°F - 220°F
- Pressure rating: up to 260 psi



Patented 2-layer gasket pulls away to enable hi-range.



**EASYFIT®
ISOLATION VALVES FOR
COPPER PIPE**

W-R#	Description
1735002	1/2" EasyFit valve
1735004	3/4" EasyFit valve
1735006	1" EasyFit valve

- EasyFit isolation valves are a hot-tap and shutoff all-in-one.
- For water service only
- Limited geographical distribution. Call for details.



GAS METER SPECIALTIES



**SIDE-IN / TOP-OUT
METER BARS**



W-R#	Length	Inlet	Outlet	Swivel	Class
0418002	6"	1"	1"	1"	250
0418004	6 1/2"	1"	1"	1"	250
0418006	7"	1 1/4"	1 1/4"	1 1/4"	400

- Keyspan/National Grid pattern



**SIDE-IN / SIDE-OUT
METER BARS**



W-R#	Length	Inlet	Outlet	Swivel	Class
0419002	6"	1"	1"	1"	250
0419004	8 1/4"	1"	1 1/4"	1 1/4"	400



**BALL VALVE
METER BARS**



W-R#	Length	Inlet	Outlet	Swivel	Class
0423002	6"	1"	1"	1"	250



**MALLEABLE IRON
INSULATED UNIONS**



W-R#	Size (NPT)	Finish
0417702	3/4"	Black
0417704	1"	Black
0417706	1 1/4"	Black
0417708	1 1/2"	Black
0417710	2"	Black

0415402	3/4"	Galvanized
0415404	1"	Galvanized
0415406	1 1/4"	Galvanized
0415408	1 1/2"	Galvanized
0415410	2"	Galvanized

- Flat Insulating Washer



**GAS REGULATOR
VENTS
("PECK" VENTS)**

W-R#	Description
1754002	3/4" With Screen
1754004	1" With Screen
1754006	1 1/4" With Screen
1754008	1 1/2" With Screen
1754010	2" With Screen

GAS METER SPECIALTIES



1" Offset

OFFSET SWIVELS FOR GAS METERS

W-R#	Size (NPT)	LT.	Finish
0416602	3/4"	10	Black
0416604	1"	20	Black
0416606	1 1/4"	30	Black



NUTS FOR GAS METERS

W-R#	Size (NPT)	LT.	Finish
0416802	3/4"	10	Black
0416804	1"	20	Black
0416806	1 1/4"	30	Black



STRAIGHT SWIVELS FOR GAS METERS

W-R#	Size (NPT)	LT.	Finish
0416902	3/4"	10	Black
0416904	1"	20	Black
0416906	1 1/4"	30	Black



METER BAR ADAPTER

W-R#	Size (NPT)	Min	Box
0423702	1 1/4" x 1"	1	-



METER PLUGS WITH TAP

W-R#	Size (NPT)	LT.	Tap Size
0418802	3/4"	10	1/8"
0418802	1"	20	1/8"
0418804	1 1/4"	30	1/4"



RUBBER WASHER FOR METER BAR

W-R#	Size (NPT)	LT.
0417602	3/4"	10
0417604	1"	20
0417606	1 1/4"	30

GAS METER SPECIALTIES



LOCKWING GAS COCK

BLACK

W-R#	Description	PSI	Min	Box
0416002	3/4"	175	1	25
0416004	1"	175	1	15
0416006	1 1/4"	175	1	10
0416008	1 1/2"	175	1	5
0416010	2"	175	1	5

- FIP x FIP
- Tamper-proof design



**DRESSER STYLE 275®
LOCKWING GAS METER
VALVES**

BLACK

W-R#	Description
2817150	3/4" #275 Lockwing
2817152	1" #275 Lockwing
2817154	1 1/4" #275 Lockwing

- FIP x FIP
- Tamper-proof design



**FLOWSERVE®
LUBRICATED PLUG
VALVES**

W-R#	Description
0424112	2" #142 Plug Valve
0424116	3" #142 Plug Valve
0424120	4" #142 Plug Valve

- FIP x FIP
- Iron Body Lubricated Plug Valve
- Short Pattern
- 200 psi CWP (Cold Working Pressure)



W-R#	Description
0425001	2" #142T Tamperproof
0425002	3" #142T Tamperproof
0425004	4" #142T Tamperproof

- FIP x FIP
- Iron Body Lubricated Plug Valve
- Short Pattern
- 200 psi CWP (Cold Working Pressure)
- ConEd pattern

GAS METER SPECIALTIES



**IMAC SYSTEMS
CARBON STEEL
FLANGED Y-STRAINER**



W-R#	Description	OEM#
1756002	2"	YS-61-CS

- Con-Ed requirement as of 7/15
- 150# Raised Face Flanges
- Less blow-off & gauge tap plugs
- 40 mesh internal strainer



**CARBON STEEL
150# FLAT FACE
FLANGES**

W-R#	Description
1757004	2"
1757006	2 1/2"
1757008	3"
1757010	4"



**GARLOCK 3000®
RING GASKET
STRAINERS**

W-R#	Description	Type
2745002	2"	Ring
2745004	3"	Ring
2745006	4"	Ring
2745008	6"	Ring

- 60 mesh gasket strainer
- Non-asbestos gasket



**GARLOCK 3000®
GASKETS**

Size	Ring	Full Face
2"	2744002	2744052
3"	2744004	2744054
4"	2744006	2744056
6"	2744008	2744058

- Non-asbestos gasket



**COMPANION FLANGE
ISOLATION KITS FOR
NATURAL GAS**

W-R#	Description	Type
2746002	2"	Full Face
2746006	3"	Full Face
2746008	4"	Full Face

- Phenolic gasket, sleeves, & washers
- Made in USA

SPECIALTY WASHERS



RING GASKET



Fiber	Size	Rubber	OD	ID
2737002	1 1/2"	2737102	3 1/4	1 7/8
2737004	2"	2737104	4	2 1/4
2737006	2 1/2"	2737106	4 3/4	2 3/4
2737008	3"	2737108	5 3/8	3 1/2
2737010	3 1/2"	2737110	6 1/4	3 7/8
2737012	4"	2737112	6 7/8	4 3/8
2737014	5"	2737114	7 3/4	5 1/2
2737016	6"	2737116	8 7/8	6 1/2

- Fiber gaskets are 1/16" thick (150#)
- Fiber gaskets rated to 500° F.
- **Rubber** gaskets are 1/8" thick (150#)



COMPANION FLANGE GASKET



Fiber	Size	Rubber	OD	ID
2739000	1 1/2"	2739100	4 7/8	1 3/4
2739002	2"	2739102	6	2 1/4
2739004	2 1/2"	2739104	7	2 3/4
2739006	3"	2739106	7 1/2	3 3/8
2739008	3 1/2"	2739108	8 1/2	3 7/8
2739010	4"	2739110	9	4 3/8
2739012	5"	2739112	9 7/8	5 1/2
2739014	6"	2739114	11	6 1/2

- Fiber gaskets are 1/16" thick (150#)
- Fiber gaskets rated to 500° F.
- **Rubber** gaskets are 1/8" thick (150#)



RING GASKET, BOLT, & NUT PACKS

Fiber	Size	Rubber	Bolt Size	# Bolts
2737504	2"	2737704	5/8" x 3"	4
2737506	2 1/2"	2737706	5/8" x 3"	4
2737508	3"	2737708	5/8" x 3"	4
2737512	4"	2737712	5/8" x 3"	8
2737514	5"	2737714	3/4" X 3 1/4"	8
2737516	6"	2737716	3/4" X 3 1/4"	8

- Fiber gaskets are 1/16" thick (150#)
- Fiber gaskets rated to 500° F.
- **Rubber** gaskets are 1/8" thick (150#)



COMPANION FLANGE GASKET, BOLT, & NUT PACKS

Fiber	Size	Rubber	Bolt Size	# Bolts
2739202	2"	2739402	5/8" x 3"	4
2739204	2 1/2"	2739404	5/8" x 3"	4
2739206	3"	2739406	5/8" x 3"	4
2739210	4"	2739410	5/8" x 3"	8
2739212	5"	2739412	3/4" X 3 1/4"	8
2739214	6"	2739414	3/4" X 3 1/4"	8

- Fiber gaskets are 1/16" thick (150#)
- Fiber gaskets rated to 500° F.
- **Rubber** gaskets are 1/8" thick (150#)

SPECIALTY WASHERS



HEX BOLT & NUT SET

W-R#	Description	Box
2402502	5/8" x 2 3/4" w/nut	12 bolts/nuts
2402504	5/8" x 3" w/nut	12 bolts/nuts
2402506	3/4" x 3" w/nut	12 bolts/nuts
2402508	3/4" x 3 1/4" w/nut	12 bolts/nuts



RED RUBBER (SBR) SQUARE-PAK

W-R#	Description	Thickness	Min
1910002	6" x 6"	1/16"	12
1910004	12" x 12"	1/16"	12



RED RUBBER PACKING SHEET

W-R#	Description	Min
1909002	1/16" (3' X 60')	100 lbs
1909014	1/8" (3' X 27')	100 lbs

-20 to 170° Fahrenheit



NON-ASBESTOS GASKETING MATERIAL

W-R#	Description	Thickness	Min
1904002	60" x 60"	1/16"	1
1904004	30" x 30"	1/16"	1



- Rated at up to 1200°F



CIRCULATOR FLANGE GASKETS

W-R#	Description	Min	Box
1751002	Pair/bag	1 pr.	50 pr.
A000337	Bulk	100	100



- 1 1/2" ID center, 1/2" ID screw holes
- 1/8" Red SBR rubber
- Fits B&G, Taco, and most other circulators



CIRCULATOR FLANGE REPAIR KIT

W-R#	Description	Box
1751004	Gasket/Nuts/Bolt Kit	6



- Package contains:
 - (4) 7/16" 14T bolts
 - (4) 7/16" hex nuts
 - (2) A000337 gaskets
- Fits B&G, Taco, and most popular circulators.
- Bagged



CIRCULATOR FLANGE NUTS AND BOLTS

W-R#	Description	Box
1751006	Nut/Bolt Kit	6



- Package contains:
 - (4) 7/16" 14T bolts
 - (4) 7/16" hex nuts
 - (2) A000337 gaskets



Con-Stab ID Seal® Fittings have been sold in the gas, plumbing, and propane markets since 1990. **Con-Stab®** fittings are IAPMO, CSA, & ICC approved.



for: **Pool Heaters**



for: **Gas Grills**



for: **Patio Hearths & Lighting**



for: **Emergency Generators**

CON-STAB® ANODELESS

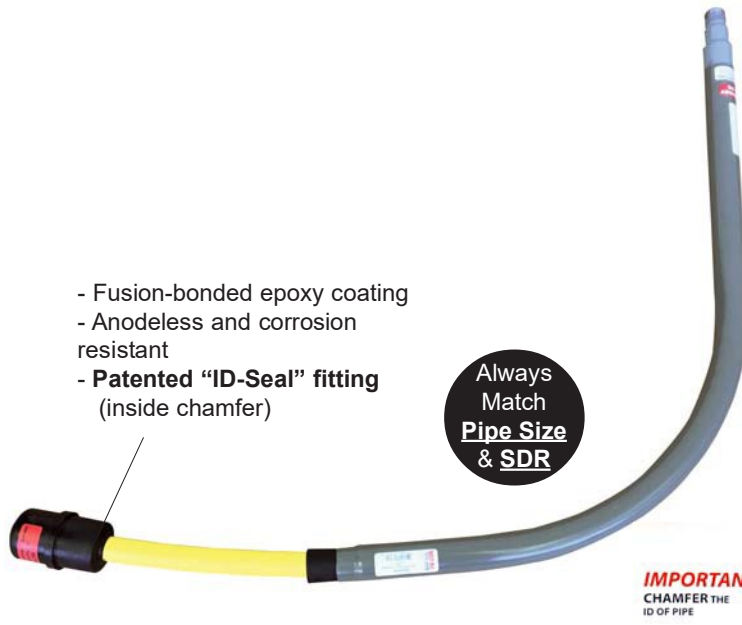

- Fusion-bonded epoxy coating
- Anodeless and corrosion resistant
- **Patented "ID-Seal" fitting** (inside chamfer)

Always Match **Pipe Size & SDR**

IMPORTANT
CHAMFER THE ID OF PIPE

W-R	Size	Wall (CTS) or SDR
2886036	1/2" CTS	.090
2886025	1/2" IPS	SDR-9.3
2886004	3/4" IPS	SDR-11
2886008	1" IPS	SDR-11
2886040	1" CTS	.099/.101
2886012	1 1/4" IPS	SDR-10
2886013	1 1/4" IPS	SDR-11
2886016	1 1/2" IPS	SDR-11
2886020	2" IPS	SDR-11

You must use a **Continental Chamfer Tool** on a **Continental Fitting!**



POLY-END ANODELESS METER RISERS

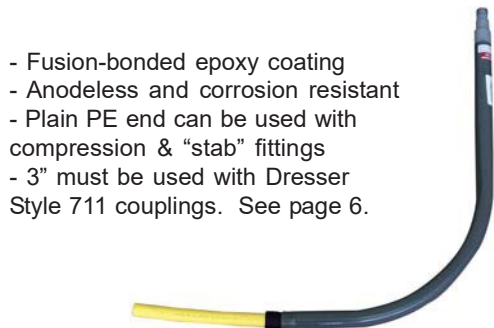

- Fusion-bonded epoxy coating
- Anodeless and corrosion resistant
- Plain PE end can be used with compression & "stab" fittings
- 3" must be used with Dresser Style 711 couplings. See page 6.

Sleeved Elbow Unit
2886060 2"
2886070 3"
2886080 4"

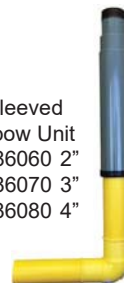

W-R	Size	Wall (CTS) or SDR
2886002	3/4" IPS	SDR-11
2886006	1" IPS	SDR-11
2886030	1" CTS	.099/.101
2886010	1 1/4" IPS	SDR-10
2886011	1 1/4" IPS	SDR-11
2886014	1 1/2" IPS	SDR-11
2886018	2" IPS	SDR-11

2886060	2" IPS	SDR-11
2886070	3" IPS	SDR-11.5
2886080	4" IPS	SDR-11.5



Con-Stab ID Seal® Fittings have been sold in the gas, plumbing, and propane markets since 1990. **Con-Stab®** fittings are IAPMO, CSA, & ICC approved.



CON-STAB® COUPLINGS

Always Match Pipe Size & SDR



W-R	Size	Wall (CTS) or SDR
2881000	1/2" CTS	.090
2881025	1/2" IPS	SDR-9.3
2881002	3/4" IPS	SDR-11
2881004	1" IPS	SDR-11
2881020	1" CTS	.099/.101
2881006	1 1/4" IPS	SDR-10
2881007	1 1/4" IPS	SDR-11
2881008	1 1/2" IPS	SDR-11
2881010	2" IPS	SDR-11



CON-STAB® ELBOWS

Always Match Pipe Size & SDR



W-R	Size	Wall (CTS) or SDR
2882000	1/2" CTS	.090
2882025	1/2" IPS	SDR-9.3
2882002	3/4" IPS	SDR-11
2882004	1" IPS	SDR-11
2882020	1" CTS	.099/.101
2882006	1 1/4" IPS	SDR-10
2882007	1 1/4" IPS	SDR-11
2882008	1 1/2" IPS	SDR-11
2882010	2" IPS	SDR-11



CON-STAB® TEES

Always Match Pipe Size & SDR



W-R	Size	Wall (CTS) or SDR
2883000	1/2" CTS	.090
2883025	1/2" IPS	SDR-9.3
2883002	3/4" IPS	SDR-11
2883004	1" IPS	SDR-11
2883020	1" CTS	.099/.101
2883006	1 1/4" IPS	SDR-10
2883007	1 1/4" IPS	SDR-11
2883008	1 1/2" IPS	SDR-11
2883010	2" IPS	SDR-11



Con-Stab ID Seal® Fittings have been sold in the gas, plumbing, and propane markets since 1990. **Con-Stab®** fittings are IAPMO, CSA, & ICC approved.

CON-STAB® MALE ADAPTERS



Always Match **Pipe Size & SDR**



W-R	Size	Wall (CTS) or SDR
2885000	1/2" CTS	.090
2885025	1/2" IPS	SDR-9.3
2885002	3/4" IPS	SDR-11
2885004	1" IPS	SDR-11
2885020	1" CTS	.099/.101
2885006	1 1/4" IPS	SDR-10
2885007	1 1/4" IPS	SDR-11
2885008	1 1/2" IPS	SDR-11
2885010	2" IPS	SDR-11

- Standard sizes with 4" long steel MIP stub.

POLY PLAIN-END MALE ADAPTERS



Always Match **Pipe Size & SDR**



W-R	Size	Wall (CTS) or SDR
2885050	3/4" IPS	SDR-11
2885052	1" IPS	SDR-11
2885070	1" CTS	.099/.101
2885054	1 1/4" IPS	SDR-10
2885055	1 1/4" IPS	SDR-11
2885056	1 1/2" IPS	SDR-11
2885058	2" IPS	SDR-11

- Standard sizes with 4" long steel MIP stub.
 - Plain End can be used with stab couplings, compression couplings, and fusion fittings.



CON-STAB® CHAMFER TOOL

Always Match **Pipe Size & SDR**

W-R	Size	Wall (CTS) or SDR
2888020	1/2" CTS	.090
2888025	1/2" IPS	SDR-9.3
2888014	3/4" IPS	SDR-11
2888016	1" IPS	SDR-11
2888022	1" CTS	.099/.101
2888006	1 1/4" IPS	SDR-10
2888007	1 1/4" IPS	SDR-11
2888008	1 1/2" IPS	SDR-11
2888010	2" IPS	SDR-11

- **Follow the Arrow!** Turn the tool in the direction of the arrow printed on the tool for a clean, even chamfer (bevel) on the inside of the pipe.

LOOK FOR THE "C"

You must use a **Continental** Chamfer Tool on a **Continental** Fitting!



Con-Stab ID Seal® Fittings have been sold in the gas, plumbing, and propane markets since 1990. **Con-Stab®** fittings are IAPMO, CSA, & ICC approved.



CON-STAB® x COPPER TRANSITION FITTING

Always Match Pipe Size & SDR



W-R	Con-Stab®	Copper Tube
2884002	3/4" IPS SDR-11	1/2" Flare
2884004	1/2" CTS .090	1/2" Flare

- Con-Stab® x Flare connection for copper tubing



CON-STAB® REDUCING COUPLINGS

IPS X IPS

Always Match Pipe Size & SDR



W-R	IPS X IPS REDUCERS
2891035	3/4" SDR11 x 1/2" SDR-9

2891030	1" SDR11 x 3/4" SDR11
---------	-----------------------

2891049	1 1/4" SDR10 x 3/4" SDR11
2891021	1 1/4" SDR10 x 1" SDR11
2891008	1 1/4" SDR10 x 1 1/4" SDR11

2891050	1 1/4" SDR11 x 3/4" SDR11
2891022	1 1/4" SDR11 x 1" SDR11

2891010	1 1/2" SDR11 x 3/4" SDR11
2891012	1 1/2" SDR11 x 1" SDR11
2891013	1 1/2" SDR11 x 1 1/4" SDR10
2891014	1 1/2" SDR11 x 1 1/4" SDR11

2891002	2" SDR11 x 3/4" SDR11
2891004	2" SDR11 x 1" SDR11
2891005	2" SDR11 x 1 1/4" SDR10
2891006	2" SDR11 x 1 1/4" SDR11
2891008	2" SDR11 x 1 1/2" SDR11

CTS X IPS

Always Match Pipe Size & SDR



W-R	CTS X IPS REDUCERS
2890040	1/2" CTS x 3/4" SDR11
2890042	1/2" CTS x 1" SDR11

2890002	1" CTS x 3/4" SDR11
2890004	1" CTS x 1" SDR11



Con-Stab ID Seal® Fittings have been sold in the gas, plumbing, and propane markets since 1990. **Con-Stab®** fittings are IAPMO, CSA, & ICC approved.

CON-STAB® REDUCING TEES



Always Match **Pipe Size & SDR**



W-R	RUN	BRANCH
2883070	1" SDR11 x 3/4"	SDR11
2883061	1 1/4" SDR10 x 3/4"	SDR11
2883063	1 1/4" SDR10 x 1"	SDR11
2883062	1 1/4" SDR11 x 3/4"	SDR11
2883064	1 1/4" SDR11 x 1"	SDR11
2883080	1 1/2" SDR11 x 3/4"	SDR11
2883082	1 1/2" SDR11 x 1"	SDR11
2883083	1 1/2" SDR11 x 1 1/4"	SDR10
2883084	1 1/2" SDR11 x 1 1/4"	SDR11
2883050	2" SDR11 x 3/4"	SDR11
2883052	2" SDR11 x 1"	SDR11
2883053	2" SDR11 x 1 1/4"	SDR10
2883054	2" SDR11 x 1 1/4"	SDR11
2883056	2" SDR11 x 1 1/2"	SDR11

CON-STAB® SADDLE PUNCH TEES



Always Match **Pipe Size & SDR**



W-R	MAIN	OUTLET
2893090	1 1/4"	3/4" SDR-11
2893092	1 1/4"	1" SDR-11
2896002	1 1/2"	3/4" SDR-11
2896006	1 1/2"	1" SDR-11
2894002	2"	3/4" SDR-11
2894004	2"	1" SDR-11
2894006	2"	1 1/4" SDR-11
2894502	3"	3/4" SDR-11
2894504	3"	1" SDR-11
2894506	3"	1 1/4" SDR-11
2894508	3"	2" SDR-11



Con-Stab ID Seal® Fittings have been sold in the gas, plumbing, and propane markets since 1990. **Con-Stab®** fittings are IAPMO, CSA, & ICC approved.



CON-STAB® END CAPS

Always Match Pipe Size & SDR



W-R	Size	Wall (CTS) or SDR
2892000	1/2" CTS	.090
2892002	3/4" IPS	SDR-11
2892004	1" IPS	SDR-11
2892006	1 1/4" IPS	SDR-10
2892007	1 1/4" IPS	SDR-11
2892008	1 1/2" IPS	SDR-11
2892010	2" IPS	SDR-11

CONFLEX® FLEX RISERS FOR PROPANE



Continental "Con-Flex®" risers are flexible casings that protect **yellow polyethylene pipe** aboveground. **Con-flex®** risers consist of corrugated stainless steel flex hose, with a durable UV & weather-resistant outer sleeve. Conforms to NFPA 54 & 58 for LPG systems.

W-R	Description	SDR/Wall	Length
2887002	1/2" CTS	.090	36"
2887004	1/2" CTS	.090	84"
2887070	1" CTS	.099/.101	36"
2887020	3/4" IPS	SDR-11	36"
2887030	1" IPS	SDR-11	36"
2887040	1 1/4" IPS	SDR-10	36"
2887042	1 1/4" IPS	SDR-11	36"
2887050	1 1/2" IPS	SDR-11	36"
2887060	2"	SDR-11	36"



Instructions:

1. Disassemble the **adapter coupling** (B).
2. Feed the polyethylene pipe through the sleeve from the **moisture seal** (A) to the **adapter coupling** (B)
3. Assemble the **adapter coupling** by sliding the gasket over the tubing, and then pushing the tubing onto the insert. Tighten the compression nut until it bottoms out.



POLYETHYLENE GAS BALL VALVES

Always Match Pipe Size & SDR



W-R	Size	Wall (CTS) or SDR
2893102	3/4"	IPS SDR-11
2893104	1"	IPS SDR-11
2893106	1 1/4"	IPS SDR-11
2893108	1 1/2"	IPS SDR-11
2893110	2"	IPS SDR-11

Step 1: Match Pipe & SDR

BE SURE TO MATCH PIPE SIZE & SDR*

Pipe, Fittings, and Chamfer Tool must be the same!

*“SDR” stands for “Standard Dimension Ratio”. It is a designation of a pipe’s pressure rating. SDR is the ratio of Pipe Diameter to Wall Thickness.

Step 2: Chamfer Inside of Pipe

BEFORE **AFTER**

SQUARE-CUT **CHAMFER INSIDE** CHAMFERED

Follow the arrows printed on the label. Only 3-5 turns necessary for a good chamfer!

The “coupon” is the piece of yellow poly that is shaved off during the act of chamfering.

Test your chamfer by pushing the pipe over the test gauge. If the pipe is chamfered properly, it should fit over the test gauge with minimum effort.

Test Gauge

Step 3: Mark Stab Depth

MARK THE STAB DEPTH!

1. Line up the end of the yellow pipe with the hub of the fitting.

2. Mark a line on the pipe to approximate the end of the fitting.

3. **Goal:** The reason to mark the stab depth is to ensure that the pipe is sealed by **both** o-rings!

Step 4: Stab & Check

STAB PIPE INTO FITTING

Stab the pipe completely into the fitting, so that the “stab marker” is within 1/8” from the entrance of the fitting.

Once the pipe has been stabbed, it **cannot** be removed.

LOOK FOR THE “C”

You must use a **Continental Chamfer Tool** on a **Continental Fitting!**



**YELLOW PLASTIC
GAS PIPE**

**YELLOW "MEDIUM DENSITY"
(PE2406) PE GAS PIPE**



**NEW! 50 FOOT
CONVENIENCE COILS**

Conforms to ASTM D-2513



**Always
Match
Pipe Size
& SDR**

For several years, the gas utility and distribution market has used plastic gas pipe for its **ease-of-use, corrosion resistance, and cost effectiveness**. *NFPA 54* provides for the use of plastic piping within it's code for **outdoor, underground use only** at a **minimum burial depth of 18"**, using **yellow 14g tracer wire** for location purposes.



Call us today for:

- Free promotional materials
- One-on-One sales training
- Sizing/Technical assistance

W-R	Size	Wall (CTS) or SDR	Length
2880002	1/2" CTS	.090	150'
2880004	1/2" CTS	.090	500'
2880009	1/2" IPS	SDR-9.3	150'
2880011	3/4" IPS	SDR-11	50'
2880012	3/4" IPS	SDR-11	150'
2880016	3/4" IPS	SDR-11	500'
2880020	1" CTS	.099/.101	150'
2880021	1" CTS	.099/.101	500'
2880025	1" IPS	SDR-11	50'
2880022	1" IPS	SDR-11	150'
2880026	1" IPS	SDR-11	500'
2880029	1 1/4" IPS	SDR-10	50'
2880030	1 1/4" IPS	SDR-10	150'
2880031	1 1/4" IPS	SDR-11	50'
2880032	1 1/4" IPS	SDR-11	150'
2880036	1 1/4" IPS	SDR-11	500'
2880041	1 1/2" IPS	SDR-11	50'
2880042	1 1/2" IPS	SDR-11	150'
2880046	1 1/2" IPS	SDR-11	500'
2880051	2" IPS	SDR-11	50'
2880052	2" IPS	SDR-11	100'
2880056	2" IPS	SDR-11	500'
2880062	3" IPS	SDR-11.5	100'

LOW PRESSURE < 2PSI

HIGH PRESSURE = 2PSI

Pressure Drop: .5 in w.c. Spec. Gravity: .60						
Length (feet)	1/2 IPS SDR-9.3	3/4 IPS SDR-11	1 IPS SDR-11	1 1/4 IPS SDR-10	1 1/2 IPS SDR-11	2 IPS SDR-11
10	201	403	726	1260	1900	3410
20	138	277	499	865	1310	2350
30	111	222	401	695	1050	1880
40	95	190	343	594	898	1610
50	84	169	304	527	796	1430
60	76	153	276	477	721	1300
70	70	140	254	439	663	1190
80	65	131	236	409	617	1110
90	61	123	221	383	579	1040
100	58	116	209	362	547	983
125	51	103	185	321	485	871
150	46	93	168	291	439	789
175	43	86	154	268	404	726
200	40	80	144	249	376	675
250	35	71	127	221	333	598
300	32	64	115	200	302	542
350	29	59	106	184	278	499
400	27	55	99	171	258	464
450	26	51	93	160	242	435
500	24	48	88	152	229	411

Pressure Drop: 1.0 in w.c. Spec. Gravity: .60						
Length (feet)	1/2 IPS SDR-9.3	3/4 IPS SDR-11	1 IPS SDR-11	1 1/4 IPS SDR-10	1 1/2 IPS SDR-11	2 IPS SDR-11
10	1860	3720	6710	11600	17600	31600
20	1280	2560	4610	7990	12100	21700
30	1030	2050	3710	6420	9690	17400
40	878	1760	3170	5490	8300	14900
50	778	1560	2810	4870	7350	13200
60	705	1410	2550	4410	6660	12000
70	649	1300	2340	4060	6130	11000
80	603	1210	2180	3780	5700	10200
90	566	1130	2050	3540	5350	9610
100	535	1070	1930	3350	5050	9080
125	474	949	1710	2970	4480	8050
150	429	860	1550	2690	4060	7290
175	395	791	1430	2470	3730	6710
200	368	736	1330	2300	3470	6240
250	326	652	1180	2040	3080	5530
300	295	591	1070	1850	2790	5010
350	272	544	981	1700	2570	4610
400	253	506	913	1580	2390	4290
450	237	475	856	1480	2240	4020
500	224	448	809	1400	2120	3800

NATURAL GAS

LOW PRESSURE: 11 IN. W.C.

HIGH PRESSURE = 2PSI

Pressure Drop: .5 in w.c. Spec. Gravity: 1.50						
Length (feet)	1/2 IPS SDR-9.3	3/4 IPS SDR-11	1 IPS SDR-11	1 1/4 IPS SDR-10	1 1/2 IPS SDR-11	2 IPS SDR-11
10	340	680	1230	2130	3210	5770
20	233	468	844	1460	2210	3970
30	187	375	677	1170	1770	3180
40	160	321	580	1000	1520	2730
50	142	285	514	890	1340	2420
60	129	258	466	807	1220	2190
70	119	237	428	742	1120	2010
80	110	221	398	690	1040	1870
90	103	207	374	648	978	1760
100	98	196	353	612	924	1660
125	87	173	313	542	819	1470
150	78	157	284	491	742	1330
175	72	145	261	452	683	1230
200	67	135	243	420	635	1140
250	60	119	215	373	563	1010
300	54	108	195	338	510	916
350	50	99	179	311	469	843
400	46	92	167	289	436	784
450	43	87	157	271	409	736
500	41	82	148	256	387	695

Pressure Drop: 1.0 in w.c. Spec. Gravity: 1.50						
Length (feet)	1/2 IPS SDR-9.3	3/4 IPS SDR-11	1 IPS SDR-11	1 1/4 IPS SDR-10	1 1/2 IPS SDR-11	2 IPS SDR-11
10	3130	6260	11300	19600	29500	53100
20	2150	4300	7760	13400	20300	36500
30	1730	3450	6230	10800	16300	29300
40	1480	2960	5330	9240	14000	25100
50	1310	2620	4730	8190	12400	22200
60	1190	2370	4280	7420	11200	20100
70	1090	2180	3940	6830	10300	18500
80	1010	2030	3670	6350	9590	17200
90	952	1910	3440	5960	9000	16200
100	899	1800	3250	5630	8500	15300
125	797	1600	2880	4990	7530	13500
150	722	1450	2610	4520	6830	12300
175	664	1330	2400	4160	6280	11300
200	618	1240	2230	3870	5840	10500
250	548	1100	1980	3430	5180	9300
300	496	994	1790	3110	4690	8430
350	457	914	1650	2860	4320	7760
400	425	851	1530	2660	4020	7220
450	399	798	1440	2500	3770	6770
500	377	754	1360	2360	3560	6390

PROPANE

* Values listed are in cubic feet/meter (cfm). To calculate BTU, multiply by 1000.

** Source: NFPA 54-2012 Table 6.2 (s)

* Values listed are in cubic feet/meter (cfm). To calculate BTU, multiply by 1000.

** Source: NFPA 54-2012 Table 6.2 (s)

*Reproduced with permission from NFPA 54, *National Fuel Gas Code*, Copyright 2012. This reprinted material is not the complete and official position of the NFPA on the referenced subject, which is represented only by the standard in its entirety. Please consult your NFPA 54/ICC Fuel Gas codebook and appliance's technical literature for more detailed sizing and installation instructions.

FIRST-STAGE TO SECOND STAGE

Pressure Drop: 1.0 in w.c.		Spec. Gravity: 1.50				
Length (feet)	1/2 IPS SDR-9.3	3/4 IPS SDR-11	1 IPS SDR-11	1 1/4 IPS SDR-10	1 1/2 IPS SDR-11	2 IPS SDR-11
30	2143	4292	7744	13416	20260	36402
40	1835	3673	6628	11482	17340	31155
50	1626	3256	5874	10176	15368	27612
60	1473	2950	5322	9220	13924	25019
70	1355	2714	4896	8483	12810	23017
80	1261	2525	4555	7891	11918	21413
90	1183	2369	4274	7404	11182	20091
100	1117	2238	4037	6994	10562	18978
125	990	1983	3578	6199	9361	16820
150	897	1797	3242	5616	8482	15240
175	826	1653	2983	5167	7803	14020
200	778	1539	2775	4807	7259	13043
250	681	1363	2459	4260	6434	11560
300	617	1235	2228	3860	5830	10474
350	567	1136	2050	3551	5363	9636
400	528	1057	1907	3304	4989	8965
450	495	992	1789	3100	4681	8411
500	468	937	1690	2928	4422	7945

PROPANE

* Capacities listed are based on a pressure of 10 psig first stage setting and 1 psi pressure drop.

* Values listed are in cubic feet/meter (cfm). To calculate BTU, multiply by 1000.

** Source: NFPA 58-2012 Table 15.1 (s)

*Reproduced with permission from NFPA 54, *National Fuel Gas Code*, Copyright 2012. This reprinted material is not the complete and official position of the NFPA on the referenced subject, which is represented only by the standard in its entirety. Please consult your NFPA 54/ICC Fuel Gas codebook and appliance's technical literature for more detailed sizing and installation instructions.



YELLOW TRACER WIRE

W-R# Description

- 1842500** 500' Yellow Tracer Wire-14g
- 1842502** 500' Yellow Tracer Wire-18g

- Use tracer wire in the trench along yellow polypipe for an effective, code-compliant installation.



YELLOW BURIAL TAPE

W-R# Description

- 2426050** 3" x 1000' Non-Detectable
- 2426052** 3" x 1000' *Detectable*

- Burial Tape is used 6 -8" above the pipe and tracer wire in the trench.

GAS ACCESSORIES



**OMNI II
RF MARKING BALL**



W-R#	Description
------	-------------

2763002	Yellow RF Marking Ball
----------------	------------------------

- Required by select utilities for radiodetection purposes
- Reliable, battery-free design



MARKING STAKES

W-R#	Description	Min	Bag
------	-------------	-----	-----

2426102	Yellow	12	12
----------------	--------	----	----

- For additional colors, see page 231



**“NATURAL GAS”
ADHESIVE LABELS**



W-R#	Description	Min
------	-------------	-----

2425050	Small (3/4" x 1 1/4")	12
2425052	Medium (1 1/2" x 2 3/8")	12
2425054	Large (2 1/2" x 7 7/8")	12

2425072	Small (100 per roll)	1
2425074	Medium (100 per roll)	1



**DRIVE-IN MAGNESIUM
SPIKE ANODES**

W-R#	Description
------	-------------

2762001	1# w/lead wire & clamp
----------------	------------------------

- 3' of #12 TW wire



**ADJUSTABLE
UNIVERSAL BRACKET
FOR ANODELESS
RISERS**

W-R#	Description
------	-------------

2867050	3/4" to 2" Riser Bracket
2867062	3" to 4" Large Riser Bracket

- Adjustable from 6" - 10" from wall



**U-SHAPED BRACKET
FOR RISER**



W-R#	Description
------	-------------

2867002	U-Shaped Bracket
----------------	------------------

- 4" standoff from wall

COMPRESSION SERVICE FITTINGS



STEEL COMPRESSION RISERS

Know the Code:
Coated Steel Products
Require Additional
Cathodic Protection!

W-R	Description	SDR
2930002	3/4" IPS	SDR-11
2930004	1" IPS	SDR-11
2930006	1 1/4" IPS	SDR-10
2930008	1 1/2" IPS	SDR-11
2930010	2" IPS	SDR-11

- Fusion-bonded epoxy coating
- 10 psi
- Requires anode bag (not included)



STEEL COMPRESSION COUPLINGS

Know the Code:
Coated Steel Products
Require Additional
Cathodic Protection!

W-R	Description	SDR
2931002	3/4" IPS	SDR-11
2931004	1" IPS	SDR-11
2931006	1 1/4" IPS	SDR-10
2931008	1 1/2" IPS	SDR-11
2931010	2" IPS	SDR-11

- Fusion-bonded epoxy coating
- 10 psi
- Requires anode bag (not included)



STEEL COMPRESSION MALE ADAPTERS

Know the Code:
Coated Steel Products
Require Additional
Cathodic Protection!

W-R	Description	SDR
2935002	3/4" IPS	SDR-11
2935004	1" IPS	SDR-11
2935006	1 1/4" IPS	SDR-10
2935008	1 1/2" IPS	SDR-11
2935010	2" IPS	SDR-11

- Fusion-bonded epoxy coating
- 10 psi
- Requires anode bag (not included)



18"

EXTRA-LONG MALE ADAPTERS

W-R	Description	SDR
2935102	3/4" IPS	SDR-11
2935104	1" IPS	SDR-11



STEEL COMPRESSION TEES

Know the Code:
Coated Steel Products
Require Additional
Cathodic Protection!

W-R	Description	SDR
2933002	3/4" IPS	SDR-11
2933004	1" IPS	SDR-11
2933006	1 1/4" IPS	SDR-10

- Fusion-bonded epoxy coating
- 10 psi
- Requires anode bag (not included)



**INNERLYNX®
MECHANICAL SEALS**

**INNERLYNX® MECHANICAL SEALS
FOR WALL PENETRATIONS**



Specifications
 - Type: Standard "Model C"
 - EPDM Gaskets
 - Temp. Range: 40-250° F
 - Carbon Steel Bolts & Nuts

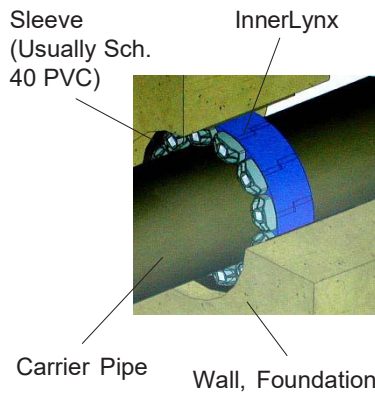

InnerLynx® mechanical seals are made of EPDM rubber, and are suitable for aboveground and direct burial applications. Innerlynx® form a strong hydrostatic seal, and electrically isolate the carrier pipe from the wall sleeve. Made in USA.

W-R#	Description	SKU
A000860	IL-200	priced per link
A000884	IL-265	priced per link
A000862	IL-275	priced per link
A000864	IL-300	priced per link
A000866	IL-315	priced per link
A000868	IL-325	priced per link
A000870	IL-340	priced per link
A000874	IL-400	priced per link
A000875	IL-410	priced per link
A000878	IL-425	priced per link
A000879	IL-475	priced per link

- Innerlynx® mechanical seals are ordered in belts of 10.



**ROYSTON LABS
"THICK 'N QUICK"®
MASTIC**

W-R#	Description	Min
1004002	"Thick 'N Quick"	1 gallon

- For protection of steel pipe in direct burial applications.



**POLYKEN® 826
YELLOW 12 MIL
PIPE WRAP TAPE**



W-R#	Description	Thickness	Min
1004020	2" X 100'	12 mil	1
1004030	4" X 100'	12 mil	1

- Interior and exterior pipe wrapping for corrosion and mechanical protection of small diameter pipe.



**UPC-APPROVED
PIPE WRAP TAPE**

W-R#	Description	Thickness	Min
1003002	2" X 100'	10 mil	1
1003004	2" X 100'	20 mil	1

- For protection of steel pipe in direct burial applications. Self-adhesive. UPC approved.



GAS APPLIANCE CONNECTORS



for: **Generators**



for: **Gas Grills**



3/8" QUICK-CONNECT HOSES

W-R#	Size
2862002	10 foot
2862004	12 foot

- 3/8" Female Flare x 3/8" Male Quick-Connect



3/4" GENERATOR HOSES

W-R#	Size
2866002	3/4" x 12"
2866006	3/4" x 24"
2866008	3/4" x 36"

- 3/4" Male (Swivel) x 3/4" Male (Swivel)



QUICK-CONNECT SHUTOFF VALVES

W-R#	Type	Inlet	Quick Connect
2861002	Straight	3/8" FIP	3/8" F
2861004	Angle	1/2" FIP	3/8" F



Female Quick Connect

QUICK-CONNECT FITTINGS

FEMALE

W-R#	FIP Size	Quick-Connection
2864002	3/8" FIP	3/8" QC Female
2864020	1/2" FIP	1/2" QC Female
2864022	3/4" FIP	3/4" QC Female



Male Quick Connect

MALE

W-R#	FIP Size	Quick-Connection
2864004	3/8" FIP	3/8" QC Male
2864040	1/2" FIP	1/2" QC Male
2864042	3/4" FIP	3/4" QC Male



2864006

ADAPTERS

W-R#	FIP Size	Quick-Connection
2864006	1/2" M Flare	3/8" QC Male
2864008	1/2" FIP	3/8" QC Male



STAINLESS STEEL GAS OUTLET BOXES

W-R#	Color
2863004	Stainless Steel



- 1/2" FIP Angle x 3/8" Female Quick-Connect

**GAUGES &
INSTRUMENTATION**



**W-R STANDARD
PRESSURE GAUGES**

- 1/4" NPT brass lower connection
- Black steel case
- For water, oil, & gas
- Not for use on oxygen

W-R#	Size	PSI	Increments
1712002	2"	15 psi	1/2 lb.
1712004	2"	30 psi	1/2 lb.
1712006	2"	60 psi	1 lb.
1712008	2"	100 psi	2 lb.
1712010	2"	160 psi	5 lb.
1712012	2"	200 psi	4 lb.
1712014	2"	300 psi	5 lb.
1712016	2"	400 psi	8 lb.
<hr/>			
1712502	2 1/2"	15 psi	1/2 lb.
1712504	2 1/2"	30 psi	1/2 lb.
1712506	2 1/2"	60 psi	1 lb.
1712508	2 1/2"	100 psi	2 lb.
1712510	2 1/2"	160 psi	5 lb.
1712512	2 1/2"	200 psi	4 lb.
1712514	2 1/2"	300 psi	5 lb.
1712516	2 1/2"	400 psi	8 lb.
<hr/>			
1712802	3 1/2"	15 psi	1/2 lb.
1712804	3 1/2"	30 psi	1/2 lb.
1712806	3 1/2"	60 psi	1 lb.
1712808	3 1/2"	100 psi	2 lb.
1712810	3 1/2"	160 psi	5 lb.
1712812	3 1/2"	200 psi	4 lb.
1712814	3 1/2"	300 psi	5 lb.
1712816	3 1/2"	400 psi	8 lb.
1712818	3 1/2"	600 psi	10 lb.
<hr/>			
1713002	4 1/2"	15 psi	1/2 lb.
1713004	4 1/2"	30 psi	1/2 lb.
1713006	4 1/2"	60 psi	1 lb.
1713008	4 1/2"	100 psi	2 lb.
1713010	4 1/2"	160 psi	5 lb.
1713012	4 1/2"	200 psi	4 lb.
1713014	4 1/2"	300 psi	5 lb.
1713016	4 1/2"	400 psi	8 lb.
1713018	4 1/2"	600 psi	10 lb.



**W-R STANDARD
PRESSURE GAUGES
WITH 1/8" LOWER NPT**

W-R#	Size	PSI	Increments
1717004	2 1/2"	100 psi	2 lb.

GAUGES & INSTRUMENTATION



VACUUM GAUGE

W-R#	Description	PSI
1720002	2" Vacuum	-30 psi
1720004	2½" Vacuum	-30 psi
1720006	3½" Vacuum	-30 psi

- ¼" NPT Lower Connection



COMPOUND GAUGE

W-R#	Description	PSI
1719002	2" Compound	30-0-30
1719004	2½" Compound	30-0-30
1719006	3½" Compound	30-0-30

- ¼" NPT Bottom Outlet



**1/4" NPT
BACK OUTLET
PRESSURE GAUGE**

W-R#	Description	PSI
1714002	2½" C.B.O.	30 psi
1714004	2½" C.B.O.	100 psi
1714202	3½" C.B.O.	30 psi



with red indicator arm

**WATER TEST GAUGE
WITH 3/4" FHT**



W-R#	Description	PSI
1721002	2½"	200 psi
1721010	2½" w/indicator	300 psi

- ¾" Female Garden Hose thread



**2 1/2" SILICON
LIQUID-FILLED GAUGE**

Stainless Steel Case
1/4" NPT Lower Connection

W-R#	Description	PSI
1712601	2 1/2"	30 psi
1712602	2 1/2"	60 psi
1712604	2 1/2"	100 psi
1712606	2 1/2"	200 psi
1712608	2 1/2"	300 psi

1720000 - 30 psi Vacuum

GAUGES & INSTRUMENTATION



STANDARD GAS TEST ASSEMBLY

W-R#	Description	Increments
1838103	2" 15# gauge	1/2 lb.
1838104	2" 30# gauge	1/2 lb.
1838106	2" 60# gauge	1 lb.
1838108	2" 100# gauge	2 lb.

- 3/4" FIP brass-plated manifold
- Fully sealed & assembled
- 1/8" air valve included



GAS TEST MANIFOLD & AIR VALVE

W-R#	Description	Min	Box
A000334	Manifold Only	1	-
1838102	1/8" Air Valve	12	12
1838150	1/4" Air Valve	12	12
1838100	Manifold & 1/8" Air Valve	1	-



BRASS M X F MINI-BALL ISOLATION VALVE

W-R#	Description	Min	Box
1707002	1/8" M x F	1	12
1707004	1/4" M x F	1	12



- 125 psi
- 180°F max temp



5 PSI & 10 PSI DIAPHRAGM GAUGE FOR GAS TEST

W-R#	Description	PSI
1715500	2 1/2" Diaphragm	5 psi
1715502	2 1/2" Diaphragm	10 psi

- 1/4" NPT
- 1/10 Increments
- Accuracy: 1.5% of full scale range



Please note: This gauge is extremely sensitive. Overpressurizing this gauge will cause the measuring element to fail and render the gauge inoperable. Wal-Rich will not accept returns of gauges that are improperly used.

GAUGES & INSTRUMENTATION

**DIAPHRAGM
LOW-PRESSURE GAS
TEST ASSEMBLY**



W-R#	Description	Min	Box
------	-------------	-----	-----

1838110	5 psi Low Pressure Test Kit		
1838112	10 psi Low Pressure Test Kit		

- Furnished as shown with hexagonal test block, 1/8" tank valve, & 1/8" Male X Female Air Cock.

- Uses 2 1/2" 1/4" NPT Diaphragm Gauge
- **Increments: 1/10 psi**
- Accuracy: 1.5% of full-scale range

Please note: This gauge is extremely sensitive. Overpressurizing this gauge will cause the measuring element to fail and render the gauge inoperable. Wal-Rich will not accept returns of gauges that are improperly used.

**DIAPHRAGM
LOW-PRESSURE
GAS TEST KIT WITH
RUBBER BULB**



W-R#	Description
------	-------------

GT-5	5 PSI Kit
GT-10	10 PSI Kit
1838200	Bulb & Tubing Only

- Furnished as shown with hexagonal test block, 1/8" tank valve, & 1/8" Male X Female Air Cock.

- **Increments: 1/10 psi**
- Accuracy: 1.5% of full-scale range

Please note: This gauge is extremely sensitive. Overpressurizing this gauge will cause the measuring element to fail and render the gauge inoperable. Wal-Rich will not accept returns of gauges that are improperly used.

**DIAPHRAGM
LOW-PRESSURE
GAS TEST KIT WITH
DOUBLE-TAPPED
MANIFOLD**



W-R#	Description
------	-------------

BDGT-5	5 PSI "NYC" Kit
BDGT-10	10 PSI "NYC" Kit

Contains:

- Steel Double-tapped hexagonal test block
- 1/4" Male x Female Air Cock
- 1/8" Male x Female Air Cock
- 2 1/2" 15 psi Standard Pressure Gauge
- **Uses 2 1/2" 1/4" NPT 5# or 10# Diaphragm Gauge**
- (Increments: 1/10 psi for minute readings)**
- Accuracy: 1.5% of full-scale range

Please note: This gauge is extremely sensitive. Overpressurizing this gauge will cause the measuring element to fail and render the gauge inoperable. Wal-Rich will not accept returns of gauges that are improperly used.

GAUGES & INSTRUMENTATION



HOT WATER DIAL THERMOMETER

W-R# Description

- 1722011** Angle (Back Outlet)
- 1722013** Straight (Bottom Outlet)

SIZE: 3½" Face, ½" NPT
 CASE: Steel
 WINDOW: Glass
 SOCKET: Brass
 RANGE: 40° TO 240°



"SNAP-WELL" THERMOMETERS

W-R# Description

- * **1722014** 2" w/Brass Probe
- 1722015** 2" w/Aluminum Probe
- 1722016** 2" w/¾" Sweat Well
- 1722017** 2" Deluxe w/IPS & Sweat Wells



- 1722060** 3 1/4" w/Brass Probe

- 1722050** 1/2" IPS well only
- 1722052** 3/4" SWT well only

- ½" NPT connection
 - Graduation from 40° to 240°



W-R BRASS WELL THERMOMETER

W-R# Description

- 1722000** Straight (Bottom Mount)
- 1722001** Angle (Back Mount)

- 6" Non-corrosive Valox® case
 - ½" NPT connection
 - Graduation from 40° to 280°



ECONOMY HOT WATER THERMOMETERS

W-R# Description

- 1722002** Steel Well - Straight
- 1722004** Steel Well - Angle
- 1722006** Brass Well - Straight
- 1722008** Brass Well - Angle

- 6" steel case case with white lacquer finish
 - ½" NPT connection
 - Graduation from 40° to 280°

GAUGES & INSTRUMENTATION

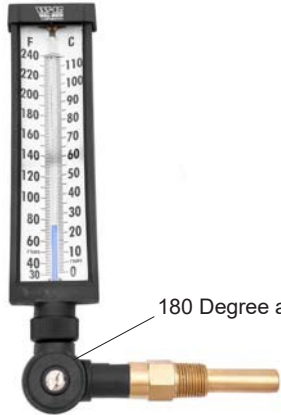

180 Degree adjustment

ADJUSTABLE ANGLE THERMOMETER

W-R#	Description
------	-------------

1722020 7" for Hot Water

1722025 9" for Hot Water

- Adjustable radius of 180 Degrees
- 1/2" Brass Connection
- 40-240° F



POCKET THERMOMETERS

W-R#	Description
------	-------------

1802214 0 - 220°F



STRAP-ON THERMOMETER

W-R#	Description
------	-------------

1722030 2 1/2" 40-240°F

- Fits 3/4" - 1 1/2" Copper Tube



DIGITAL POCKET THERMOMETERS

W-R#	Description	Min.	Box
------	-------------	------	-----

1802216 -40° - 300°F 1 6

- Battery included



W-R TRIDICATOR



1711016 (1" shank)



1711018 & 1711019 (2 1/4" long shank)

W-R#	Face	PSI	NPT	Outlet
------	------	-----	-----	--------

1711016 2 1/2" (75 psi) 1/4" Angle

1711018 2 1/2" (75 psi) 1/4" Angle

1711019 2 1/2" (200 psi) 1/4" Angle

- 60° - 320°F

W-R#	Face	NPT	Outlet
------	------	-----	--------

1711015 3 1/4" 1/4" Straight

1711011 3 1/4" 1/2" Angle

1711009 3 1/4" 1/2" Straight

- 70° - 250°F
- 0 - 55 psi

**GAUGES &
INSTRUMENTATION**



**MARSHALLTOWN®
TRIDICATOR
SQUARE FACE**



W-R#	Face	NPT	Outlet
1711010	3 1/2"	1/2"	Angle
1711012	3 1/2"	1/2"	Straight

- Made in USA
- 60°-260°F
- 0 - 60 psi



**THERMOWELL FOR
AQUASTAT**

W-R#	Diameter	Length
1751032	1/2"	3"
1751034	3/4"	3"
1751038	3/4"	6"

- Brass immersion well
- Fits Honeywell, White Rodgers



PRESSURE SNUBBER

W-R#	Description
1726004	1/4" Brass Snubber

- 1000 psi
- 10 micron
- For regulation of sudden pressure changes



**PIGTAIL STEAM
SYPHON**

1/4"MNPT x 1/4"MNPT

W-R#	Description	Box
1706002	Straight (180°) - Steel	6
1706006	Straight (180°) - Brass	6
1706004	Angle (90°) - Steel	6
1706008	Angle (90°) - Brass	6



**PRESSURE/
TEMPERATURE
TEST PLUG**

W-R#	Description
1726020	1/4" Brass P/T Plug
1726022	1/4" Gauge Adapter

- Max Temp: 350°F
- Max Pressure: 1000 psi
- Nordel Core for hot/cold water applications



**PRESSURE GAUGE
NEEDLE VALVE**

W-R#	Description
1726010	1/4" Brass Needle Valve

- Max Temp: 300°F
- Max Pressure: 600 psi

STEAM SPECIALTIES



**ANGLE
STEAM
RADIATOR VALVES**

W-R#	Description	Min	Box
0408102	1/2"	1	10
0408104	3/4"	1	6
0408002	1"	1	4
0408004	1 1/4"	1	2
0408006	1 1/2"	1	2

- Brass



**STRAIGHT
STEAM
RADIATOR GATE
VALVES**

W-R#	Description	Min	Box
0409002	1"	1	4
0409004	1 1/4"	1	2

- Brass
- Imported



**ANGLE
HOT WATER
RADIATOR VALVES**

W-R#	Description	Min	Box
0409502	1/2"	1	4
0409504	3/4"	1	2

- Brass
- Imported



**THREE-LUG
RADIATOR HANDLE**

W-R#	Description	Min	Box
1705002	3 Lug	1	12

- Furnished with three lugs to fit practically all size radiator valves.
- Individually bagged



**THREE-SCREW
RADIATOR HANDLE**

W-R#	Description	Min	Box
1705004	3 Screw	1	12

- Three set screws hold spud securely to stem.
- Individually bagged



**4-IN-1
RADIATOR HANDLE**

W-R#	Description	Min	Box
1705006	Fitall Plate	1	12

- One plate fits four sizes of stems.
- Individually bagged

STEAM SPECIALTIES



**AUTOMATIC
HOT WATER - AIR VENT**

W-R#	Description	Min	Box
1700200	1/8"	1	12

- 30 psi
- 225° Farenheit



**COMBINATION
COIN / KEY AIR VALVE**

W-R#	Description	Min	Box
1701202	1/8" Valve Only	25	25
1701220	Valve & Key	25	25

- Nickel Plated



STUBBY AIR VALVE

W-R#	Description	Min	Box
1701204	1/8"	24	24

- Nickel Plated



AIR VALVE KEYS

W-R#	Description	Min	Box
1701208		25	25

- Nickel Plated



**CHROME-PLATED
CROWN "QUICK-VENT"**

W-R#	Description	Fig#	Orifice	Box
1700302	1/8" Angle	4AV	1.50mm	12
1700304	1/8" Angle	5AV	2.45mm	12
1700306	1/8" Angle	6AV	3.15mm	12
1700308	1/8" Angle	CAV	3.66mm	12
1700310	1/8" Angle	DAV	5.35mm	12

Features:

- Chrome-plated finish
- Brass valve stem assembly
- Imported



**CHROME-PLATED
RADIATOR AIR VENTS**

W-R#	Description	Box
1700102	1/8" Angle	12
1700108	1/8" Angle- Adjustable	12
1700104	1/8" Straight	12
1700106	1/4" Straight	12
1700110	3/4" X 1/2" Straight	12

STEAM SPECIALTIES



3 IN 1 RADIATOR REPAIR TOOL

W-R#	Description	Min	Box
1822002		1	12

• Extracts broken air valves, retaps radiator, rethreads air valves.



TAPPED CAPS

W-R#	Description	Min	Box
1743002	1 1/4" x 1/8"	1	12



W-R WATER GAUGE SET

W-R#	Description	Min	Box
1723002	1/2"	1	12

- 125 psi
- 5/8" x 12" standard gauge glass



1723200



2712006



2715002, 2715004

WATER GAUGE SET ACCESSORIES

W-R#	Description	Min	Box
1723200	5/8" Brass Nut	12	12
2712006	5/8" Friction Ring	25	100
2715004	5/8" Rubber Washer	50	50

2715002 5/8" Redline Washer 1 -

W-R#	Description	Min
------	-------------	-----

2715802 Nuts/Rings/Washers Kit 1
- Contains 1 pair of 1723200, 2712006, & 2715004

2715104 Rings/Washers (Pair) 1
- Contains 1 pair of 2712006 & 2715004



GAUGE GLASS



"RED-LINE" HIGH PRESSURE GAUGE GLASS

W-R#	Description	Min
1724002	5/8" x 8"	1 dz.
1724004	5/8" x 10"	1 dz.
1724006	5/8" x 12"	1 dz.
1724008	5/8" x 14"	1 dz.
1724012	5/8" x 18"	1 dz.
1724018	5/8" x 24"	1 dz.
1724022	5/8" x 36"	1 dz.

1724000 5/8" x 12" Redline 1pc.
1724001 5/8" x 24" Redline 1pc.

STEAM SPECIALTIES



GAUGE GLASS CUTTERS

W-R#	Description	Min	Box
1801000	Tong-Type	1	12

REPLACEMENT WHEEL AND PIN

1801004	Replacement - Wheel & Pin		6
---------	---------------------------	--	---



QUARTER-TURN GAUGE GLASS CUTTERS

W-R#	Description	Min	Box
1801006	Cutter	1	12



- Domestic



CHAIN-TYPE GAUGE GLASS CUTTERS

W-R#	Description	Min	Box
1801008	Cutter	1	12



- Domestic



E-Z FIX BOILER PLUGS



W-R#	Description	Min	Box
1709002	1 3/4" (12/card)	1 cd.	20 cds.
1709004	1 3/4" (Bulk)	12	144

- Toggle-style plug fits into hole in boiler jacket, then creates seal when tightened.



CAST IRON BOILER TUBE REPAIR PLUGS

W-R#	Description	Min	Box
1708002	1 1/2"	1	25
1708004	2"	1	25
1708006	2 1/2"	1	18
1708008	3"	1	18
1708010	3 1/2"	1	12



DIRT POCKET CAP FOR LOW-WATER CUTOFFS

W-R#	Description	Min	Box
1751012	3/4" Cap	1	12

- Cast iron
- With gasket & mounting bolts

1751011	Gasket Only		12
---------	-------------	--	----

STEAM TRAPS & SPECIALTIES



MEPCO™ ANGLE STEAM TRAPS

W-R#	Size	MEPCO#	Style
2750002	1/2"	1E-AP	Angle
2750004	3/4"	2E-AP	Angle



MEPCO™ STRAIGHT STEAM TRAPS

W-R#	Size	MEPCO#	Style
2755002	1/2"	1E-SW	Straight
2755004	3/4"	2E-SW	Straight



MEPCO™ THERMOSTATIC DISCS

W-R#	Size	MEPCO#	Style
2830102	1/2"	C5940	1E
2830104	3/4"	C5941	2E

- Low pressure radiator trap--good for 25" vacuum to 25 psi



BARNES & JONES™ ANGLE STEAM TRAPS

W-R#	Size	B/J#	Style
2751002	1/2"	122-A	Angle
2751004	3/4"	134-A	Angle



BARNES & JONES™ STRAIGHT STEAM TRAPS

W-R#	Size	B/J#	Style
2756002	1/2"	122-S	Straight
2756004	3/4"	134-S	Straight

**APOLLO®
HEATING SPECIALTIES**



**15 PSI RELIEF VALVE
FOR STEAM BOILERS
-STANDARD-**

"Apollo" Valves

W-R#	Size	Conbraco#	PSI	LBS/HR
1727001	3/4"	13-511-B15	15	407
1727000	3/4"	13-211-B15	15	475
1727002	1"	13-202-B15	15	643
1727004	1 1/4"	13-213-B15	15	1200
1727006	1 1/2"	13-214-B15	15	1900
1727008	2"	12-205-08	15	2500
1727010	2 1/2"	12-206-08	15	3529
1727012	3"	12-208-08	15	4100

**15 PSI RELIEF VALVE
FOR STEAM BOILERS
-HI-CAPACITY-**

W-R#	Size	Conbraco#	PSI	LBS/HR
1727606	2"	14-205-08	15	3150
1727608	2 1/2"	14-206-08	15	4676
1727610	3"	14-207-08	15	6843



"Apollo" Valves

**RELIEF VALVE FOR
HOT WATER BOILERS**



W-R#	Size	Conbraco#	PSI
1725008	3/4" F x F	10-408-05	30
1725006	3/4" M x F	10-407-05	30
1725009	3/4" M x F	10-417-09	45
1725010	3/4" M x F	10-417-10	50



"Apollo" Valves

**RELIEF VALVE FOR
WATER HEATERS**

W-R#	Size	Conbraco#	PSI
1725504	3/4" M x F	18C-402-30	150
1725510	3/4" M x F Long Shank	18C-402-X38	150

- 3" Element
- 105,000 BTU



"Apollo" Valves

**RELIEF VALVE FOR
TANKLESS WATER
HEATERS**

W-R#	Size	Conbraco#	PSI
1725602	3/4" M x F	17-402-04	150

- Pressure only
- 200,000 BTU



"Apollo" Valves

**PRESSURE ONLY
RELIEF VALVE**

W-R#	Size	Conbraco#	PSI
1725002	1/2" M x F	16-202-04	125

- Relieves excess pressure in water supply lines.

**APOLLO®
HEATING SPECIALTIES**



**DOUBLE FEMALE
AIRCOCK**

W-R#	Size	Conbraco#	Min	Box
1702002	1/8"	41-370-01	1	25
1702004	1/4"	41-380-01	1	25



MALE PETCOCK

W-R#	Size	Conbraco#	Min	Box
1703002	1/8"	41-060-01	1	25
1703004	1/4"	41-070-01	1	25



**MALE X FEMALE
AIRCOCK**

W-R#	Size	Conbraco#	Min	Box
1704002	1/8"	41-400-01	1	25
1704004	1/4"	41-410-01	1	25
1704005	3/8"	41-420-01	1	25

"Apollo" Valves



**STANDARD
ROUGH BRONZE
WATER GAUGE SETS**

W-R#	Size	Conbraco#
1723006	1/2"	20-104-00

- Service Rating: 125 psi @ 300°F, -300 psi @ 100°F
- Furnished with 5/8" x 10 standard glass
- Aluminum Wheel
- Features 1/4" Needle drain valve in lower arm.

"Apollo" Valves



**COMPRESSION GAUGE
COCK**

W-R#	Size	Conbraco#
1704204	1/2"	26-104-01

(TRICOCK)

- 125 psi
- Aluminum Wheel

"Apollo" Valves



**ANTI-SIPHON
VACUUM BREAKERS
- LEAD FREE -**

W-R#	Size	Finish	Conbraco#
4413002	1/2"	RB	38-LF-203-01
4413004	3/4"	RB	38-LF-204-01
4413006	1"	RB	38-LF-105-01

LEAD FREE

4413001	3/8"	Satin CP	38-LF-102-03
4413003	1/2"	Satin CP	38-LF-203-03
4413005	3/4"	Satin CP	38-LF-204-03

"Apollo" Valves

**HYDRONIC
HEATING SPECIALTIES**



**CAST BRASS
BASEBOARD TEE**

W-R#	Description
2103002	3/4" C x 3/4" C x 1/8" FIP

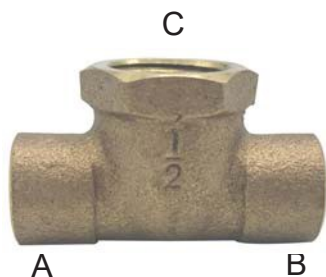

**CAST BRASS
ADAPTER TEE**

W-R#	A	B	C
2103052	1/2" C	x 1/2" C	x 1/2" FIP
2103050	3/4" C	x 3/4" C	x 1/2" FIP
2103054	3/4" C	x 3/4" C	x 3/4" FIP

LEAD FREE

4103052	1/2" C x 1/2" C x 1/2" FIP *LF*
4103050	3/4" C x 3/4" C x 1/2" FIP *LF*
4103054	3/4" C x 3/4" C x 3/4" FIP *LF*



**CAST BRASS
ADAPTER ELBOW
FEMALE**

W-R#	Description
2106002	1/2" C x 1/2" FIP Elbow



**CAST BRASS
DROP-EAR ELBOW
- LEAD FREE**

W-R#	Description	Min	Bag
4623002	1/2" C x 1/2" FIP Elbow *LF*		



4623010	1/2" PEX x 1/2" FIP Elbow *LF*
---------	--------------------------------



**CAST BRASS
REAMED ADAPTERS
- LEAD FREE**

W-R#	Description
4019302	1/2" C x 3/8" IPS Fem Ream
4019304	1/2" C x 1/2" IPS Fem Ream
4019306	1/2" C x 3/4" IPS Fem Ream
4019308	3/4" C x 1/2" IPS Fem Ream



- Reamed adapters allow transition from plain-end brass pipe to copper pipe.

HYDRONIC HEATING SPECIALTIES



BRONZE MONOFLOW TEES
- CTS X CTS

W-R#	Main	Branch
4107002	3/4" CTS	1/2 CTS Monoflow
4107004	1" CTS	1/2 CTS Monoflow
4107006	1" CTS	3/4 CTS Monoflow



- In hydronic systems, monoflow tees divert water from primary to secondary loop.



BRONZE MONOFLOW TEES
- PEX X PEX

W-R#	Main	Branch
4107030	3/4" PEX	1/2 PEX Monoflow



- In hydronic systems, monoflow tees divert water from primary to secondary loop.
- F1807 crimp PEX



BRONZE VENTURI "SCOOP" TEES
- CTS X CTS

W-R#	Main	Branch
4107020	3/4" CTS	1/2 CTS Scoop



- In hydronic systems, venturi tees divert water from primary to secondary loop.



DROP-EAR BALL VALVES
PEX X PEX

W-R#	Description
4402102	1/2" PEX with Drain
4402202	1/2" PEX without Drain



T-HANDLE BOILER DRAINS

W-R#	Description	Min	Box
0406010	1/2" Male	1	10
0406012	3/4" Male	1	5



LEAD FREE

4406010	1/2" Male-LF	1	10
4406012	3/4" Male-LF	1	5

**HYDRONIC
HEATING SPECIALTIES**



**CHROME-PLATED
BRASS QUARTER TURN
SILCOCKS**



W-R#	Description	Min	Box
0407002	1/2" FIP	1	10
0407004	3/4" FIP	1	10
0407052	1/2" CTS	1	10
0407054	3/4" CTS	1	10



**CHROME-PLATED
BRASS QUARTER TURN
SILCOCKS
- LEAD FREE**



W-R#	Description	Min	Box
4407002	1/2" FIP - LF	1	10
4407004	3/4" FIP - LF	1	10
4407052	1/2" CTS - LF	1	10
4407054	3/4" CTS - LF	1	10
4407072	1/2" PEX - LF	1	10



**EXPANSION TANK
ISOLATION VALVE
WITH DRAIN**



W-R#	Description	Min	Box
4417002	1/2" M X F	1	12



**SINGLE SHUTOFF
EXPANSION TANK
VALVE WITH DRAIN**



W-R#	Description	Min	Box
0408302	1/2" M X F Single Shutoff	1	12

- Isolates expansion tank and allows to fill the boiler at "0" pressure location, between expansion tank and air scoop.



**DOUBLE SHUTOFF
EXPANSION TANK
VALVE WITH DRAIN**



W-R#	Description	Min	Box
0408304	1/2" M X F Double Shutoff	1	12

- Isolates both expansion tank and fill valve.

BOILER & OIL BURNER SPECIALTIES



HONEYWELL® PILOT BURNER ASSEMBLY

W-R#	Honeywell#	Type	Min
1739002	Q314A-4586	Front	1
1739004	Q314A-6094	Left	1
1739006	Q314A-6102	Right	1

- for Natural Gas & LP (orifice included)



HONEYWELL® PILOT BURNER ASSEMBLY

W-R#	Honeywell#	Type	Min
1739010	Q327A-1626	Batwing	1

- for Natural Gas & LP (orifice included)



HONEYWELL® IGNITER-BURNER

W-R#	Honeywell#	Type	Min
1739202	Q345A-1305	FRONT	1

- for Natural Gas



HONEYWELL® THERMOPILE GENERATORS

W-R#	Honeywell#	Type	Min
1739302	Q313A-1139	750 mV	1

- for Natural Gas



COPPER THERMOCOUPLES

W-R#	Description	Min	Box
1743200	18"	1	10
1743202	24"	1	10
1743204	30"	1	10
1743206	36"	1	10
1743208	48"	1	10



ALUMINUM TUBING

W-R#	Description	Min	Box
0817002	1/8" X 50'	1	1
0817004	1/4" X 50'	1	1
0817006	3/8" X 50'	1	1
0817008	1/2" X 50'	1	1



-Soft aluminum tubing for pilot lines, etc.
- 50 foot coil

BOILER & OIL BURNER SPECIALTIES



PILOT TUBING KITS

W-R#	Description	Min	Box
0817502	1/8" x 36"	1	12
0817506	1/4" x 36"	1	12
0817508	1/4 x 1/8" x 36"	1	12
0817504	1/4" x 60"	1	12

- Includes tubing & 2 brass pilot fittings



BRASS PILOT NUTS

W-R#	Description	Min	Box
2130002	1/8"	12	12
2130004	1/4"	12	12
2130006	1/4" X 1/8"	12	12



**PVC
TERMINATION VENT
WITH 304SS SCREEN**

W-R#	Description	Min	Box
2202050	2"	1	10
2202052	3"	1	10
2202054	4"	1	10
2202056	6"	1	10



Patent# D715,409

2202060	1"	1	10
---------	----	---	----

- Prevent pests & leaves from entering vent piping
- Push into hub for easy flush installation.
- Patented condensate channel prevents buildup & freezing.
- Made in USA



**POLYPROPYLENE
TERMINATION VENT
WITH 304SS SCREEN**

W-R#	Description	Min	Box
2202070	2" (60mm)	1	10
2202072	3" (80mm)	1	10
2202074	4" (100mm)	1	10



- Fits popular polypropylene venting systems. Check manufacturer OD.



**GRAY SCH80 PVC
TERMINATION VENT
WITH 304SS SCREEN**

W-R#	Description	Min	Box
2202080	2"	1	10
2202082	3"	1	10
2202084	4"	1	10



BOILER & OIL BURNER SPECIALTIES

INTAKE AIR



VENT PIPE LABELS FOR DIRECT VENT APPLIANCES



W-R#	Description	Min
2425036	White "Intake Air"	100
2425038	Yellow "Intake Air"	100

- For compliance with local fuel gas codes.
- MA 248 CMR 12.7.6.1
- Vinyl self-adhesive label

EXHAUST



VENT PIPE LABELS FOR DIRECT VENT APPLIANCES



W-R#	Description	Min
2425044	White "Exhaust"	100
2425046	Yellow "Exhaust"	100

- For compliance with local fuel gas codes.
- MA 248 CMR 12.7.6.1
- Vinyl self-adhesive label



EXTERIOR COMPLIANCE SIGNAGE FOR DIRECT VENT APPLIANCES



W-R#	Description	Min
2425060	Yellow Sign "Gas Vent Below"	25

- For compliance with local fuel gas codes.
- MA 248 CMR 12.9.7

ADHESIVE PIPE MARKING LABELS

- DOMESTIC COLD WATER
- DOMESTIC HOT WATER
- CHILLED WATER SUPPLY
- CHILLED WATER RETURN
- HEATING HOT WATER SUPPLY
- HEATING HOT WATER RETURN
- CONDENSATE
- FIRE SPRINKLER WATER
- STEAM SUPPLY
- STEAM RETURN

	Color	Small	Medium	Large
Domestic Cold Water	Green	2425502	2425504	2425506
Domestic Hot Water	Yellow	2425511	2425513	2425515
Chilled Water Supply	Green	2425520	2425522	2425524
Chilled Water Return	Green	2425531	2425533	2425535
Heating Hot Water Supply	Yellow	2425540	2425542	2425544
Heating Hot Water Return	Yellow	2425561	2425563	2425565
Condensate	Yellow	2425570	2425572	2425574
Fire Sprinkler Water	Red	2425581	2425583	2425585
Steam Supply	Yellow	2425590	2425592	2425594
Steam Return	Yellow	2425601	2425603	2425605



- All sizes packed 10 per bag
- Small: Pipe sizes 3/4" to 1 1/4"
- Medium: Pipe sizes 1 1/2" to 2 1/4"
- Large: Pipe sizes 2 1/2" to 7 7/8"

OIL TANK SPECIALTIES



OIL FILTERS



W-R#	Description	Min	Box
1751014	Filter to Fit IA-25A		6

- UL rated: 15 GPH at 50 psi
- Aluminum alloy top with 3/8" connections
- Contains element



OIL FILTER ELEMENTS



W-R#	Description	Fits Models	Box
1751016	Gray Felt	IA-25A	12
1751022	White Micro-Flo	IA-25A	12
1751018	Gray Felt	2A-700A	

- Includes Gaskets & Washers
- 12 per bag



36" FLEXIBLE BRAIDED HEATING OIL LINES



W-R#	Description	Min
1964004	1/4" MIP x 1/4" MIP	1
1964008	3/8" Flare x 3/8" Flare	1

- For use as oil burner pump suction and return lines (not for nozzle line)
- For #1 & #2 heating oil



OIL TANK ELBOWS



W-R#	Description	Min
0402102	3/8" MIP X 1/2" MIP Sch40 Reducing Elbow	1



STRAIGHT FUSIBLE PLUG VALVES

W-R#	Description
0402002	3/8" FIP X FIP Straight



INNER-TITE CORP.



ANGLE FUSIBLE PLUG VALVES

W-R#	Description	Min
0402008	3/8" Flare X 1/4" MIP	1 1/2"
0402010	3/8" Flare X 1/4" MIP	3"

Inner-Tite Fusible Inline Valves are engineered to stop the flow of fuels in the event that the room temperature exceeds 165°F.

OIL TANK SPECIALTIES



DUPLEX TANK BUSHING WITH FITTINGS
SOLID PATTERN

W-R#	Description	Box
1744002	2" x 3/8" with fittings	12
1744004	2" x 1/2" with fittings	12

• 2" cast iron hexagon bushing with brass connectors. For slipping tubing through into oil tank.



TANK FITTINGS

2019502	3/8" x 3/8" fitting only	12
2019504	1/2" x 1/2" fitting only	12



MALLEABLE IRON RAILING FLANGES

BLACK	SIZE	Box
2511008	1/2"	25
2511010	3/4"	25
2511012	1"	25
2511014	1 1/4"	12
2511016	1 1/2"	12
2511018	2"	12



GALVANIZED STAMPED STEEL SLIP-ON VENT CAPS

W-R#	Description	Min	Box
1741010	1 1/4"	1	12
1741012	2"	1	12

- Furnished with screw & screen



GALVANIZED MALLEABLE IRON VENT CAPS

W-R#	Description	Min	Box
1741002	1 1/4" I.P.S.	1	12
1741004	2" I.P.S.	1	12

- Furnished with screen



HEAVY PATTERN OIL FILL BOX

W-R#	Description	Min	Box
1742002	2" I.P.S.	1	12
1742004	3" I.P.S.	1	12

- Galvanized Iron with Brass Plug

1742003	2" Brass plug only		
1742005	3" Brass plug only		

CIRCULATOR PUMP SPECIALTIES



CIRCULATOR FLANGE GASKETS



W-R#	Description	Min	Box
1751002	Pair/bag	1 pr.	50 pr.
A000337	Bulk	100	100

- 1 1/2" ID center, 1/2" ID screw holes
- 1/8" Red SBR rubber
- Fits B&G, Taco, and most other circulators



CIRCULATOR FLANGE REPAIR KIT



W-R#	Description	Box
1751004	Gasket/Nuts/Bolt Kit	6

- Package contains:
 - (4) 7/16" 14T bolts
 - (4) 7/16" hex nuts
 - (2) A000337 gaskets
- Fits B&G, Taco, and most popular circulators.
- Bagged



CIRCULATOR FLANGE NUTS AND BOLTS



W-R#	Description	Box
1751006	Nut/Bolt Kit	6

- Package contains:
 - (4) 7/16" 14T bolts
 - (4) 7/16" hex nuts



MALLEABLE IRON CIRCULATOR FLANGE KITS

W-R#	Description	Min	Box
1752002	3/4"	1 pr.	12
1752004	1"	1 pr.	12
1752006	1 1/4"	1 pr.	12

- Kit includes 2 flanges, 4 bolts and nuts
- Green color to match Taco



CIRCULATOR COUPLING FOR B&G

W-R#	Description	Ref#	Box
1751010	Coupling (118705)		12

- Cast Iron
- Shaft Diameters 1/2" x 1/2"



BRASS SPRING COUPLER FOR B & G

W-R#	Description	Min	Box
1751030	Fits B&G 100 booster pumps	1	12

- Shaft Diameters 1/2" x 1/2"

**WATER HEATER ELEMENTS
& THERMOSTATS**



**SCREW-IN
WATER HEATER
ELEMENTS**



W-R#	Length	Volts	Watts
1940002	7"	120V	1500W
1940007	12"	240V	3500W
1940008	12 7/8"	240V	4500W
1940010	12 7/8"	240V	5500W



**THERMOSTAT
CONTROLS FOR
WATER HEATER
ELEMENTS**



W-R#	Description	Min	Box
A. 1950002	Lower Control	1	12
B. 1950006	Upper Control with HLC	1	12



**UNIVERSAL ADAPTER
KITS WATER HEATER
ELEMENTS**

W-R#	Description	Min	Box
1951002		1	12

- Contains thermostat bracket, 4-bolt gasket, round gasket, and threaded Universal adapter.



**WATER HEATER
DRAIN VALVES**

W-R#	Description	Min
1945004	2 1/2" Brass	1



HEAT TRAP NIPPLES

W-R#	Description	Min	Box
0226020	Per Pair	1	12



**POLYPROPYLENE
WATER HEATER
RUNOFF TUBES**



W-R#	Description	Dimension	...
1963052	Straight	3/4" x 60"	
1963054	Angle	3/4" x 59" x 12"	

- Meets requirements of ASME A112.4.1-2009.
- Listed by IAPMO/UPC (File# C-4382)
- Zinc die cast nipple with polypropylene tube



FLARED PEX DIP TUBE

W-R#	Description	Min	Box
1963002		12	12

WATER HEATER & ELECTRICAL ACCESSORIES



CORRUGATED STAINLESS STEEL WATER CONNECTORS



W-R#	Description	Length
1960002	3/4" FIP x 3/4" FIP	12"
1960006	3/4" FIP x 3/4" FIP	18"
1960008	3/4" FIP x 3/4" FIP	24"

- For Residential Water Heaters, Tankless Heaters, Boilers, & Softeners



GROUNDING CLAMPS FOR WATER PIPE

W-R#	Description	Min	Box
2201002	1/2"-1" Clamp	1	12

- Bronze alloy



GROUNDING KIT FOR WATER HEATERS

W-R#	Description
2201050	Kit w/ 12" 6g copper wire
2201052	Kit w/ 24" 6g copper wire



WAGS® WATER HEATER SHUTOFF VALVE



W-R#	Description
1896002	WAGS® Water Only
1896004	WAGS® Water & Gas

The **original all-mechanical**, no-electricity, no-battery, no-wifi, no-maintenance water heater leak-stop solution! WAGS® prevents disastrous floods & costly insurance claims with its patented, time-tested technology.



DIELECTRIC UNIONS COPPER X FIP -LEAD FREE-



W-R#	Description	Min	Box
4226004	3/4"	1	12
4226006	1"	1	12
4226008	1 1/4"	1	6
4226010	1 1/2"	1	6
4226012	2"	1	6



DIELECTRIC NIPPLES -LEAD FREE-



W-R#	Description	Min	Box
4227004	3/4" x 3"	1	12
4227006	1" x 4"	1	12
4227008	1 1/4" x 4"	1	6
4227010	1 1/2" x 4"	1	6
4227012	2" x 4"	1	6

ELECTRICAL ACCESSORIES



1876080 1876082



1876070 1876072

TOGGLE PLATES FOR OIL AND GAS

W-R#	Description	Min	Box
1876080	1 7/8" For Gas	1	12
1876082	1 7/8" For Oil	1	12
1876070	4" For Gas	1	12
1876072	4" For Oil	1	12



1876004 1876022

ELECTRICAL BOXES

W-R#	Description	Min	Box
1876022	2" x 4" x 1 7/8" Handy Box	1	12
1876004	4" x 4" x 2 1/8" Square Box	1	12

- 1/2" knockouts



1876050 1876052 1876056



1876054 1876060 1876062

ELECTRICAL BOX COVERS

W-R#	Description	Box
1876050	4" Blank Plate	12
1876052	4" Single Toggle	12
1876056	4" Double Toggle	12
1876054	4" Single Duplex	12



1876060	1 7/8" Single Toggle	12
1876062	1 7/8" Single Duplex	12



1837025 1837001 A000930



1837040 1837050

ELECTRICAL BOX CONNECTORS

W-R#	Description	Box
1837025	3/8" BX - Squeeze	25
1837001	3/8" BX - Set Screw	25
1837050	3/8" BX - Set Screw 90° Angle	25



1837040	3/8" BX to 1/2" EMT	25
A000930	3/8/1/2" Romex	25



ONE-HOLE EMT STRAP

W-R#	Description	Box
2423050	1/2" 1-hole EMT Strap	25



ELECTRICAL ACCESSORIES



CONDUIT HANGERS



W-R#	Description	Box
2411002	1/2" Conduit Hanger	25
2411004	3/4" Conduit Hanger	25
2411006	1" Conduit Hanger	25
2411008	1 1/4" Conduit Hanger	25
2411010	1 1/2" Conduit Hanger	25
2411012	2" Conduit Hanger	25



**ROMEX®
NON-METALLIC (NM-B)
BUILDING WIRE**



W-R#	Description	Color	Length
1842102	14/2	White	50'
1842104	14/2	White	250'
1842111	12/2	Yellow	50'
1842113	12/2	Yellow	250'



**ARMORED
BUILDING WIRE**

ALUMINUM



W-R#	Description	Type	Length
1842302	14/2	MC	50'
1842304	14/2	MC	100'
1842306	14/2	MC	250'

STEEL

1842321	12/2	MC	50'
1842323	12/2	MC	100'
1842325	12/2	MC	250'

W-R#	Description	Type	Length
1842610	14/2	AC/BX	50'
1842612	14/2	AC/BX	100'
1842614	14/2	AC/BX	250'
1842631	12/2	AC/BX	50'
1842633	12/2	AC/BX	100'
1842635	12/2	AC/BX	250'



THERMOSTAT WIRE

W-R#	Feet	Ends	Gauge
1842002	500'	2	18
1842003	500'	3	18
1842004	250'	4	18

ELECTRICAL ACCESSORIES



WIRE NUTS

W-R#	Description	Min	Box
2401202	Orange	100	100
2401204	Yellow	100	100
2401206	Red	100	100
2401208	Blue	100	100
2401210	Gray	100	100



NYLON CABLE TIES



W-R#	Description	Min
1847004	4" Standard	100
1847007	7" Standard	100
1847011	11" Standard	100
1847017	17" Heavy Duty	100
1847024	24" Heavy Duty	100
1847036	36" Heavy Duty	100

- Natural color
 - Tensile Strength: Standard: 50 psi
 Heavy Duty: 175 psi



TYPE B NONMETALLIC FLEXIBLE CONDUIT



W-R#	Description	Box
1841600	1/2" X 100'	1
1841602	3/4" X 100'	1



TYPE B NONMETALLIC CONDUIT STRAIGHT CONNECTOR



W-R#	Description	Box
1842202	1/2"	25
1842204	3/4"	10

- PVC
 - UL listed



TYPE B NONMETALLIC CONDUIT -ANGLE-CONNECTOR



W-R#	Description	Box
1842206	1/2"	10
1842208	3/4"	10

- PVC
 - UL listed



PLASTIC THERMOSTAT GUARDS

W-R#	Description	H	W	D
1864001	Small	3 7/8"	3 1/2"	2 1/2"
1864002	Medium	5 1/4"	4 3/8"	3"
1864004	Large	8 1/4"	5 3/8"	3 1/2"

- Medium & Large plastic guards are furnished with Ring base & Solid base.



FIRE SPRINKLER SPECIALTIES



**VIKING® PENDANT
HEADS - 155°**

W-R#	Finish	Bulb	Viking#
2870002	CP	5 mm	VK1021
2870004	RB	5 mm	VK1021



**VIKING® UPRIGHT
HEADS - 155°**

W-R#	Finish	Bulb	Viking#
2870006	CP	5 mm	VK1001
2870008	RB	5 mm	VK1001



**VIKING® CONCEALED
HEADS - 155°**

W-R#	Finish	Bulb	Viking#
2870012	White	2.5 mm	VK4621



Quick Response



**VIKING® SIDEWALL
HEADS - 155°**

W-R#	Finish	Bulb	Viking#
2870010	Chrome	5 mm	VK305



**VIKING®
FIRE SPRINKLER
WRENCHES**

W-R#	Description	Viking#
2871002	Standard	
2871004	Concealed	



FIRE SPRINKLER SPECIALTIES



2-PART ESCUTCHEONS

W-R#	Finish	Min	Box
2872002	1/2" Chrome	1	12



C.P. SHALLOW ESCUTCHEONS

W-R#	Size	Min	Box
1610000	1/2"	25	25



C.P. PENDANT ESCUTCHEONS

W-R#	Finish	Min	Box
2872502	1/2" Chrome	1	12

- 1/2" X 3 1/2"
- Adjustable 2" to 3"
- CP Steel



FIRE SPRINKLER HEADGUARDS

W-R#	Finish	Min	Box
2872602	1/2" Red	1	12
2872604	1/2" Chrome	1	12

- One-piece, double hook construction



RECESSED FIRE SPRINKLER HEADGUARDS

W-R#	Finish	Min	Box
2872606	1/2" Chrome	1	12

- 3 1/2" Tall x 3" Wide



UL-FM APPROVED FIRE SPRINKLER GAUGE

W-R#	Description	Min	Box
1718002	Plastic Back	1	12
1718004	Steel Back	1	12



- For Air & Water
- 300 psi UL/FM approved gauge



THREE-WAY GAUGE VALVE

W-R#	Description	Min	Box
0403002	1/4" 3-way valve	1	12



- Permits inspector to check accuracy or replace gauge without shutting down entire line
- 200 psi

MALLEABLE PIPE HANGERS



JR. TOP BEAM CLAMPS

W-R#	Size	Finish	Min.	Box
2410000	3/8"	Black	1	100
2410002	1/2"	Black	1	50
2410006	3/8"	Galv.	1	100
2410008	1/2"	Galv.	1	100

"WIDE-JAW" TOP BEAM CLAMPS

W-R#	Size	Finish	Min.	Box
2410010	3/8"	Black	1	100
2410014	3/8"	Galv.	1	100



SIDE BEAM CONNECTORS

W-R#	Size	Finish	Min.	Box
2410502	3/8"	Black	1	100
2410504	1/2"	Black	1	100
2410506	3/8"	Galv.	1	100
2410508	1/2"	Galv.	1	100



THREE-HOLE CEILING PLATES

W-R#	Size	Finish	Min.	Box
2412002	3/8"	Black	1	100
2412004	1/2"	Black	1	50
2412008	3/8"	Galv.	1	100
2412010	1/2"	Galv.	1	50
2412012	3/8"	Copper	1	100



KNEE BRACKETS



W-R#	Size	Finish	Min.	Box
2430500	3/8"	Black	1	25



"C" CLAMP

W-R#	Size	Finish	Min.	Box
2432002	3/8"	Black	1	25

MALLEABLE PIPE HANGERS



**SPLIT-RING HANGER
(HINGE-TYPE)**

Hinge design makes installation easier and saves time

Note: Copper tube size hangers are epoxy-coated

W-R#	Size	Finish	Min.	Box
2413022	1/2"	Black	1	100
2413024	3/4"	Black	1	100
2413026	1"	Black	1	50
2413028	1 1/4"	Black	1	50
2413030	1 1/2"	Black	1	50
2413032	2"	Black	1	50

W-R#	Size	Finish	Min.	Box
2414022	1/2"	Galv	1	100
2414024	3/4"	Galv	1	100
2414026	1"	Galv	1	50
2414028	1 1/4"	Galv	1	50
2414030	1 1/2"	Galv	1	50
2414032	2"	Galv	1	50

W-R#	Size	Finish	Min.	Box
2415022	1/2"	Copper	1	100
2415024	3/4"	Copper	1	100
2415026	1"	Copper	1	50
2415028	1 1/4"	Copper	1	50
2415030	1 1/2"	Copper	1	50
2415032	2"	Copper	1	50



**ADJUSTABLE
GALVANIZED
SWIVEL HANGERS**



W-R#	Size	Min.	Box
2439002	1/2"	1	25
2439004	3/4"	1	25
2439006	1"	1	25
2439008	1 1/4"	1	25
2439010	1 1/2"	1	25
2439012	2"	1	25
2439014	2 1/2"	1	25
2439016	3"	1	25
2439018	4"	1	25

PIPE HANGERS



**LIGHT DUTY
STEEL
CLEVIS HANGERS**



W-R#	Size	Min.	Box
2431002	1/2"	1	25
2431004	3/4"	1	25
2431006	1"	1	25
2431008	1 1/4"	1	25
2431010	1 1/2"	1	25
2431012	2"	1	25
2431014	2 1/2"	1	25
2431016	3"	1	25
2431018	4"	1	25

HEAVY DUTY 2431020 6" 1 10



**LIGHT DUTY
-COPPERIZED-
CLEVIS HANGERS**



W-R#	Size	Min.	Box
2431500	1/2"	1	25
2431502	3/4"	1	25
2431504	1"	1	25
2431506	1 1/4"	1	25
2431508	1 1/2"	1	25
2431510	2"	1	25
2431512	2 1/2"	1	25
2431514	3"	1	25
2431516	4"	1	25



**BLACK STEEL RISER
CLAMPS**



W-R#	Size	Min.	Box
2434012	2"	1	25
2434014	3"	1	25
2434016	4"	1	25
2434018	6"	1	10

PIPE HANGERS



**PVC-COATED
DWV HANGERS**

W-R#	Size	Min.	Box
2392002	1 1/2"	1	100
2392004	2"	1	50
2392006	3"	1	25
2392008	4"	1	25
2392010	6"	1	25



**COPPERIZED
BELL HANGERS**

W-R#	Size	Min.	Box
2419002	1/2"	25	25
2419004	3/4"	25	25
2419006	1"	25	25



**COPPERIZED
MILFORD HANGERS**

W-R#	Size	Length	Min.	Box
2419502	1/2"	6"	25	25
2419504	3/4"	6"	25	25
2419506	1"	6"	25	25
2419602	1/2"	12"	25	25
2419604	3/4"	12"	25	25
2419606	1"	12"	25	25



**GALVANIZED
TWO-HOLE
PIPE STRAPS**



W-R#	Size	Min.	Box
2405004	1/2"	100	100
2405006	3/4"	100	100
2405008	1"	50	50
2405010	1 1/4"	50	50
2405012	1 1/2"	50	50
2405014	2"	25	25
2405016	2 1/2"	25	25
2405018	3"	25	25
2405020	4"	25	25



**COPPER-CLAD
TWO-HOLE
PIPE STRAPS**



W-R#	Size	Min.	Box
2422002	3/8"	100	100
2422004	1/2"	100	100
2422005	3/4"	100	100
2422006	1"	50	50
2422008	1 1/4"	50	50
2422010	1 1/2"	25	25
2422012	2"	25	25

PIPE HANGERS



PVC TUBE NAILER

W-R#	Size	Min.	Box
2330002	1/2"	50	50
2330004	3/4"	50	50

For copper, PEX, CPVC and polybutylene tubing.



PVC "ALL-AROUND" NAILER

W-R#	Size	Min.	Box
2340002	1/2"	50	50
2340004	3/4"	50	50

For copper, PEX, and polybutylene tubing.



PVC SUSPENSION CLAMP

W-R#	Size	Min.	Box
2350002	1/2"	50	50
2350004	3/4"	50	50
2350006	1"	50	50
2350008	1 1/4"	25	25
2350010	1 1/2"	25	25
2350012	2"	25	25

- For copper, PEX, and polybutylene tubing.



PVC TWO-HOLE PIPE STRAPS

W-R#	Size	Min.	Box
2360002	1/2"	50	50
2360004	3/4"	50	50
2360006	1"	50	50
2360008	1 1/4"	25	25
2360010	1 1/2"	25	25
2360012	2"	25	25

- For copper, PEX, and polybutylene tubing



PVC PIPE INSULATORS



W-R#	Size	Min.	Box
2380002	1/2"	50	50
2380004	3/4"	50	50
2380006	1"	25	25

- For copper, PEX, and polybutylene tubing



PVC METAL STUD INSULATORS



W-R#	Size	Min.	Box
2391002	1/2" - 3/4"	50	50
2391004	1"	50	50

- For copper, PEX, and polybutylene tubing

PIPE HANGERS



**COPPER CLAD
PIPE HOOKS**

W-R#	Size	Length	Min.	Box
2416004	1/2"	6"	50	50
2417004	3/4"	6"	50	50
2418004	1"	6"	50	50



**PERFORATED
DUCT HANGER IRON**

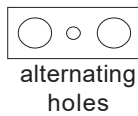

W-R#	Size	Gauge	Box
2406000	3/4" X 10'	24g (Med)	50
2406001	3/4" X 10'	28g (Light)	50
2406007	3/4" X 50'	28g (Light)	50
2406009	3/4" X 100'	28g (Light)	50

- Galvanized
- Alternating holes (1/4" & 9/64")



**PERFORATED
HANGING IRON**

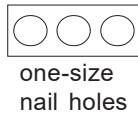

W-R#	Size	Gauge	Box
2406002	3/4" X 10'	24g (Med)	50
2407002	3/4" X 10'	18g (Heavy)	50

- Galvanized
- With one-size nail holes (1/4")

**PERFORATED
COPPERIZED
HANGING IRON**

W-R#	Gauge	Pattern	Min.	Box
2408002	3/4" X 10'	24g (Med)	50	

- 3/4" x 10 foot
- With nail holes (1/4")



**PERFORATED PVC
HANGING TAPE**

W-R#	Width	Length	Min.	Box
2409102	3/4"	10'	1	12
2409104	3/4"	25'	1	12
2409106	3/4"	50'	1	12
2409002	3/4"	100'	1	12

- Gray plastic .05 thick



**GENERAL PURPOSE
TIE WIRE**

W-R#	Length	Gauge	Min.	Box
2427002	65'	18g	1	24

PIPE HANGERS



WHITE ABS J-HOOKS

W-R#	Size	Length	Min.	Box
2390002	1 1/2"	8"	10	10
2390004	2"	8"	10	10
2390006	3"	8"	10	10
2390008	4"	8"	10	10

- Furnished with nail



STRUT CLAMPS - I.P.S.

W-R#	Size	Min.	Box
2393002	1/2" IPS	1	50
2393004	3/4" IPS	1	50
2393006	1" IPS	1	50
2393008	1 1/4" IPS	1	25
2393010	1 1/2" IPS	1	25
2393012	2" IPS	1	25
2393014	2 1/2" IPS	1	25
2393016	3" IPS	1	25
2393018	3 1/2" IPS	1	25
2393020	4" IPS	1	25

STRUT CLAMPS - C.T.S.

W-R#	Size	Min.	Box
2394002	1/2" CTS	1	50
2394004	3/4" CTS	1	50
2394006	1" CTS	1	50
2394008	1 1/4" CTS	1	25
2394010	1 1/2" CTS	1	25
2394012	2" CTS	1	25



**CUSHION CLAMPS FOR
COPPER PIPE**



W-R#	Size	Min.	Box
2395002	1/2" CTS	1	50
2395004	3/4" CTS	1	50
2395006	1" CTS	1	50
2395008	1 1/4" CTS	1	25
2395010	1 1/2" CTS	1	25
2395012	2" CTS	1	25

- Yellow zinc dichromate plated
- Insulated for vibration & corrosion resistance

PIPE HANGERS & FASTENERS



1/2" COPPER PIPE SUPPORT BRACKET

W-R#	Length	Gauge	Min.	Box
2436002	20"	16	1	50

- Copper-plated



1/2"-3/4"-1" SUPPORT BRACKET

W-R#	Length	Gauge	Min.ox
2436004	20"	16	50

- Copper-plated



DOUBLE EXPANSION SHIELDS

W-R#	Size	Min.	Box
2402102	3/8"	25	25
2402104	1/2"	25	25



DROP-IN ANCHORS

W-R#	Size	Min.	Box
2402202	3/8"	25	25
2402204	1/2"	25	25



DROP-IN ANCHOR SETTING TOOL

W-R#	Min.	Box
1808302	3/8" Tool	6



FOR WOOD



Straight Screws
For 3/8" All-thrd rod
Min. 1/4" Steel
Min 1-1/2" Wood

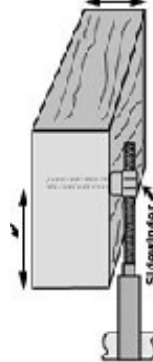

Sidewinders Screws
For 3/8" All-thrd rod
Designated by "SW"

FOR STEEL

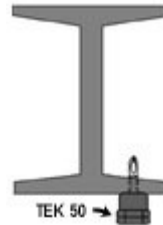

TEK 50 Self-drills & Self-taps into steel up to 1/2" thick. SWDR & DST self-drills & self-taps through 3/16" steel and accepts retainer nut.

FOR CONCRETE



Use 20 ft/lbs torque on nut. For CST use 1/4" bit & drill 2" deep in concrete.



"SAMMY" SCREWS® FOR WOOD

Fits 3/8" threaded rod

W-R#	Pattern	Length	Sammy#	Box
2440001	Straight	1"	GST-10	25
2440002	Straight	2"	GST-20	25
2440019	Straight	2 1/2"	GST-25-380	25
2440015	Straight	3"	GST-30	25
2440003	Sidewinder	1"	SWG-10	25
2440028	Sidewinder	2"	SWG-20	25
2440004	Sidewinder	2 1/2"	SWG-25-380	25
2440016	Sidewinder	3"	SWG-30	25



"SAMMY" SCREWS® FOR STEEL

Fits 3/8" threaded rod

"*" items are furnished with retaining nut

W-R#	Pattern	Length	Sammy#	Box
2440006	Straight	1"	DST-10	25
* 2440020	Straight	1"	DSTR-1	25
* 2440022	Straight	1 1/4"	DSTR516	25
2440010	Straight	1 1/2"	TEK-50	25
2440018	Straight	2"	DST-20	25
* 2440008	Sidewinder	1 1/4"	SWDR516	25
2440026	Sidewinder	1 1/2"	SWDR112	25



"SAMMY" SCREWS® FOR CONCRETE

Fits 3/8" threaded rod

W-R#	Pattern	Length	Sammy#	Box
2440012	Straight	1 1/2"	CST-20	25
2440014	Sidewinder	1 1/2"	SWC-20	25



Genuine **Sammy®** products have been the professional's choice for over 15 years. **Sammy®** screws save the contractor time and materials costs in pipe-hanging applications.



**"SAMMY X-PRESS®"
SCREWS FOR STEEL
DECK**



Sammy XPress #2440030

W-R#	Sammy#
2440030	Sammy XPress XP-20
2440044	Sammy XPress XP-35

- Sammy XPress® is a patented, unique solution for hanging rod where access to the back of the fastener is restricted (Metal Roof Deck, Tubular Steel, Etc.)
- No retaining nut required
- Must be used with installation tool #2440110.



**"SAMMY" SCREWS®
TOGGLE BOLT**

W-R#	Pattern	Length	Sammy#	Box
2440050	Straight	3"	SST-30	25

- Can be used in lath & plaster, and double 5/8" wallboard.



**"SAMMY" SCREWS®
- SETTING TOOL -**



W-R#	Sammy#
2440102	Sammy Driver 8113910
2440104	Sidewinder Driver 8114910
2440110	Sammy Xpress Tool 8194910

ALL "SAMMY" SCREWS ARE FOR 3/8" THREADED ROD



**TAPCON®
CONCRETE
ANCHORS**



HiLo® Thread pattern

W-R#	Size	Box
1333002	1/4" x 1 1/4"	100
1333004	1/4" x 1 3/4"	100
1333006	1/4" x 2 3/4"	100

- Phillips head drive
- Blue Climaseal® coating
- Original HiLo® threading

PIPE HANGERS & FASTENERS



HANGER SCREWS

W-R#	Dia.	Length	Min.	Box
2432500	3/8"	3 1/2"	1	25
2432502	3/8"	6"	1	25



THREADED STEEL RODS - GALVANIZED

W-R#	Dia.	Length	TPI	Min.	Box
2409006	3/8"	6'	16	35	35



STEEL THREADED ROD COUPLING

W-R#	Dia.	TPI	Min.	Box
2402006	3/8"	16	25	25
2402008	1/2"	13	25	25



STEEL HEX NUT FOR THREADED ROD

W-R#	Dia.	TPI	Min.	Box
2403002	1/4"	20	100	100
2403006	3/8"	16	100	100
2403008	1/2"	13	100	100



STEEL WASHER FOR THREADED ROD

W-R#	Dia.	OD	Min.	Box
2404002	1/4"	3/4"	100	100
2404100	1/4"	1 1/2"	100	50
2404006	3/8"	1"	100	100
2404102	3/8"	1 1/2"	100	50
2404008	1/2"	1 3/8"	100	100
2404104	1/2"	2"	100	50



STOVE BOLTS

W-R#	Dia.	Length	TPI	Min.	Box
2401002	1/4"	1"	20	100	100

- Round Head
- Slotted
- Zinc-plated

FASTENERS



SELF-PIERCING SHEET METAL "ZIP" SCREWS

W-R#	Dia.	Length	Box
1334010	#8	1/2"	100
1334050	#8	1/2"	1000
1334012	#8	3/4"	100
1334014	#8	1"	100

- Hard zinc plated
- Slotted hex head



SELF-DRILLING "TEK" SCREWS

W-R#	Dia.	Length	Box
1334004	#8	1/2"	100
1334006	#8	3/4"	100
1334008	#8	1"	100

- Hard zinc plated
- Slotted hex head



TOGGLE BOLTS



W-R#	Dia.	Length	Box
2402302	1/4"	4"	25
2402402	3/8"	4"	25

- Zinc Plated
- Furnished with wing



MAGNETIC NUT SETTERS

W-R#	Hex Size	Length	Box
1808320	1/4"	1 3/4"	12
1808322	5/16"	1 3/4"	12



W-R SCREW & ANCHOR KITS

W-R#	Dia.	Length	Box
2401500	3/16" (#8)	1"	25
2401502	1/4" (#10)	1"	25
2401506	5/16" (#12)	1 1/2"	25

- Each kit contains:
 - 100 hex head--phillips screws
 - 100 plastic anchors
 - 1 carbide masonry drill bit



MASONRY DRILL BIT

W-R#	Dia.	Length	Box
1812600	3/16"	4"	6
1812602	1/4"	4"	6
1812604	5/16"	4"	6
1812606	3/8"	4"	6
1812608	1/2"	4"	6

**FASTENERS
& TOOLS**

6-1 SCREW DRIVER



W-R#		Box
1808403	6-1 Screwdriver	12

- Rubberized grip
- Individually display carded

NUT DRIVERS



W-R#		Min	Box
1808452	5/16"	1	12

**NO-HUB TORQUE
WRENCH**



W-R#	Description	Min	Box
1818500	No-Hub Wrench	1	6

- 5/16" socket

**CROWN DELUXE
NO-HUB TORQUE
WRENCH**



W-R#	Description	Min	Box
1818560	60 psi Wrench	1	1

- 5/16" socket

FOLDING HEX KEY SET



W-R#		Min	Box
1818135		1	6

**T-HANDLE HEX KEY
SET**



W-R#	Size	Min	Box
1818137	9"	1	6

- 8 piece set
- 3/32", 7/64", 1/8", 9/64", 5/32", 3/16", 7/32", 1/4"

**8 PIECE ALLEN
WRENCH SET ON RING**



W-R#		Min	Box
1818140	1/16" to 1/4"	1	6

**STUD GUARDS,
PLATES & FLASHINGS**



**-TRI-POINT-
STUD GUARDS**

W-R#	Length	Gauge	Min	Box
2432610	3"	16g	250	250
2432612	6"	16g	100	100
2432620	3"	18g	250	250
2432622	5"	18g	100	100
2432624	6"	18g	100	100



**19 GAUGE
"TWIST-POINT"
STUD GUARDS**

W-R#	Length	Width	Min	Box
2432602	3"	1 1/2"	250	250
2432600	6"	1 1/2"	100	100



**16 GAUGE
2-HOLE STUD GUARDS**

W-R#	Length	Width	Min	Box
2432630	6"	1 1/2"	100	100



**16 GAUGE
FHA STRAPS**

W-R#	Length	Width	#Holes	Box
2432710	12"	1 1/2"	8	50
2432750	18"	1 1/2"	16	50
2432760	18"	5"	16	50



**16 GAUGE
5" X 8"
BOCA PLATES**

W-R#	Description	Min	Box
2432802	6-hole regular	50	50
2432806	Self-Nailing	50	50



**ALUMINUM
ROOF FLASHINGS**

W-R#	Description	Min	Box
2534204	2"	12	12
2534206	3"	12	12
2534208	4"	12	12

BRASS COMPRESSION & FLARE FITTINGS

60 COMPRESSION FERRULES



W-R#	Description	Min.	Box
2014001	1/8"	-	100
2014004	1/4"	-	100
2014008	3/8"	-	100
2014010	1/2"	-	100
2014012	5/8"	-	100
2014014	7/8"	-	100

POLY COMPRESSION FERRULES



W-R#	Description	Min.	Box
A000120	1/4"	-	100
2013600	3/8"	-	100
2013602	5/8"	-	100

61 COMPRESSION NUTS



W-R#	Description	Min.	Box
2015002	1/8" RB	-	25
2015004	1/4" RB	-	25
2015006	3/8" RB	-	25
0224002	3/8" Chrome	-	25
2015008	1/2" RB	-	25
2015010	5/8" RB	-	25
2015012	7/8" RB	-	25

61S-LF COMPRESSION CAPS



LEAD-FREE

W-R#	Description	Min.	Box
4021990	1/4"	-	25
4022000	3/8"	-	25
4022402	1/2"	-	25
4022404	5/8"	-	25

62-LF COMPRESSION UNIONS



LEAD-FREE

W-R#	Description	Min.	Box
4021002	1/8"	-	12
4021004	1/4"	-	12
4021008	3/8"	-	12
4021010	1/2"	-	12
4021012	5/8"	-	12
4021014	7/8"	-	12
4021016	3/8" x 1/4"	-	12
4021018	1/2" x 3/8"	-	12
4021020	5/8" x 3/8"	-	12
4021022	5/8" x 1/2"	-	12

64-LF COMPRESSION TEES

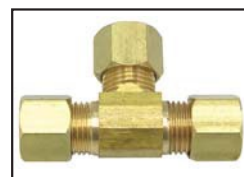

LEAD-FREE

W-R#	Description	Min.	Box
4016002	1/4"	-	12
4016004	3/8"	-	12
4016006	1/2"	-	12
4016008	5/8"	-	12
4016010	7/8"	-	12
4016014	3/8" x 1/4"	-	12
4016016	5/8" x 3/8"	-	12

BRASS COMPRESSION & FLARE FITTINGS

65-LF COMPRESSION ELBOW



W-R#	Description	Min.	Box
4017002	1/4"	-	12
4017004	3/8"	-	12
4017006	1/2"	-	12
4017008	5/8"	-	12
4017010	7/8"	-	12

66-LF COMPRESSION x FEMALE



W-R#	Description	Min.	Box
4018010	3/8" x 3/8" RB	-	12
4225012	3/8" x 3/8" Chrome-		12
4018012	3/8" x 1/2" RB	-	12
4225016	3/8" x 1/2" Chrome-		12
4018016	1/2" x 3/8" RB	-	12
4018018	1/2" x 1/2" RB	-	12
4018020	5/8" x 1/2" RB	-	12
4018022	5/8" x 3/4" RB	-	12
4018024	7/8" x 3/4" RB	-	12

68T TANK COMPRESSION FTG

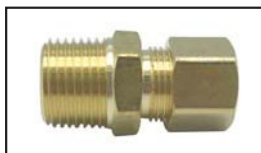

W-R#	Description	Min.	Box
2019502	3/8" x 3/8"	-	12
2019504	1/2" x 1/2"	-	12

- For use in duplex tank bushings
 - For non-potable use only

68-LF COMPRESSION x MALE



W-R#	Description	Min.	Box
4019004	1/4" x 1/8" RB	-	12
4019006	1/4" x 1/4" RB	-	12
4019008	1/4" x 3/8" RB	-	12
4019010	1/4" x 1/2" RB	-	12
4019018	3/8" x 1/4" RB	-	12
4019020	3/8" x 3/8" RB	-	12
4225010	3/8" x 3/8" Chrome-		12
4019022	3/8" x 1/2" RB	-	12
4225014	3/8" x 1/2" Chrome-		12
4019026	1/2" x 3/8" RB	-	12
4019028	1/2" x 1/2" RB	-	12
4019030	5/8" x 3/8" RB	-	12
4019032	5/8" x 1/2" RB	-	12
4019031	5/8" x 3/4" RB	-	12
4019033	7/8" x 1/2" RB	-	12
4019034	7/8" x 3/4" RB	-	12
4019036	7/8" x 1" RB	-	12

69-LF COMPRESSION x MALE ELBOW

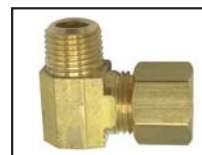

W-R#	Description	Min.	Box
4020002	1/4" x 1/8"	-	12
4020004	1/4" x 1/4"	-	12
4020016	3/8" x 1/4"	-	12
4020018	3/8" x 3/8"	-	12
4020020	3/8" x 1/2"	-	12
4020024	1/2" x 3/8"	-	12
4020026	1/2" x 1/2"	-	12
4020028	5/8" x 1/2"	-	12
4020034	7/8" x 3/4"	-	12

BRASS COMPRESSION & FLARE FITTINGS

668-LF COMPRESSION X SWEAT



LEAD-FREE

W-R#	Description	Min.	Box
4225004	3/8" RB	-	25
4225002	3/8" Chrome	-	25

70-LF COMPRESSION X FEMALE ELBOW



LEAD-FREE

W-R#	Description	Min.	Box
4023008	3/8" x 1/2"	-	12

41S SHORT FLARE NUT



W-R#	Description	Min.	Box
2001002	1/4"	-	25
2001006	3/8"	-	25
2001008	1/2"	-	25
2001010	5/8"	-	25

42 FLARE UNION



W-R#	Description	Min.	Box
2002004	1/4"	-	12
2002006	3/8"	-	12
2002008	1/2"	-	12
2002010	5/8"	-	12
2002011	1/4" x 3/8"	-	12
2002012	1/2" x 3/8"	-	12
2002014	5/8" x 3/8"	-	12
2002016	5/8" x 1/2"	-	12

48 FLARE X MALE ADAPTER



W-R#	Description	Min.	Box
2003006	1/4" x 1/4"	-	12
2003008	1/4" x 3/8"	-	12
2003016	3/8" x 1/4"	-	12
2003018	3/8" x 3/8"	-	12
2003020	3/8" x 1/2"	-	12
2003024	1/2" x 3/8"	-	12
2003026	1/2" x 1/2"	-	12
2003030	5/8" x 1/2"	-	12
2003032	5/8" x 3/4"	-	12

49 FLARE X MALE ELBOW



W-R#	Description	Min.	Box
2006002	1/4" x 1/4"	-	12
2006004	1/4" x 3/8"	-	12
2006008	3/8" x 1/4"	-	12
2006010	3/8" x 3/8"	-	12
2006012	3/8" x 1/2"	-	12
2006014	1/2" x 1/4"	-	12
2006016	1/2" x 3/8"	-	12
2006018	1/2" x 1/2"	-	12
2006020	5/8" x 1/2"	-	12

50 FLARE X FEMALE ELBOW



W-R#	Description	Min.	Box
2008012	3/8" x 1/2"	-	12
2008018	1/2" x 1/2"	-	12

BRASS COMPRESSION & FLARE FITTINGS

#56 FLARE CAP



W-R#	Description	Min.	Box
2007006	1/4"	-	12
2007008	3/8"	-	12
2007010	1/2"	-	12

125-LF HOSE BARB X MALE



LEAD-FREE

W-R#	Description	Min.	Box
4031002	1/8" x 1/8"	-	12
4031004	1/4" x 1/8"	-	12
4031006	1/4" x 1/4"	-	12
4031008	1/4" x 3/8"	-	12
4031010	3/8" x 1/4"	-	12
4031012	3/8" x 3/8"	-	12
4031014	3/8" x 1/2"	-	12
4031016	1/2" x 3/8"	-	12
4031018	1/2" x 1/2"	-	12
4031022	5/8" x 1/2"	-	12
4031024	5/8" x 3/4"	-	12
4031028	3/4" x 3/4"	-	12
4031032	1" x 1"	-	12

BRASS VENT FITTING



W-R#	Description	Min.	Box
2112000	1/2" CTS x 1/8" Tap	-	12
2112002	1/2" CTS x 1/4" Tap	-	12

IPS X SWEAT REAMED ADAPTER



LEAD-FREE

W-R#	Description	Min.	Box
4109006	1/2" CTS x 1/2" Fem Ream	-	12
4109008	3/4" CTS x 3/4" Fem Ream	-	12

• Used to solder brass pipe to copper tubing.

CPVC x MIP ADAPTER



LEAD-FREE

W-R#	Description	Box
4104004	1/2" CPVC x 1/2" MIP	12
4105004	3/4" CPVC x 3/4" MIP	12

138HM-LF HOSE BARB MENDER



LEAD-FREE

W-R#	Description	Min.	Box
4030002	1/4" x 1/4"	-	12
4030004	3/8" x 3/8"	-	12
4030006	1/2" x 1/2"	-	12

110FB FACE BUSHING



W-R#	Description	Min.	Box
2527002	1/2" x 3/8"	-	12
2527004	3/4" x 1/2"	-	12

CPVC x FIP ADAPTER



LEAD-FREE

W-R#	Description	Box
4104002	1/2" CPVC x 1/2" FIP	12
4105002	3/4" CPVC x 3/4" FIP	12

**CHROME-PLATED
NIPPLES & FITTINGS**



**CHROME-PLATED
NIPPLES
- LEAD FREE -**

3/8"IPS	1/2"IPS	LENGTH
0302502	0302544	Close (*)
0302504	0302546	Shoulder (1 1/2")
0302506	0302548	2"
0302508	0302550	2 1/2"
0302510	0302552	3"
0302512	0302554	3 1/2"
0302514	0302556	4"
0302516	0302558	4 1/2"
0302518	0302560	5"
0302520	0302562	5 1/2"
0302522	0302564	6"
0302524	--	7"
0302526	--	8"
0302534	--	12"

- Close overall length varies by diameter.
 3/8" x Close = 1" OAL
 1/2" x Close = 1 1/8" OAL



**CHROME-PLATED
COUPLINGS
- LEAD FREE -**

W-R#	Description	Min.	Box
0341402	3/8"	1	-
0341404	1/2"	1	-



**CHROME-PLATED
90° ELBOWS
- LEAD FREE -**

W-R#	Description	Min.	Box
0341002	3/8"	1	-
0341004	1/2"	1	-



**CHROME-PLATED
45° ELBOW
- LEAD FREE -**

W-R#	Description	Min.	Box
0341102	3/8"	1	-
0341104	1/2"	1	-

**CHROME-PLATED
NIPPLES & FITTINGS**



**CHROME-PLATED
TEE
- LEAD FREE -**

W-R#	Description	Min.	Box
0341502	3/8"	1	-
0341504	1/2"	1	-



**CHROME-PLATED
90° STREET ELBOW
- LEAD FREE -**

W-R#	Description	Min.	Box
0341602	3/8"	1	-
0341606	1/2"	1	-



**CHROME-PLATED
45° STREET ELBOW
- LEAD FREE -**

W-R#	Description	Min.	Box
0341608	1/2"	1	-



**CHROME-PLATED
UNION
- LEAD FREE -**

W-R#	Description	Min.	Box
0341904	1/2"	1	-



**CHROME-PLATED
CAP
- LEAD FREE -**

W-R#	Description	Min.	Box
0349014	1/2"	1	-

**BRASS EZ-BITE
PUSH FITTINGS**



E-Z BITE COUPLINGS

- LEAD FREE -

W-R#	Description	Min.	Box
2012002	1/2" X 1/2"	1	12
2012004	3/4" X 3/4"	1	12
2012008	1" X 1"	1	12



**E-Z BITE X MIP
ADAPTERS**

- LEAD FREE -

W-R#	Description	Min.	Box
2012020	1/2" X 1/2"	1	12
2012022	3/4" X 3/4"	1	12
2012026	1" X 1"	1	12



E-Z BITE ELBOWS

- LEAD FREE -

W-R#	Description	Min.	Box
2012030	1/2" X 1/2"	1	12
2012032	3/4" X 3/4"	1	12
2012036	1" X 1"	1	12



**E-Z BITE X FIP
ADAPTERS**

- LEAD FREE -

W-R#	Description	Min.	Box
2012040	1/2" X 1/2"	1	12
2012042	3/4" X 3/4"	1	12
2012046	1" X 1"	1	12



E-Z BITE TEES

- LEAD FREE -

W-R#	Description	Min.	Box
2012050	1/2" X 1/2"	1	12
2012052	3/4" X 3/4"	1	12
2012054	1" X 1"	1	12

**BRASS EZ-BITE
PUSH FITTINGS**



E-Z BITE CAPS

- LEAD FREE -

W-R#	Description	Min.	Box
2012060	1/2" X 1/2"	1	12
2012062	3/4" X 3/4"	1	12
2012064	1" X 1"	1	12



**E-Z BITE
REPAIR COUPLINGS**

- LEAD FREE -

W-R#	Description	Min.	Box
2012070	1/2" X 1/2"	1	12
2012072	3/4" X 3/4"	1	12
2012074	1" X 1"	1	12



**E-Z BITE
BALL VALVES**

- LEAD FREE -

W-R#	Description	Min.	Box
2012080	1/2" X 1/2"	1	12
2012082	3/4" X 3/4"	1	12
2012084	1" X 1"	1	12



**E-Z BITE
DROP EAR ELBOWS**

- LEAD FREE -

W-R#	Description	Min.	Box
2012300	1/2" X 1/2"	1	12



**E-Z BITE
REMOVAL TOOL**

- LEAD FREE -

W-R#	Description	Min.	Box
2012500	1/2"	1	12
2012502	3/4"	1	12
2012504	1"	1	12

**SINK
SPECIALTIES**



**FLEXIBLE BASIN
SUPPLY TUBES**

W-R#	Size (OD)	Finish	Min	Box
0209008	3/8" x 12"	CP	1	100
0209012	3/8" x 20"	CP	1	100
0209014	3/8" x 30"	CP	1	50
0209016	3/8" x 36"	CP	1	50



**FLEXIBLE TANK SUPPLY
TUBES**

W-R#	Size (OD)	Finish	Min	Box
0210002	3/8" x 12"	CP	1	100
0210006	3/8" x 20"	CP	1	100



**COMPRESSION "DELTA"
STYLE SUPPLY TUBE**

W-R#	Size (OD)	Finish	Min	Box
0215006	3/8" x 12"	CP	1	100
0215008	3/8" x 20"	CP	1	100

- Furnished with 3/8" compression nut



PEX SUPPLY TUBES

W-R#	Size (OD)	Type	Min	Box
0207006	3/8" x 20"	Basin	1	100
0207008	3/8" x 30"	Basin	1	50
0207010	3/8" x 36"	Basin	1	50

W-R#	Size (OD)	Type	Min	Box
0208002	3/8" x 12"	Tank	1	100
0208006	3/8" x 20"	Tank	1	100

SINK SPECIALTIES



BASIN COCK LOCKNUTS

W-R#	Description	Min.	Box
0906004	Brass	12	12
0906002	Die Cast	12	12
0906006	Plastic	12	12

- Fits 1/2" x 14T basin cock shanks



BASIN ROSETTES

W-R#	Description	Min.	Box
1646002	Flat	25	25
1646004	Deep	25	25
1646010	Flat Rubber	25	25



BASIN COCK COUPLING NUT

W-R#	Description	Min	Box
0912002	Brass	25	25
0912004	Brass-Plated	25	25
0912006	Plastic	25	25

- 1/2" x 14T with 1/2" supply hole



BRASS FRICTION RINGS

W-R#	Description
2712002	Basin 3/8" x 21/32" x 25/64"
2712004	Toilet 3/8" x 13/16" x 25/64"

- 100 per bag



BEVELED RUBBER BASIN SUPPLY WASHER

W-R#	Description	Box
2711008	3/8" x 23/32" x 3/8"	100



BEVELED RUBBER TANK SUPPLY WASHER

W-R#	Description	Box
2711007	3/8" x 5/16" x 27/32"	100



3/8" COMPRESSION NUT

W-R#	Finish	Min.	Box
2015006	Rough Brass	25	100
0224002	Chrome	25	100

SINK SPECIALTIES



ANGLE COMPRESSION STOPS
- LEAD FREE -

W-R#	Size	Box
4220002	3/8"OD x 3/8" IPS	10
4220004	3/8"OD x 1/2" IPS	10
4220010	3/8"OD x 1/2" SWT	10
4220014	3/8"OD x 5/8"OD	10



STRAIGHT COMPRESSION STOPS
- LEAD FREE -

W-R#	Size	Box
4220024	3/8"OD x 3/8" IPS	10
4220026	3/8"OD x 1/2" IPS	10
4220032	3/8"OD x 1/2" SWT	10
4220036	3/8"OD x 5/8"OD	10



**3/8" OD x 1/2" SWT
5" EXTENSION STOP**
- LEAD FREE -

W-R#	Pattern	Min	Box
4222002	Angle	1	10
4222004	Straight	1	10

Q.T.



ANGLE QUARTER-TURN COMPRESSION STOPS
- LEAD FREE -

W-R#	Size	Box
4220001	3/8"OD x 3/8" IPS	10
4220003	3/8"OD x 1/2" IPS	10
4220005	3/8"OD x 1/2" SWT	10
4220007	3/8"OD x 5/8"OD	10

Q.T.



STRAIGHT QUARTER-TURN COMPRESSION STOPS
- LEAD FRE -

W-R#	Size	Box
4220013	3/8"OD x 1/2 IPS	10
4220015	3/8"OD x 1/2 SWT	10
4220017	3/8"OD x 5/8 OD	10

Q.T.



**3/8" OD x 1/2" SWT
QUARTER-TURN
5" EXTENSION STOP**
- LEAD FREE -

W-R#	Size	Box
4222020	Angle	1 10

SINK SPECIALTIES



**THREE WAY STOP
- LEAD FREE -**

W-R#	Inlet	Outlets
4221002	5/8"OD	3/8"OD x 3/8"OD
4221010	1/2" IPS	3/8"OD x 3/8"OD
4221012	1/2" IPS	3/8"OD x 1/4"OD



**DUAL SHUTOFF STOP
- LEAD FREE -**

W-R#	Inlet	Outlets
4220602	5/8"OD	3/8"OD x 3/8"OD
4220604	5/8"OD	3/8"OD x 1/4"OD
4220704	1/2"IPS	3/8"OD x 1/4"OD
4220802	1/2"SWT	3/8"OD x 3/8"OD
4220804	1/2"SWT	3/8"OD x 1/4"OD



**LOOSE-KEY
ANGLE STOP
- LEAD FREE -**

W-R#	Inlet	Outlet
4220504	1/2" SWT	3/8"OD *LF*
4220506	5/8"OD	3/8"OD *LF*



**"MAX" ADAPTER
- LEAD FREE -**

W-R#	Size	Min	Box
4225030	3/8" X 3/8" X 3/8"	6	24
4225032	3/8" X 1/4" X 3/8"	6	24

- For add-on installation of water filters and ice makers. Takes an ordinary stop valve and makes it a three-way valve.



**STRAIGHT
"MAX" ADAPTER
- LEAD FREE -**

W-R#	Size	Min	Box
4225050	3/8" X 1/4"	6	24



**STRAIGHT
"MAX" SHUTOFF VALVE
- LEAD FREE -**

W-R#	Size
4220025	3/8" Fem. Comp. x 3/8" OD



**PREMIUM
"MINI-BALL" VALVES**



3/8F x 3/8 OD Comp

**DAHL MINI-BALL®
ANGLE STOPS
- LEAD FREE -**

W-R#	Size	Box
MB202LF	3/8"OD x 3/8" IPS	10
MB206LF	3/8"OD x 1/2" IPS	10
MB102LF	3/8"OD x 5/8" OD	10



3/8F x 3/8 OD Comp

**DAHL MINI-BALL®
STRAIGHT STOPS
- LEAD FREE -**

W-R#	Size	Box
MB208LF	3/8"OD x 1/2" IPS	10
MB104LF	3/8"OD x 5/8" OD	10

RetroValve

RetroValve retrofit valves and adapters offer the professional a high-quality, convenient solution to the problem of frozen valves and appliance expansion. **RetroValves** are made in Canada, and are the finest 1/4 turn valves on the market.



**STRAIGHT
RETROVALVE
- LEAD FREE -**

W-R#	Size
RV100LF	3/8" Fem. Comp. x 3/8" OD
RV104LF	1/2" Fem. Comp. x 3/8" OD



**RETROTEE
- LEAD FREE -**

W-R#	Size
RV500LF	3/8 Fem Comp x 3/8"OD x 3/8"OD
RV502LF	3/8 Fem Comp x 1/4"OD x 3/8"OD

- Allows for addition of appliances such as ice makers, dishwashers, & humidifiers--with convenient shutoff.



**CHROME-PLATED
RETRODAPTER
- LEAD FREE -**

W-R#	Min	Box
RV700LF	3/8 Fem Comp x 3/8"OD	x 3/8"OD
RV702LF	3/8 Fem Comp x 1/4"OD	x 3/8"OD

The **RV700LF C. P. RetroDapter** series provides a convenient, economical solution for the sharing of existing valves, **without the need for a shutoff.**

SINK SPECIALTIES



**CHROME-PLATED
STEEL
FLAT ESCUTCHEON**

W-R#	Size - IPS	OD	Min	Box
1610002	3/8"	2 1/2"	25	500
1610004	1/2"	2 1/2"	25	500
1610006	3/4"	2 1/2"	25	250
1610008	1"	2 7/8"	25	250
1610010	1 1/4"	2 7/8"	25	200
1610012	1 1/2"	3"	25	200
1610014	2"	3 1/2"	25	100

W-R#	Size - Copper	OD	Min	Box
1611004	5/8"OD	2 1/2"	25	500
1611006	7/8"OD	2 1/2"	25	250
1611008	1 1/8"OD	2 7/8"	25	250
* 1611009	1 1/4"OD	2 7/8"	25	200
* 1611010	1 1/2"OD	3"	25	200
* 1611012	2"OD	3"	25	100

* Denotes tubular size

Nom.	1/2"	3/4"	1"	1 1/4"	1 1/2"	2"
IPS	.84	1.05	1.32	1.66	1.90	2.38
Copper	5/8"(.63)	7/8"(.88)	1 1/8"(1.13)	1 3/8"(1.38)	1 5/8"(1.63)	2 1/8"(2.13)
Tubular				1 1/4	1 1/2	2



**WHITE PLASTIC
SURE GRIP FLAT
ESCUTCHEON**

W-R#	Size (Copper)	Min	Box
1615020	5/8"OD	25	25
1615022	7/8"OD	25	25

SINK SPECIALTIES



**CHROME-PLATED
STEEL
BELL ESCUTCHEON**

W-R#	Size - IPS	OD	Min	Box
1612002	3/8"	2 3/8"	25	25
1612004	1/2"	2 3/8"	25	25

W-R#	Size - Copper	OD	Min	Box
1613006	5/8"OD	2 3/8"	25	25
* 1613009	1 1/4"OD	3"	1	25
* 1613010	1 1/2"OD	3"	1	25

* Denotes tubular size



**CHROME-PLATED
STEEL
BOX ESCUTCHEON**

W-R#	Size - IPS	OD	Min	Box
1614002	1 1/4"	3"	5	25
1614004	1 1/2"	3"	5	25

W-R#	Size - Copper	OD	Min	Box
* 1614006	1 1/4"OD	3"	5	25
* 1614008	1 1/2"OD	3"	5	25

* Denotes tubular size



**PLASTIC
SPLIT ESCUTCHEONS**

Size (IPS)	Chrome	White
3/8" IPS	1731500	1732500
1/2" IPS	1731502	1732502
3/4" IPS	1731504	1732504
1" IPS	1731506	1732506
1 1/4" IPS	1731508	1732508
1 1/2" IPS	1731510	1732510
2" IPS	1731512	1732512
2 1/2" IPS	1731514	1732514
3" IPS	1731516	1732516
4" IPS	1731518	1732518
6" IPS	1731522	-

- 12 per box

Nom.	1/2"	3/4"	1"	1 1/4"	1 1/2"	2"
IPS	.84	1.05	1.32	1.66	1.90	2.38
Copper	5/8"(.63)	7/8"(.88)	1 1/8" (1.13)	1 3/8" (1.38)	1 5/8" (1.63)	2 1/8" (2.13)

W-R#	Size (Copper)	Finish	Min
1731602	5/8"OD	Chrome	12
1731802	5/8"OD	White	12
1731604	7/8"OD	Chrome	12
1731606	1 1/8"OD	Chrome	12
1731608	1 3/8"OD	Chrome	12
1731610	1 5/8"OD	Chrome	12
1731612	2 1/8"OD	Chrome	12

SINK SPECIALTIES



**STEEL
FLOOR AND CEILING
PLATES, LESS SPRING**

W-R#	Size - IPS	OD	Min	Box
1728000	3/8"	2 1/2"	12	144
1728002	1/2"	2 3/4"	12	144
1728004	3/4"	2 3/4"	12	144
1728006	1"	3 1/2"	12	144
1728008	1 1/4"	3 1/2"	12	144
1728010	1 1/2"	3 1/2"	12	144
1728012	2"	4 1/4"	12	120

W-R#	Size - Copper	OD	Min	Box
1730002	5/8"OD	2 3/4"	12	144
1730004	7/8"OD	2 3/4"	12	144
1730006	1 1/8"OD	2 3/4"	12	144
1730008	1 3/8"OD	3 1/2"	12	144
1730010	1 5/8"OD	3 1/2"	12	144



**HEAVY-DUTY STEEL
FLOOR AND CEILING
PLATES, WITH SPRING**

W-R#	Size - IPS	OD	Min	Box
1729000	3/8"	2 1/4"	12	144
1729002	1/2"	2 1/2"	12	144
1729004	3/4"	2 3/4"	12	144
1729006	1"	3 1/4"	12	144
1729008	1 1/4"	3 1/2"	12	144
1729010	1 1/2"	3 7/8"	12	144
1729012	2"	4 1/2"	12	120
1729014	2 1/2"	5 3/8"	12	120
1729016	3"	5 7/8"	1	12
1729018	3 1/2"	6 5/8"	1	12
1729020	4"	7 1/8"	1	12
1729022	5"	9"	1	12
1729024	6"	10"	1	12

Nom.	1/2"	3/4"	1"	1 1/4"	1 1/2"	2"
IPS	.84	1.05	1.32	1.66	1.90	2.38
Copper	5/8"(.63)	7/8"(.88)	1 1/8"(1.13)	1 3/8"(1.38)	1 5/8"(1.63)	2 1/8"(2.13)

W-R#	Size - Copper	OD	Min	Box
1731002	3/8"OD	2 3/8"	12	144
1731004	5/8"OD	2 3/8"	12	144
1731006	7/8"OD	2 3/4"	12	144
1731008	1 1/8"OD	3"	12	144
1731010	1 3/8"OD	3 1/4"	12	144
1731012	1 5/8"OD	3 5/8"	12	144
1731014	2 1/8"OD	4"	12	120
1731016	2 5/8"OD	4 7/8"	1	48
1731018	3 1/8"OD	5 1/8"	1	48

SINK SPECIALTIES



**CHROME-PLATED
STEEL COCKHOLE
COVERS**

W-R#	Description	Min.	Box
1641002	1 3/4"	1	25
1641004	2"	1	25
1641006	3"	1	12



**CHROME-PLATED
STEEL "SNAP-IN"
COCKHOLE COVER**

W-R#	Description	Min.	Box
1642002	1 3/8"	25	25
1642004	1 1/2"	25	25



**ABS
COCKHOLE COVERS**

W-R#	Description	Min.	Box
1642502	1 3/4" White	6	6



**COMBINATION
WALL MOUNT
SINK FAUCET
- LEAD FREE -**

W-R#	Description	Min.	Box
4702002	8"	1	-

• Furnished w. soap dish & 6" spout

SINK SPECIALTIES



**CHROME-PLATED
BRASS BASIN COCK
- LEAD FREE -**

W-R#	Description	Min.	Box
------	-------------	------	-----

4706002	Hot/Cold	1	6
---------	----------	---	---

- Basin cock sold individually
- Contains:
 - Hot and Cold Index Buttons
 - Plastic Locknut
 - Rubber Friction Washer
 - Brass Coupling Nut



**CHROME-PLATED
SELF-CLOSING
BASIN COCK
- LEAD FREE -**

W-R#	Description	Min.	Box
------	-------------	------	-----

4706004	Cold	1	-
4706005	Hot	1	-



Male

**BRASS PLAIN END
BIBBS
- LEAD FREE -**

W-R#	Size	Connection	Finish	Box
------	------	------------	--------	-----

4710002	1/2" IPS	Male	RB	10
4710006	1/2" IPS	Male	CP	10
4710010	1/2" IPS	Female	CP	10



Female



Adjustable
Flange Male

W-R#	Size	Connection	Finish	Box
------	------	------------	--------	-----

4711002	1/2" MIPS Adjustable	CP		10
---------	----------------------	----	--	----



Male

**BRASS HOSE END
BIBBS
- LEAD FREE -**

W-R#	Size	Connection	Finish	Box
------	------	------------	--------	-----

4709002	1/2" IPS	Male	RB	10
4709008	1/2" IPS	Male	CP	10
4709009	1/2" IPS	Female	CP	10



Female



Adjustable
Flange Male

W-R#	Size	Connection	Finish	Box
------	------	------------	--------	-----

4711004	1/2" MIPS Adjustable	CP		10
---------	----------------------	----	--	----

SINK SPECIALTIES



**CP BRASS
BUBBLER HEAD
- LEAD FREE -**

W-R#	Description	Min.	Box
4708004	3/8" Connection	1	10

- Features adjustment screw to regulate flow



**CP BRASS
BUBBLER HEAD
WITH REMOVABLE
CARTRIDGE
- LEAD FREE -**

W-R#	Description	Min.	Box
4708006	3/8" Connection	1	10

- Comparable to OEM#0362

W-R#	Description	Min.	Box
0708010	Cartridge Only	1	12

- Comparable to OEM#K361



**"LONG REACH"
WATER FILTER FAUCET
- LEAD FREE -**

W-R#	Description	Min.	Box
4708052	1/4" Connection	1	10

- Angled spout for longer span



**6" WATER FILTER
FAUCET
- LEAD FREE -**

W-R#	Description	Min.	Box
4708050	1/4" Connection	1	10

- 6" Height

SINK SPECIALTIES

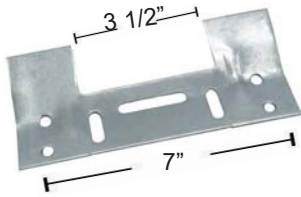

7" STEEL CHINA LAVATORY HANGER

W-R#	Description	Min.	Box
1648002	7"	1	12

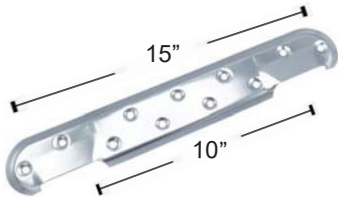

10" STEEL SINK HANGER

W-R#	Description	Min.	Box
1650002	10"	1	12

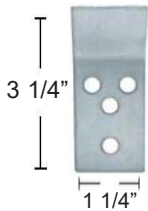

STEEL CHINA BASIN HANGER

W-R#	Description	Min.	Box
1647002	Hanger	1	12



CHROME-PLATED HEX STEEL LAVATORY LEGS

W-R#	Description	Length	Min.	Box
1602002	China	27"	1	25
1602004	China	31"	1	25
1602006	China	33"	1	25
1602010	China/IE	27"	1	25

SINK CLIP SETS



#1



#2



#3



#4
#4L



#5



#7



#10

W-R#	Pattern	Width	Reference
0713002	#1	7/16"	Huddee
0713004	#2	7/16"	
0713006	#3	3/8"	
0713008	#4	9/16"	Elkay-1 1/2"
0713020	#4L	9/16"	Elkay-2 1/8"
0713010	#5	9/16"	Kinlead
0713014	#7	9/16"	Adjustable
* 0713030	#10	11/16"	Undermount

- All sink clips are 6 per bag
 * Undermount sink clips are 4 per bag, with brass anchors
 - Furnished with 1 7/16" screws

SINK SPECIALTIES



**SPLASH GUARD
TO FIT
IN-SINKERATOR**

W-R#	Description	Min.	Box
1679004	Splash Guard	1	6



**HUSH-CUSHION
TO FIT
IN-SINKERATOR**

W-R#	Description	Min.	Box
1679006	Hush Cushion	6	6

- Gasket to fit In-sinkerator garbage disposals. Reduces vibration during disposal activity.



**MOLDED ELBOW
TO FIT
IN-SINKERATOR**

W-R#	Description	Min.	Box
1679008	Elbow	1	6



**DISPOSAL STOPPER
TO FIT
IN-SINKERATOR**

W-R#	Description	Min.	Box
1679012	Stopper	1	6



**AIR ADMITTANCE
VALVE**

**(PROVENT)
(BOCA VENT)**

W-R#	Description	Min.	Box
2430002	1 1/2" Provent	12	50

• Fits 1 1/2" female waste line adapter. Eliminates secondary stack for tubs, sinks, basins, showers and washing machines.



**FRAJON®
ASSE-APPROVED
AIR ADMITTANCE VALVE**

W-R#	Description	Min.	Box
2421002	Frajon® AAV	1	12

- ASSE approved Frajon® valves may be used in commercial, residential, and industrial buildings for individual, common, branch, and circuit vents.

- Rated up to 160 DFU's

- Designed for horizontal branch and vertical stack applications.

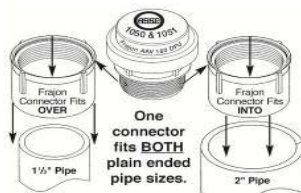

SINK SPECIALTIES



**W-R AERATOR
COUNTER DISPLAYS
- LEAD FREE -**

W-R#	Description	GPM	Count
4301001	M x F	2.2	144
4301003	Slotted M x F	2.2	144

- All dual-thread aerators are 15/16M x 55/64F



**SPRING-FLO® 38D
COUNTER DEALS
- LEAD FREE -**

W-R#	Description	GPM	Count
4307002	38D Display	2.2	144
4307120	6 per tube	2.2	6

- Aerators are 15/16M x 55/64F



**AERATOR TUBES
- LEAD FREE -**

W-R#	Description	GPM	Count
4301005	M x F	2.2	6
4301007	Slotted M x F	2.2	6
4301009	M x F Bubblestream®	2.0	6
4301030	Lo-Flo M x F	0.5	6
4301032	Lo-Flo M x F	1.0	6
4301034	Lo-Flo M x F	1.5	6

- All dual-thread aerators are 15/16M x 55/64F



**DUAL-THREAD
AERATORS
- LEAD FREE -**

W-R#	Description	GPM	Box
4305004	Standard CP	2.2	25
4305204	Slotted CP	2.2	25
4309500	Lo-Flo CP	0.5	25
4309400	Lo-Flo CP	1.0	25
4309000	Lo-Flo CP	1.5	25

**MADE IN USA
DUAL-THREAD
AERATORS
- LEAD FREE-**



W-R#	Description	GPM	Box
4305002	Standard CP	2.0	25

- All dual-thread aerators are 15/16M x 55/64F

SINK SPECIALTIES



FEMALE AERATORS
- LEAD FREE -

W-R#	Size	GPM	Box
4301002	55/64" Female	2.0	25
4304002	13/16" Female	2.0	25
4309504	13/16" Female	0.5	25



MALE AERATORS
- LEAD FREE -

W-R#	Size	GPM	Box
4302002	15/16" Male	2.0	25
4303002	13/16" Male	2.0	25
4309502	13/16" Male	0.5	25



4305504



4305502



CACHE AERATORS
- LEAD FREE -

W-R#	Size	GPM
4305502	M24 x 1	1.0
4305504	M24 x 1	2.2
4306602	Key for M24 x 1	

- Cache® aerators fit many decorator and European faucets with recessed aerators.



- 4307702** Special Delta® Kit 1.5
- 4307704** Special Moen® Kit 1.5

- Complete Kits with Aerator, Adapter, & Key



SNAP COUPLING WITH AERATOR
- LEAD FREE -

W-R#	Description	Box
4311002	Small Pattern	12
4311004	Large Pattern	12

- Snap aerator and Snap hose coupling combine to provide water source for portable washing machines & dishwashers.



CHROME-PLATED DISHWASHER AERATOR
- LEAD FREE -

W-R#	Description
4310002	M x F Snap Aerator

- For use with portable dishwasher and washing machines, or as an aerator. Fits G.E., Kitchen Aid, Westinghouse.

4310004 M x F Large Snap Aerator
-Fits Frigidaire, Hotpoint, KitchenAid, Maytag, Sears, Speed Queen, Wards, Waste King, Westinghouse.



SNAP COUPLINGS

W-R#	Description	Box
4324002	Small Coupler	12
4324004	Large Coupler	12

- Brass hose snap coupler with 3/4" male hose thread.

SINK SPECIALTIES



**CP COMBINATION
SNAP NIPPLE**
- LEAD FREE -

W-R#	Description	Box
4318002	M x F Snap Nipple	12

• For use with portable dishwasher. Small diameter, fits snap coupler #4324002. Non-aerating.



CP SWIVEL AERATORS
- LEAD FREE -

W-R#	Description	GPM	Box
4306002	M x F Swivel	2.5	12

- All dual-thread aerators are 15/16M x 55/64F
- 2.0 GPM



**CP SWIVEL/SPRAY
AERATOR**
- LEAD FREE -

W-R#	Description	Box
4301004	M x F Swivel/Spray	12

- Pull-down swivel & spray
- All dual-thread aerators are 15/16M x 55/64F



**CP WATER FILTER
DIVERTER AERATORS**
- LEAD FREE -

W-R#	Description	Box
4609004	1/4" Single barb	12
4609006	3/8" Single barb	12

- Water filter aerators are 55/64F



4313003



4313002



4323002



4312002



4313005



4326002

AERATOR ADAPTERS
- LEAD FREE -



W-R#	Side A	Side B	Box
4313003	3/4" F	15/16" M	12
4313002	15/16" M	55/64" M	12
4323002	3/4" FH	15/16" M	12
4312002	55/64" F	3/4" MH	12 *
4313005	15/16" M 55/64" F	3/4" MH	12
4326002	15/16" M 55/64" F	3/4" MH	12 *

* For non-potable use only

SINK SPECIALTIES



**“CROWN-RINSE”
SPRAY HEADS**

W-R#	Description	Min	Box
1654000	Black	1	12
1654001	White	1	12
1654005	All-Chrome	1	12

- All “Crown-rinse” products are individually boxed



**“CROWN-RINSE”
HOSE & SPRAY
ASSEMBLIES**

W-R#	Description	Min	Box
1656000	Black	1	12
1656007	Black - Delta	1	12
1656001	White	1	12
1656005	All-Chrome	1	12

- All “Crown-rinse” products are individually boxed
 - Standard Hose/Spray is furnished with 1/8” F x 1/4”F adapter
 - Delta H/S furnished with 1/2” Female Swivel



**“CROWN-RINSE”
REPLACEMENT HOSES**

W-R#	Description	Min	Box
1655000	48” Hose Only	1	12



**“CROWN-RINSE”
HOSE GUIDES**

W-R#	Description	Min	Box
1658002	Black Guide	1	12
1658004	White Guide	1	12



**LIQUID SOAP
DISPENSER**

W-R#	Description	Min	Box
1645500	Dispenser	1	12
1645504	Head Only	1	1



**LAUNDRY TRAY FAUCET
MOUNTING BLOCKS**

W-R#	Description	Min	Box
1619004	Block	1	12

- Furnished with washers & screws

SINK SPECIALTIES



**REPLACEMENT
PULL-OUT FAUCET
SPRAY HEADS**

W-R#	Finish	Min	Box
1652008	Chrome	1	6
1652009	Brushed Nickel	1	6

- OEM ref# 89-081, 051022-002, 75167
- Individually boxed



**REPLACEMENT
PULLOUT SPRAY
HOSE**

W-R#	Description	Min	Box
1652012	59" Replacement Pullout Hose	1	1



**WEIGHT FOR
PULLOUT SPRAY
HOSE**

W-R#	Description	Min	Box
1652014	Weight for Pullout Hose	1	1



**CERAMIC CARTRIDGE
FOR PULLOUT FAUCET**



W-R#	Description	Min	Box
1652020	35mm Ceramic Cartridge	1	1

- Fits 92-298

3M® WATER FILTER PRODUCTS



Aqua-Pure

3M® AP101T FILTER UNIT

W-R#	Description	Min
1991002	AP101T Filter	1

- Whole house filter (plastic body)
- Includes AP110 cartridge (5M sediment)



Aqua-Pure

3M® AP200 FILTER UNIT

W-R#	Description	Min
1991006	AP200 Filter	1

- Undersink (point-of-use) filter
- Includes AP217 cartridge (5M + CTO)



Aqua-Pure

3M® 3MFF100 FILTER UNIT

W-R#	Description	Min
1991018	3MFF100 Filter	1

- Undersink (point-of-use) filter
- Includes quick-change 3MFF101 cartridge (0.2M sediment, CTO, Cyst, Lead, & Select VOC's)



Aqua-Pure

3M® SST1HA FILTER UNIT

W-R#	Description	Min
1991022	SST1HA Filter	1

- Whole house filter (all SS body & head)
- Cartridge not included



Aqua-Pure

3M® AP430SS FILTER UNIT

W-R#	Description	Min
1991026	AP430SS Filter	1

- Scale Inhibition system for water heaters & other appliances
- Includes AP431 Cartridge (1995020)

3M® WATER FILTER PRODUCTS



Aqua-Pure

3M® AP110 CARTRIDGE

W-R#	Description	Min
------	-------------	-----

1995002	AP110 Cartridge	1
---------	-----------------	---

- Size: 2.5" x 9.75"
- 5 M sediment only



Aqua-Pure

3M® AP117 CARTRIDGE

W-R#	Description	Min
------	-------------	-----

1995004	AP117 Cartridge	1
---------	-----------------	---

- Size: 3" x 9.75"
- 5 M sediment + CTO (Chlorine Taste & Odor)



Aqua-Pure

3M® AP217 CARTRIDGE

W-R#	Description	Min
------	-------------	-----

1995006	AP217 Cartridge	2
---------	-----------------	---

- Fits AP200 filter only
- 5 M sediment + CTO (Chlorine Taste & Odor)



Aqua-Pure

3M® AP810 CARTRIDGE

W-R#	Description	Size
------	-------------	------

1995008	AP810 Cartridge	4.5" x 9.75"
1995012	AP810-2 Cartridge	4.5" x 20"

- 5 M sediment only



Aqua-Pure

3M® AP517 CARTRIDGE

W-R#	Description	Min
------	-------------	-----

1995030	AP517 Cartridge	1
---------	-----------------	---

- Fits AP510 Cartridge
- 5M sediment, scale, & CTO

3M® WATER FILTER PRODUCTS



Aqua-Pure

3M® AP817 CARTRIDGE

W-R#	Description	Size
1995010	AP817 Cartridge	4.5 x 9.75"
1995013	AP817-2 Cartridge	4.5 x 20"

- 5 M sediment + CTO (Chlorine Taste & Odor)



Aqua-Pure

3M® 3MFF101 CARTRIDGE

W-R#	Description	Min
1995014	3MFF101 Cartridge	1

- Fits 3MFF100 Undersink Filter
 - Filters 0.2M sediment, CTO, Cyst, Lead, & Select VOC's



Aqua-Pure

3M® AP5527 CARTRIDGE

W-R#	Description	Min
1995024	AP5527 Cartridges	1

- Fits AP RO-5500 Reverse Osmosis Unit
 - 5M sediment & CTO



Aqua-Pure

3M® APDW8090 CARTRIDGE SET

W-R#	Description	Min
1995018	APDW8090 Cartridges	1

- Fits AP DWS1000 Undersink Filter
 - Filters 0.2M sediment, CTO, Cyst, Lead, Select VOC's, Mercury, & Turbidity



Aqua-Pure

3M® AP431 CARTRIDGE

W-R#	Description	Min
1995020	AP431 Cartridge	1

- Fits AP430SS Filter
 - Scale inhibitor for water heaters & other appliances



Aqua-Pure

3M® AP717 ICE MAKER CARTRIDGE

W-R#	Description	Min
1996002	AP717 Cartridge	1

- Ice maker/refrigerator cartridge
 - 5M sediment, CTO & Scale

WASHING MACHINE HOSES



**3/8" ID
WASHING MACHINE
HOSE**

BAGGED#	SIZE	Min	Box
0802002	3/4" FHT x 4'	1	25
0802004	3/4" FHT x 5'	1	25
0802006	3/4" FHT x 6'	1	25
0802008	3/4" FHT x 8'	1	25
0802010	3/4" FHT x 10'	1	25
0802012	3/4" FHT x 12'	1	25

- Individually bagged with washers
- 200 psi working pressure
- 800 psi bursting
- Up to 200°F



**1/2" ID
HIGH-CAPACITY
WASHING MACHINE
HOSE**

BAGGED#	SIZE	Min	Box
0802504	3/4" FHT x 4'	1	25
0802505	3/4" FHT x 5'	1	25
0802506	3/4" FHT x 6'	1	25
0802508	3/4" FHT x 8'	1	25
0802512	3/4" FHT x 12'	1	25

- Individually bagged with washers
- GOODYEAR Horizon™ Nylon-reinforced hose
- 200 psi working pressure - 200°F rating



**ULTRA® TRIPLEX
STAINLESS STEEL
WASHING MACHINE
HOSES**

BAGGED#	SIZE	Min
0802702	3/4" FHT x 6'	1 PR.

- Sold in pairs (1 red, 1 blue)
- 3 ply construction:
 1. Nylon reinforced EPDM rubber
 2. Stainless Steel braiding
 3. PVC overbraid cover (red/blue)
- Brass fittings



**3/8" ID
WASHING MACHINE
HOSE WITH ELBOW**

BAGGED#	SIZE	Min	Box
0802302	3/4" FHT x 4'	1	25
0802304	3/4" FHT x 5'	1	25
0802306	3/4" FHT x 6'	1	25

- Individually bagged with washers



"Y" HOSE MIXER

W-R#	SIZE	Min	Box
0805003	Bagged	1	25

- Inlet branches are FHT, outlet is MHT
- With washers

WASHING MACHINE HOSES



WASHING MACHINE DISCHARGE HOSE - STANDARD -

Regular	SIZE	Min
---------	------	-----

0807002 5/8" ID x 50' 1 coil

0807008 1" ID x 50' 1 coil



WASHING MACHINE DISCHARGE HOSE - REINFORCED -

Reinforced	SIZE	Min
------------	------	-----

0808002 5/8" ID x 50' 1 coil

0808006 7/8" ID x 50' 1 coil

0808008 1" ID x 50' 1 coil



ALUMINUM HOOK FOR WASHING MACHINE DISCHARGE HOSE

W-R#	SIZE	Min	Box
------	------	-----	-----

0806004 1" Hook 1 12



HOOK HOSE FOR WASHING MACHINE DISCHARGE

W-R#	SIZE	Min	Box
------	------	-----	-----

0807010 5' Hose 1 12

- Gray corrugated tubing
- Molded Adapter for Washing Machine connection. Step down 3/4", 7/8" & 1"



CORRUGATED DISHWASHER DRAIN HOSE

W-R#	SIZE	Min	Box
------	------	-----	-----

0807020 6' Hose 1 12

- Gray corrugated tubing with clamps
- Molded Adapters fit 3/4", 7/8" & 1"



DISHWASHER DISPOSAL CONNECTION

W-R#	SIZE	Min	Box
------	------	-----	-----

1677002 Connection 1 50

- Improved connector with 2 stainless steel worm gear hose clamps



ALUMINUM LINT SNARE

W-R#	SIZE	Min	Box
------	------	-----	-----

0527600 Fits 1" ID 1 12

- Roll over the end of discharge hose to prevent drain blockage from lint discharge.



TWIN MIX CONNECTION

W-R#	SIZE	Min	Box
------	------	-----	-----

0818002 1 12

- For installation of portable washing machines

HOSES & HOSE SPECIALTIES



**CLEAR VINYL
CONDENSATE TUBING**

W-R#	I.D.	O.D.	Length
0809002	1/4"	3/8"	100'
0809006	3/8"	1/2"	100'
0809008	1/2"	5/8"	100'
0809010	5/8"	7/8"	100'
0809012	3/4"	1"	50'



**CLEAR VINYL
TUBING--FDA COMPLIANT**

W-R#	I.D.	O.D.	Length
0819500	1/8"	3/16"	100'
0819501	1/8"	1/4"	100'
0819520	3/16"	5/16"	100'
0819502	1/4"	3/8"	100'
0819504	5/16"	7/16"	100'
0819524	5/16"	1/2"	100'
0819506	3/8"	1/2"	100'
0819528	3/8"	9/16"	100'
0819508	1/2"	5/8"	100'
0819532	1/2"	3/4"	100'
0819510	5/8"	7/8"	100'
0819512	3/4"	1"	50'
0819536	7/8"	1 1/8"	50'
0819514	1"	1 1/4"	50'

- Non-toxic FDA grade material
- Temperature range: 25°F to 150°F
- Dispenser box



**WHITE POLYETHYLENE
TUBING**

W-R#	OD	Length
0809020	1/4"	100'
0809022	5/16"	100'
0809024	3/8"	100'
0809026	1/2"	100'
0809028	5/8"	100'

- Non-toxic FDA grade material
- Temperature range: 25°F to 150°F
- Dispenser box

HOSES & HOSE SPECIALTIES



**BRASS INSERT
STIFFENER
- LEAD FREE -**



W-R#	SIZE	Min	Box
4A00119	1/4" Insert	25	25
4022002	3/8" Insert	25	25
4022004	1/2" Insert	25	25

HOSE CLAMPS



CARBON	STAINLESS	SAE	Min.	Max.
2208004	2209004	#4	7/32"	5/8"
2208006	2209006	#6	7/16"	25/32"
2208008	2209008	#8	7/16"	29/32"
2208010	2209010	#10	9/16"	1 1/16"
2208012	2209012	#12	11/16"	1 1/4"
2208016	2209016	#16	3/4"	1 1/2"
2208020	2209020	#20	13/16"	1 3/4"
2208024	2209024	#24	1 1/16"	2"
2208028	2209028	#28	1 5/16"	2 1/4"
2208032	2209032	#32	1 9/16"	2 1/2"
2208036	2209036	#36	1 13/16"	2 3/4"
2208040	2209040	#40	2 1/16"	3"
2208048	2209048	#48	2 9/16"	3 1/2"
2208052	2209052	#52	2 13/16"	3 3/4"
2208072	2209072	#72	4 1/16"	5"
2208088	2209088	#88	5 1/16"	6"
2208104	2209104	#104	6 1/16"	7"

- 10 per box



**3/4" HOSE VACUUM
BREAKER**

W-R#		Min	Box
0418000	Non-potable	1	12
4418000	Lead Free	1	12

- With break-off set screw
- FH x MH connection

HOSES & HOSE SPECIALTIES



3/4" FHT HOSE CAP

W-R#		Min	Box
4607002	Lead-Free Brass	12	12
2606002	Brass Plated	12	12
2605002	Plastic	12	12

- Brass hose caps furnished with washer



3/4" FHT HOSE CAP WITH CHAIN

W-R#		Min	Box
2607004	Brass	1	12

- Furnished with washer and 6" chain



HOSE NIPPLES - LEAD FREE

WR#	Size	Box
4610002	3/4" MH x 3/4" MIP	12
4610004	3/4" MH x 1/2" MIP	12
4610006	3/4" MH x 3/4" MH	12
4610008	3/4" MH x 1/2" MIP x 1/2" SWT	12
4610010	3/4" MH x 3/4" MIP x 1/2" FIP	12



WR#	Size	Box
4610012	3/4" MH x 3/4" FIP	12
4610014	3/4" MH x 1/2" FIP	12



WR#	Size	Box
4610016	3/4" FH x 3/4" FIP	12
4610018	3/4" FH x 1/2" FIP	12
4610020	3/4" FH x 3/4" FH	12



WR#	Size	Box
4610028	3/4" FH x 1/2" MIP	12
4610030	3/4" FH x 3/4" MIP	12
4610032	3/4" FH x 1/2" MIP x 1/2" SWT	12



SWIVEL HOSE NIPPLES - LEAD FREE

WR#	Size	Box
4610022	3/4" FH x 3/4" FIP	12
4610024	3/4" FH x 1/2" FIP	12
4610026	3/4" FH x 3/4" FH	12

- All hose nipples are 12 per bag

HOSES & HOSE SPECIALTIES

	RUBBER HOSE WASHERS	W-R#	Min	Box
		2724002 Bulk	100	100

	INLET HOSE FILTER SCREEN	W-R#	Min	Box
		0533002	25	25

 <small>swivel connection</small>	SIAMESE 3/4" HOSE CONNECTION WITH SHUT OFF	W-R#	Min	Box
		2601002 Die Cast	1	12
		4603003 Lead Free Brass	1	12

- For outdoor watering use

	3/4" SIAMESE CONNECTION	W-R#	Min	Box
		2602002 Die Cast	1	12
		2603002 Brass	1	12

- For outdoor watering use

	HOSE BIBB MOUNTING PLATE	W-R#	Min	Box
		0623602 Mounting Plate	1	12

NEW!

- Zinc-plated steel plate to cover annular space around hose bibbs and sillcocks.
- Mounting hardware included

	HOSE BIBB ANCHORING KIT	W-R#	Min	Box
		0624502 Hose Bibb Anchoring Kit	1	12

NEW!

- Convenient method of securing water lines and faucets to exterior walls.

HOSES & HOSE SPECIALTIES



**VANDAL-PROOF
QUARTER-TURN
SILLCOCKS
- LEAD FREE**

W-R#		Min	Box
4404002	1/2" IPS	1	12
- For outdoor watering use			



**"HOSE-MATE"
SILLCOCK RETROFIT
VALVE -LEAD FREE -**

W-R#		Box
RV900LF	3/4 FH Swivel x MH	6

The **RV900 "Hose-Mate"** is a rugged, machined-brass solution for frozen sillcocks or other hose connections.



**DIE CAST
VALVE HANDLE**

W-R#		Min	Box
0420002	Square	1	12
0420004	Round	1	12
- 12 pt			



SILLCOCK KEY

W-R#		Min	Box
0421002	5/16"	1	12
0421000	1/4"	1	12



4-WAY SILLCOCK KEY

W-R#		Min	Box
0421004		1	12

- Fits stems 1/4", 9/32", 5/16" and 11/32"



**STOP AND WASTE
CAPS**

With washer

W-R#		Min	Box
0419006	5/16"	10	10
0419008	3/8"	10	10



**FIRE HYDRANT TO
3/4"MH ADAPTER**

W-R#		Min	Box
2604002	2 1/2" Hydrant	1	-



**"BIBBLOCK" HOSE
BIBB LOCKOUT**

W-R#		Min	Box
2607500	"Bibblock"	1	-

- Eliminates unauthorized use of water!
- Vandal-proof design!
- Lock sold separately.

HOSES & HOSE SPECIALTIES



5/8" GARDEN HOSES



W-R#		Min	Box
1803000	50' Tire Cord	1	5
1803002	50' Rubber/Vinyl	1	5
1803006	50' Premium	1	5
1803008	25' Premium	1	5

- Premium Rubber Hoses 1803006 & 8 rated for temperatures up to 180°



6-SPRAY PISTOL GRIP HOSE NOZZLE

W-R#	
2609502	7" 6-Pattern Spray

- Durable Metal Construction
- Insulated Handle Grip for hot & cold applications
- Soft Cushioned Grip



INSULATED PISTOL GRIP HOSE NOZZLE

W-R#	
2609702	Heavy-Duty Insulated

- Solid Metal Body
- Insulated Handle Grip for hot & cold applications
- Nylon Handle



BRASS TWIST HOSE NOZZLE

W-R#	
2609602	7" Brass Twist Nozzle

- Durable Metal Construction
- Insulated Handle Grip for hot & cold applications
- Soft Cushioned Grip



C.P. ECONOMY PISTOL GRIP HOSE NOZZLE

W-R#	Min	Box
2609002	1	12



4" BRASS HOSE NOZZLE

W-R#	Min	Box
2608002	1	12

HOSES & HOSE SPECIALTIES



AMES® HOSE REELS

W-R#		Min
1803502	Poly Hose Hanger	1
1803504	Wall Mount Hose Reel	1



**WATER HAMMER ARRESTERS
- LEAD FREE -**

W-R#		Min	Box
4320002	1/2" MIP	1	12
4320004	1/2" Sweat	1	12

- rated to 200 psi

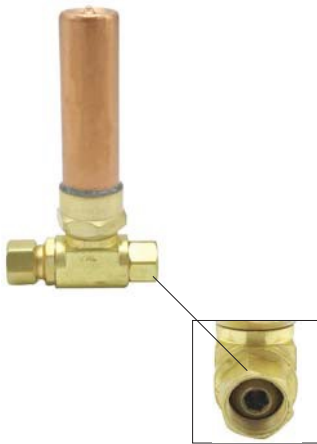

**WATER HAMMER COMPRESSION
RETROFIT TEES
- LEAD FREE -**

W-R#	Description	Min
4320020	3/8" OD X 3/8" Female Compression	1

3/8" OD Female connection to fit existing stops

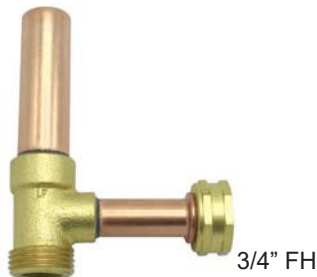

**WATER HAMMER ARRESTER FOR WASHING MACHINE
- LEAD FREE -**

W-R#	Description	Min
4320030	3/4" FH X 3/4" MH	1

3/4" MH

3/4" FH

HOSES & HOSE SPECIALTIES

SEWAGE EJECTOR CHECK VALVE



W-R#		Min	Box
0414204	1½" I.P.S.	1	24
0414206	2" I.P.S.	1	24
0414208	1 1/2" x 1 1/4"	1	24
0414210	3" w/Cast Iron Body	1	24

COMPRESSION SEWAGE EJECTOR CHECK VALVE



W-R#		Min	
0414606	2" Compression	1	

"SILENT-CHECK" SEWAGE EJECTOR CHECK VALVE



W-R#		Min	
0414302	1 1/2" Silent Check	1	
0414304	2" Silent Check	1	
0414706	2" Silent Check -Compression-	1	
0414806	2" Silent Check -True Union-	1	
0414812	2" Silent Check -True Union- with Ball Valve	1	



PVC DWV BACKWATER VALVES



W-R#		Min	Box
0417402	2" PVC	1	8
0417404	3" PVC	1	6
0417406	4" PVC	1	6

CAST IRON BACKWATER VALVE - NO-HUB



W-R#	Description
0414906	4" No-Hub Backwater Valve - Removable Brass Flapper



HOSES & HOSE SPECIALTIES



SUMP PUMP DRAIN HOSE KIT



W-R#		Min	Box
0810002	1 1/4" X 24'	1	8
0810004	1 1/2" X 24'	1	6
0810010	1 1/2" MIP X 1 1/4" Adapter	1	12

• Included in kit are 24' corrugated plastic hose, 1 1/4" plastic male adapter and stainless clamp, individually packaged.



GAS RANGE CONNECTOR ADAPTER

W-R#		Min	Box
0814102	5/8" Flare x 1/2" FIP		25
0814104	5/8" Flare x 3/4" FIP		25
0814106	5/8" Flare x 1/2" MIP		25
0814108	5/8" Flare x 3/4" MIP		25



STAINLESS STEEL GAS RANGE CONNECTOR

W-R#		Min	Box
0813004	24"	1	12
0813008	36"	1	12
0813012	48"	1	12
0813014	60"	1	12
0813016	72"	1	12

- 3/4" MIP (1/2" FIP) x 1/2" MIP



CSA GAS BALL VALVES

W-R#	Description	Min	Box
0400120	1/2"	12	12
0400122	3/4"	12	12

HOSES & HOSE SPECIALTIES



4" x 8 FOOT DRYER VENT KITS



W-R#	Hose	Hood	Ctn
0811102	Lamaflex®	Metal	8
0811104	Aluminum	Plastic	8
0811108	Aluminum	Metal	8

Hose Types:
 "Lamaflex" = Laminated aluminum ducting
 "Aluminum" = corrugated flexible aluminum



HOOD & TAIL FOR DRYER VENT



W-R#	Size	Ctn
0811005	4" White Plastic	6
0812010	4" Metal	6

0812030	4" White Plastic Louvered	6
---------	---------------------------	---

- Contains hood, 11" tail pipe, & white trim plate



REPLACEMENT HOOD ONLY FOR DRYER VENT



W-R#	Color	Min	Ctn
0811022	4" White Hood with Screen	1	12

- Fits 4" dryer vent tail pipe



REPLACEMENT LOUVERED HOOD ONLY FOR DRYER VENT



W-R#	Size	Min	Ctn
0811020	4" Louvered White Hood	1	12

- Fits 4" dryer vent tail pipe



UNIVERSAL DRYER VENT GUARD



W-R#	Size	Min	Ctn
0812042	Dryer Vent Guard	1	12

- Fits over existing dryer vent hood to prevent pest intrusion.



4" UNDER EAVE SOFIT VENT



W-R#	Size	Min	Ctn
0812028	4" Under Eave Soffit Vent	1	6

HOSES & HOSE SPECIALTIES



DRYER VENT HOSE



W-R#	Size	Hose	Ctn
0812001	4" x 8'	Lamaflex®	10
0812007	4" x 20'	Lamaflex®	6
0812005	4" x 50'	Lamaflex®	1
<hr/>			
0812003	4" x 8'	Aluminum	10



4" ALUMINUM DRYER VENT COUPLING



W-R#	Size	Ctn
0812020	4" Coupling	6



4" ALUMINUM DRYER VENT PIPE



W-R#	Size	Ctn
0812026	4" x 24"	1



4" ALUMINUM DRYER VENT ELBOW



W-R#	Size	Ctn
0812024	4" Elbow	6



DRYER VENT CLAMP



W-R#	Size	Ctn
0812008	4" Clamp Only	12



LINT TRAP INDOOR DRYER VENT KIT



W-R#	Size	Ctn
0811012	Lamaflex® Hose	12

- 4" x 5' hose
- For use on electric dryers only



4" DRAFT BLOCKER KIT



W-R#	Size	Ctn
0812040	4" PVC Draft Blocker	6

- Prevents backflow of air in ventilation fans

HOSES & HOSE SPECIALTIES



PLASTIC ICE MAKER KITS - LEAD FREE-

W-R#		Min	Box
4816002	Deluxe	1	24

- Contains valve, compression elbow, and extra fittings.

W-R#		Min	Box
4816004	Economy	1	24

- Valve with 3/8" O.D. coupling.



COPPER ICE MAKER KITS -LEAD FREE-

W-R#		Min	Box
4816006	15 Foot	1	36
4816008	25 Foot	1	36

- Contains compression elbow, and extra fittings to cover every installation contingency.



ELBOW FOR ICE MAKER & DISHWASHER - LEAD FREE -

W-R#		Box
4816010	For Ice Maker (1/4" OD x 3/4" FHT)	6
4816020	For Dishwasher (3/8"OD x 3/4 FHT)	6



SELF-TAPPING SADDLE VALVES - LEAD FREE -

W-R#	Description	Min	Box
4415004	Hollow Needle	1	50
4415002	Solid Needle	1	50

- Connects 1/4" ice makers & water filters to copper tubing from 3/8" to 1 3/8".



NEEDLE VALVES - LEAD FREE -

W-R#	Description	Min	Box
4415006	1/4" OD X 1/4" OD	1	12
4415008	3/8" OD X 3/8" OD	1	12

HOSES & HOSE SPECIALTIES



WATER FILTRATION PRODUCTS

W-R#	Description	Box
0590002	10" Nylon-Wound	12
0590004	10" Poly-Groove	12

- 5 Micron filters
- Protects against rust, sediment, silt & rust



1/4 TURN BALL VALVE WASHING MACHINE BOX



W-R#	Min	Box
0431008	1/4 Turn Valves 1	10

- PVC Box with nailing brackets
- 1/4 Turn Brass Ball Valves
- IPS x SWT Connections



1/4 TURN BALL VALVE WASHING MACHINE BOX - WITH ARRESTERS



W-R#	Min	Box
0431010	1/4 Turn Valves 1 with arresters	10

- PVC Box with nailing brackets
- 1/4 Turn Brass Ball Valves
- IPS x SWT Connections



1/4 TURN STOP ICE-MAKER BOX - LEAD FREE -



W-R#	Min	Box
4430006	1/4 Turn Stop 1	10

- PVC Box with nailing brackets
- 1/4 Turn Compression Stop
- IPS x SWT Connection



SNAP-IN PLASTIC ACCESS PANELS

W-R#	Min	Box
2213002	6" X 9"	1 12
2213004	8" X 8"	1 12
2213006	14" x 14"	1 12

**CROWN "JEWEL" PRERINSE
FAUCET PARTS**

**SPRAY VALVE
ASSEMBLY**



W-R#	Description	Min.	Box
------	-------------	------	-----

CJ001 Spray Valve 1 1

- Heavy pattern
- Chrome-plated brass body
- Plastic handle
- Individually boxed
- Comparable to OEM# B-107

**REPLACEMENT
BONNET ASSEMBLY
FOR PRE-RINSE**



W-R#	Description	Min.	Box
------	-------------	------	-----

CJ003 Bonnet 1 1

- Heavy pattern CP brass
- Comparable to OEM#2856-40
- Individually bagged

**REPLACEMENT HOSE
FOR PRE-RINSE**



W-R#	Description	Min.	Box
------	-------------	------	-----

CJ101 44" Hose 1 1

- Flexible Stainless Steel Hose
- Heavy duty black plastic handle
- Comparable to OEM# B-0044-H

**REPLACEMENT
HANDLES FOR
PRE-RINSE**



W-R#	Description	Min.	Box
------	-------------	------	-----

CJ302 fits Eterna 1 pr. 1

- Furnished with index buttons
- Comparable to OEM# 1636-45 & 1637-45

**REPLACEMENT STEM
& BARREL FOR
PRE-RINSE
- LEAD FREE -**



W-R#	Description	Min.	Box
------	-------------	------	-----

CJ401HLF Hot 1 1

- Comparable to OEM# 788-20/811-25

CJ401CLF Cold 1 1

- Comparable to OEM# 789-20/812-25

**REPLACEMENT
SPINDLE ASSEMBLY
FOR PRE-RINSE
- LEAD FREE -**



W-R#	Description	Min.	Box
------	-------------	------	-----

CJ500HLF Hot 1 1

- Comparable to OEM# 2714-40

CJ500CLF Cold 1 1

- Comparable to OEM# 2713-40

STRAINERS & DRAINS



**HEAVY DUTY CP
CAST BRASS
DUO STRAINER**

W-R#	Description	Min.	Box
0515004	CP Brass Duo	1	50

- Extra heavy cast brass construction with a mirror finish chrome plate. This is a top quality strainer, utilizing a machined, chrome plated brass seat, for a superior seal.
- Similar to KOHLER strainer.



**STAINLESS STEEL
DUO STRAINER**

W-R#	Description	Min.	Box
0515002	S.S. Duo	1	50

- 4½" dia. to fit 3½" drilling. Regular pattern.
- Zinc die cast locknut.



**DEEP-CUP STAINLESS
STEEL DUO STRAINER**

W-R#	Description	Min.	Box
0515006	Deep Cup Duo	1	50

- Die cast nuts
- Regular "plug&pin" stopper



**"TWIST-AND-LOCK"
STAINLESS STEEL
DUO STRAINER**

W-R#	Description	Min.	Box
0515008	Twist-N-Lock	1	50

- 4½" dia. to fit 3½" drilling.
- Basket threads into base of strainer to create a more positive seal

STRAINERS & DRAINS



REPLACEMENT BASKET STRAINER WITH CP BRASS STOPPER

W-R#	Description	Min.	Box
0518500	Fits Am. Std.	1	50



REPLACEMENT BASKET STRAINER WITH SINGLE-PRONG

W-R#	Description	Min.	Box
0519002	Single-prong	1	50



REPLACEMENT BASKET STRAINER WITH RUBBER STOPPER

W-R#	Description	Min.	Box
0517002	Plastic Pin	1	50



DUO STRAINER WASHER

W-R#	Description	Min.	Box
2713002	Rubber	25	25
2713004	Metal	12	12

- 4 3/8" x 3 3/8"



DUO STRAINER LOCKNUT

W-R#	Description	Min.	Box
0907002	Die Cast Nut	1	12



CHROME-PLATED LARGE FLAT SINK PLUG

W-R#	Description	Min.	Box
0513002	Sink Plug	1	50

- 4 1/2" diameter
- fits 1 7/8" drilling



DUPLEX SINK STRAINER WITH GRID

W-R#	Description	Min.	Box
0508002	CP Brass	1	12
0509002	Stainless Steel	1	12



DUPLEX WASH TRAY PLUG WITH STOPPER

W-R#	Description	Min.	Box
0511002	CP Brass	1	12
0512002	Stainless Steel	1	12

- 2 7/8" dia. to fit 1 7/8" drilling.

STRAINERS & DRAINS



**STAINLESS STEEL
JUNIOR DUO STRAINER**

W-R#	Description	Min.	Box
0505002	Jr. Duo	1	12

• 2⁷/₈" dia. to fit 1⁷/₈" drilling



**DEEP BASKET JUNIOR
DUO STRAINER**

W-R#	Description	Min.	Box
0505004	Deep Jr. Duo	1	12



**REPLACEMENT BASKET
FOR JUNIOR DUO**

W-R#	Description	Min.	Box
0506002	Jr. Duo Basket	1	12
0505003	Deep Jr. Duo Basket (2")	1	12



**3" LONG SHANK
BRASS SINK PLUG**

W-R#	Description	Min.	Box
0506500	3" Brass Plug	1	5

• 3"OD x 1¹/₂"ID x 3" long
• Ideal for old cast iron installations
• Furnished with locknut & rubber washer



1" BRASS BAR PLUG

W-R#	Description	Min.	Box
0504002	1 1/2"	1	6
0504006	1 1/2" w/tail	1	6
0504004	3"	1	6
0504008	3" w/tail	1	6



**1"OD TAIL FOR BAR
PLUG**

W-R#	Description	Min.	Box
0504102	1"OD x 2"	1	6



**CAST IRON
SINK COLLARS**

W-R#	Description	Min.	Box
0509500	2"ID	1	12

- 3 1/2" between centers

STRAINERS & DRAINS



**1 1/4" BRASS
POP-UP WASTE
ASSEMBLY**

W-R#	Description	Min.	Box
1405002	Chrome	1	25
1405003	Polished Brass	1	25



**REPLACEMENT PARTS
FOR CP POP-UP DRAIN**



W-R#	Description	Min
1405102	Pull Rod & Pivot	1
1405104	Universal Stopper	1



**1 1/4" CHROME-PLATED
BRASS SINK DRAINS
FOR VESSEL SINKS**



W-R#	Description	Min.	Box
1406002	With Overflow	1	25
1406004	Without Overflow	1	25

- Umbrella plug design
- Touch-operated--no lift rod



**CHROME-PLATED
CAST BRASS
GRID DRAIN**

W-R#	Description	Min.	Box
0512500	1 1/4" Grid Drain	1	25

- 1 1/4" X 6", 17 gauge tailpiece



**CHROME-PLATED
CAST BRASS
OFFSET
1 1/4" GRID DRAIN**

W-R#	Description	Min.	Box
0512508	Offset	1	25

- Cast Brass strainer & elbow
- 17 gauge offset tubular brass tailpiece

STRAINERS & DRAINS



CHROME-PLATED TUBULAR TRAP PRIMER TAILPIECES

W-R#	Description	Box
0117202	1 1/4" X 8" Fine Thread	25
0117204	1 1/2" X 8" Direct Connect	25

- 17 gauge tubular brass
- One piece construction
- Meets Dade County building code



CHROME-PLATED CAST BRASS P.O. PLUG

W-R#	Description	Min.	Box
0503000	1 1/4" PO Plug	1	12

- 4" 20 gauge tailpiece
- P.O. plugs have overflow holes



One-piece Two-piece

CHROME-PLATED TUBULAR BRASS P.O. PLUG

Size	One-Piece	Two-Piece
1 1/4"x12"	0501006	0502006

- Chrome-plated tubular brass
- P.O. plugs have overflow holes



CHROME-PLATED TUBULAR BRASS C.O. PLUG

W-R#	Description	Min.	Box
0503002	1 1/4" CO Plug	1	12

- Chrome-plated tubular brass
- C.O. plugs do not have overflow holes



MACK WASHER

W-R#	Description	Min.	Box
2719002	1 1/4" Basin	12	12
2719004	1 1/2" Bath	12	12



NICKEL-PLATED STEEL KETCHALL STRAINER

W-R#	Description	Size	Min.
0528002	Sink	1 7/8"	10
0528004	Basin	1 1/4"	10
0528006	Wash Tray	1 1/2"	10



KETCHALL SINK STRAINER WITH POST

W-R#	Description	Size	Min.
0528008	Sink w/post	1 7/8"	10

STRAINERS & DRAINS



STAINLESS STEEL MESH STRAINER

W-R#	Size	Min.	Box
0529502	4 3/8"	10	10
0529504	2 3/4"	10	10
0529506	2 1/8"	10	10



DRAIN PROTECTOR

W-R#	Size	Min.	Box
0532002	3" Perforated Steel Strainer	12	12



CHROME-PLATED STEEL FLAT STRAINERS

W-R#	Size (OD)	Min.	Box
0525004	1 1/2"	10	10
0525012	2 3/4"	10	10



CHROME-PLATED STEEL THREE-PRONG STRAINERS

W-R#	Description	Min.	Box
0526002	1 5/8"	12	12
0526004	1 7/8"	12	12



CHROME-PLATED STEEL SHOULDER STRAINER

W-R#	Description	Min.	Box
0527004	2 3/4" x 1/4"	12	12



YELLOW PVC TAILPIECE CHECKVALVE

W-R#	Description	Min.	Box
0414502	PVC Checkvalve	1	24

- Fits 1 1/2" Tailpiece
- Used to prevent backflow into sink from dishwashers, etc.

LAVATORY POP-UP STOPPER FOR DELTA



W-R#	Description	Top	Length
1673006	Delta	1 3/8"	5 1/8"
1405104	Fitall	1 3/16"	3 3/16"

STRAINERS & DRAINS



**CHROME-PLATED
SHOWER STALL
STRAINER**

W-R#	Description	Min.	Box
0522004	1 1/2" Brass	1	12
0522006	2" Die Cast	1	12
0522008	2" Brass	1	12



**CHROME-PLATED
BRASS URINAL
STRAINER**

W-R#	Description	Min.	Box
0521002	2" IPS	1	24
0521004	2" DWV	1	24



**EXTRA-LONG BRASS
URINAL/SHOWER
STRAINER**

W-R#	Description	Min.	Box
0521020	2" IPS	1	24

- For use on extra-thick mud/tile jobs
- Overall spud length of 2 1/2"



**CHROME-PLATED
SHOWER STALL
GRID**

W-R#	Description	Min.	Box
0530002	3 1/2" OD	12	12

- fits urinal strainers
- 2 3/4" between holes



**NO-CAULK SHOWER
DRAINS WITH
STAINLESS-STEEL GRID**

W-R#	Description	Min.	Box
0523004	2" Brass	1	24
0523005	2" PVC	1	24

- Includes jiffy joint, locking ring, & wrench



Includes locking ring & wrench



2" PVC SHOWER DRAINS

W-R#	Connection	Grid	Min.	Box
0523002	Jiffy Joint	PVC	1	24
0523030	Jiffy Joint	S.S.	1	24
0523031	Solvent	S.S.	1	24

STRAINERS & DRAINS



**PVC
TWO-PIECE
SHOWER STALL DRAINS**

W-R#	Description	Min.	Box
0523040	2" Sch.40	1	12

- Connection: 2"
- Grid Diameter: 4 1/4"
- Height: 3"



**PVC
GENERAL PURPOSE
DRAINS**

W-R#	Description	Min.	Box
0523050	2" Sch. 40	1	12
0523052	3" Sch. 40	1	12

- 0523050: 4 1/4"OD x 2" H
- 0523052: 5 3/16"OD x 2 1/4" H



**2" PVC PAN LINER
DRAIN WITH
CP BRASS STRAINER**

W-R#	Description	Min.	Box
0523014	4" Round	1	12
0523016	4" Square	1	12



- Gray PVC receptor & clamping ring



**2" PVC PAN LINER
DRAIN WITH
S.S STRAINER**

W-R#	Description	Min.	Box
0523000	2" Solvent	1	12



**2" PVC PAN LINER
DRAIN WITH
S.S STRAINER
- LOW PROFILE -**

W-R#	Description	Min.	Box
0523007	2" Solvent	1	12



**2" NO-HUB CAST IRON
SHOWER DRAIN WITH
CP BRASS STRAINER**

W-R#	Description	Min.	Box
0523012	4" Round	1	8
0523018	4" Square	1	8



**2" NO-HUB CAST IRON
- SIDE OUTLET -
SHOWER DRAIN WITH
CP BRASS STRAINER**

W-R#	Description	Min.	Box
0523102	4" Round	1	4
0523104	4" Square	1	4



STRAINERS & DRAINS



**HEAVY CP BRASS
SHOWER STRAINER
GRID**



W-R#	Description	Min.	Box
0523022	CP Brass	1	12
0523024	CP Square	1	12



**REPLACEMENT SNAP-
IN GRID FOR SHOWER
DRAINS**

W-R#	Description	Min.	Box
0523032	Stainless Steel - 4" OD	1	12



**JIFFY JOINT FOR
SHOWER DRAINS**

W-R#	Description	Min.	Box
0523010	2" IPS	1	12



**STAINLESS STEEL
FLOOR DRAIN COVERS**

W-R#	Description	Min.	Box
0541002	2" Floor Drain	1	12
0541004	3" Floor Drain	1	12
0541006	4" Floor Drain	1	12



**GALVANIZED STEEL
CESSPOOL PLATES**

W-R#	Description	Min.	Box
2210006	6" x 6"	1	10
2210008	8" x 8"	1	10
2210010	10" x 10"	1	10
2210012	12" x 12"	1	10



**GALVANIZED
FLOODSTOPPER**

W-R#	Description	Min.	Box
2535004	3" Floor Drain	1	12
2535006	4" Floor Drain	1	12

WASTES & DRAINS



**BRASS
SWIVEL TRAPS
L.A. PATTERN**

W-R#	Size	Finish	Cleanout?
1212002	1 1/2" x 1 1/4"	RB	Less C/O
1212004	1 1/2" x 1 1/4"	RB	With C/O
1212010	2" x 1 1/2"	RB	With C/O
1212000	1 1/2"	RB Sweat	Less C/O
1212006	1 1/2" x 1 1/4"	CP	Less C/O
1212008	1 1/2" x 1 1/4"	CP	With C/O



**N.Y. REGULATION
TRAP**

W-R#	Size	Finish	Cleanout?
1214004	1 1/2"	CP	With C/O
1214006	2 x 1 1/2"	RB	With C/O



**BRASS TRAP
CLEANOUT PLUG**

W-R#	Size	Finish	Min	Box
1217006	1 1/4"	CP	1	12

- Fits most cast brass LA & NY regulation traps



**BRASS TUBULAR
"P" TRAPS**

W-R#	Size	Finish	Cleanout?
1205006	1 1/4"	CP	Less C/O
1205012	1 1/2"	CP	Less C/O
1206008	1 1/2"	CP	With C/O
1205013	1 1/2" 17g	CP	Less C/O

Traps less cleanout: 22 ga
Traps with cleanout: 20 ga



**MILWAUKEE UTILITY
TRAP**

W-R#	Size	Finish	Cleanout?
1201004	1 1/2"	CP	Less C/O

- 20 gauge

WASTES & DRAINS



**BRASS TUBULAR
"S" TRAP**

W-R#	Size	Finish	Cleanout?
1203002	1 1/4"	CP	Less C/O
1203010	1 1/2"	CP	Less C/O

- 22 gauge

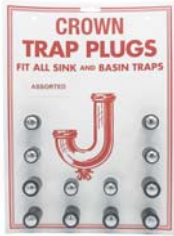

**"CROWN" RUBBER
TRAP PLUG**



Carded#	Bulk#	Description	Size
1218002	--	Assorted	
1218004	1218010	Small	3/4"
1218006	1218012	Large	7/8"
1218008	1218014	Jumbo	1 1/16"



**WASTE BENDS
-SLIP JOINT-
22 GAUGE**

W-R#	Size	Finish	Min	Box
0101002	1 1/2" x 6"	RB	1	25
0101004	1 1/2" x 8"	RB	1	25
0101008	1 1/2" x 12"	RB	1	25
0101048	1 1/2" x 12"	CP	1	25
0101012	1 1/2" x 18"	RB	1	25
0101016	1 1/2" x 24"	RB	1	25



**WASTE BENDS
-DIRECT CONNECTION-
22 GAUGE**

W-R#	Size	Finish	Min	Box
0102008	1 1/2" x 12"	RB	1	25
0102016	1 1/2" x 24"	RB	1	25



**FLANGED TAILPIECE
22 GAUGE**

W-R#	Size	Finish	Min	Box
0104030	1 1/2" x 8"	CP	1	25
0104010	1 1/2" x 12"	RB	1	25
0104034	1 1/2" x 12"	CP	1	25
0104012	1 1/2" x 18"	RB	1	25

WASTES & DRAINS



**SLIP-JOINT
EXTENSION TUBE
22 GAUGE**

W-R#	Size	Finish	Min	Box
0108018	1 1/4" x 6"	CP	1	25
0108020	1 1/4" x 8"	CP	1	25
0108024	1 1/4" x 12"	CP	1	25
0108032	1 1/2" x 12"	CP	1	25
0108016	1 1/2" x 12"	RB	1	25



**THREADED TUBES
(T.B.E.'S)**

W-R#	Size	Finish	Gauge
0109030	1 1/4" x 8"	CP	20
0109008	1 1/4" x 12"	RB	20
0109034	1 1/4" x 12"	CP	20
0109054	1 1/4" x 12"	CP	17
0109044	1 3/8" x 12"	CP	20
0109016	1 1/2" x 12"	RB	20
0109042	1 1/2" x 12"	CP	20



**8" REDUCING
TAILPIECE**

W-R#	Size	Finish	Gauge
0106002	1 1/2" Fine x 1 1/4"	CP	17



**PLUMBEREX®
ADA-APPROVED
UNDERSINK
PROTECTIVE COVERS**



Easy to install Velcro closure

W-R#	Description	Min	Box
1863002	White Trap Gear	1	6

- "Trap Gear" set includes covers for trap, 2 stops, and 2 risers.
- Vinyl cover insulates P-trap & risers to make existing installation ADA compliant.

WASTES & DRAINS



**LONG-SWEEP
DISHWASHER
TAILPIECE**

W-R#	Size	Finish	Min	Box
0117022	1 1/2" x 8"	RB	1	25
0117024	1 1/2" x 10"	RB	1	25
0117026	1 1/2" x 12"	RB	1	25

- 22 gauge



**HEAVY-DUTY
3-PIECE DISHWASHER
TAILPIECE**

W-R#	Size	Finish	Min	Box
0117050	1 1/2" x 12"	RB	1	25

- 3 piece design
- Brass slipnut
- 1/2" CTS inside, 3/4" CTS outside connection



**CAST BRASS WASHING
MACHINE TEE
- SLIP JT. -**

W-R#	Side Outlet	Min	Box
1512002	3/4" MIP x 1/2" FIP	1	10
1512004	3/4" MH x 1/2" SWT	1	10



**CAST BRASS WASHING
MACHINE TEE
- THREADED -**

W-R#	Size	Finish	Min	Box
1511002	3/4" MIP x 1/2" FIP	1	10	
1511004	3/4" MH x 1/2" SWT	1	10	



DOUBLE OFFSET

W-R#	Size	Finish	Min	Box
0115002	1 1/4"	RB	1	25
0115006	1 1/4"	CP	1	25
0115004	1 1/2"	RB	1	25
0115008	1 1/2"	CP	1	25

- 22 gauge



SINK FUNNEL

W-R#	Size	Finish	Min	Box
0110004	1 1/2" x 8"	RB	1	25



**CAST IRON
SINK COLLARS**

W-R#	Description	Min.	Box
0509500	2"ID	1	12

- 3 1/2" between centers

WASTES & DRAINS



**CHROME-PLATED
SLIP-JOINT ELBOW**

W-R#	Size	Finish	Min	Box
0112024	1 1/4" x 6"	CP	1	12
0112026	1 1/4" x 8"	CP	1	12
0112030	1 1/4" x 12"	CP	1	12

- 22 gauge



TANK ELBOW

W-R#	Size (A-B-C)	Finish	Min	Box
0113002	2" x 4" x 6"	CP	1	6
0113004	2" x 5" x 7"	CP	1	6
0113006	2" x 6" x 8"	CP	1	6

- 22 gauge



**FLANGED
COVER TUBE**

W-R#	Size	Finish	Min	Box
0116002	2"OD x 6"	CP	1	25

- Fit over 1 1/2" IPS Pipe for use as a bell escutcheon
- 22 gauge



**DOUBLE SLIP
COUPLING**

W-R#	Size	Finish	Min	Box
1501002	1 1/4"	CP	1	6
1501004	1 1/2"	CP	1	6



**DOUBLE SLIP
90° ELBOW**

W-R#	Size	Finish	Min	Box
1502002	1 1/4"	CP	1	6
1502004	1 1/2"	CP	1	6
1502008	1 1/2"	RB	1	6



**DOUBLE SLIP
45° ELBOW**

W-R#	Size	Finish	Min	Box
1506002	1 1/4"	CP	1	6
1506004	1 1/2"	CP	1	6



SLIP TEE

W-R#	Size	Finish	Min	Box
1504004	1 1/2"	CP	1	6
1504008	1 1/2"	RB	1	6

WASTES & DRAINS



TEE AND TAILPIECE

W-R#	Size	Finish	Min	Box
1508002	1 1/2"	RB	1	6



TWIN ELBOW

W-R#	Size	Finish	Min	Box
1509002	1 1/2"	RB	1	6



**GROUND JOINT CONNECTIONS
(DESANCO FITTINGS)
(TRAP ADAPTERS)**

W-R#	Size	Box
1510004	1 1/4"OD x 1 1/4" Male	25
1510006	1 1/4"OD x 1 1/2" Male	25
1510002	1 1/2"OD x 1 1/2" Male	25
1510000	1 1/2"OD x 1 1/2" Male x Swt	25



1510008	1 1/4"OD x 1 1/4" Female	25
1510009	1 1/4"OD x 1 1/2" Female	25
1510010	1 1/2"OD x 1 1/2" Female	25

- Furnished with nylon slip joint washers



COPPER x MALE TRAP ADAPTER

W-R#	Size	Box
2104006	1 1/2" Sweat x 1 1/2" MIP	25

- For 1 1/2" Copper Pipe



BLANK CAPS

W-R#	Size	Finish	Min	Box
0914002	1 1/2"	CP	10	10

WASTES & DRAINS



Zinc Die-Cast

DIE-CAST SLIPNUTS

Size	Brass-plated	Chrome-plated	Box
1 1/4" x 1 1/4"	0901002	0902002	25
1 1/2" x 1 1/2"	0901004	0902004	25
1 1/2" x 1 1/4"	0901006	0902006	25
1 1/2" x 1 3/8"	0901008	0902008	25
2" x 2"	0901010	0902010	10
2" x 1 1/2"	-	0902012	10



Solid Brass

SOLID-BRASS SLIPNUTS



0903007
Extra-Heavy

Size	Rough Brass	Chrome-Plated	Box
1 1/4" x 1 1/4"	0903002	0904002	25
1 1/2" x 1 1/2"	0903004	0904004	25
1 1/2" Heavy	0903007	-	25
1 1/2" x 1 1/4"	0903006	0904006	25
1 1/2" x 1 3/8"	0903010	0904010	10
2" x 2"	0903008	0904008	10



1 1/2" PVC SLIPNUT

W-R#	Size	Min	Box
1109506	1 1/4" PVC	25	25
1109508	1 1/2" PVC	25	25



TWO-PIECE PVC SLIPNUTS

W-R#	Size	Min	Box
0905002	1 1/4"	1	1
0905004	1 1/2"	1	1

- Replace broken slipnuts quickly and easily.



1 1/2" PVC P-TRAP WITH ADAPTER

W-R#	Size	Min	Box
1101002	1 1/2" P-Trap	1	25



PVC P-TRAPS LESS ADAPTER

W-R#	Size	Min	Box
1101004	1 1/4" P-Trap	1	25
1101003	1 1/2" P-Trap	1	25



PVC S-TRAPS

W-R#	Size	Min	Box
1104004	1 1/4" S-Trap	1	12
1104002	1 1/2" S-trap	1	12

WASTES & DRAINS



**1 1/2" X 16" PVC
END-OUTLET WASTES**

W-R#	Size	Min	Box
1105002	Slip Joint	1	12



**1 1/2" X 16" PVC
CENTER-OUTLET
WASTES**

W-R#	Size	Min	Box
1105006	Slip Joint	1	12



**1 1/2" X 15"
PVC WASTE ARMS**

W-R#	Size	Min	Box
1108005	Slip Joint	1	25
1108006	Direct Connect	1	25



1 1/2" PVC OFFSET

W-R#	Size	Min	Box
1108202	Offset	1	25



**1 1/2" PVC SLIP
ELBOWS**

W-R#	Size	Min	Box
1109002	90° Elbow	1	25
1109004	45° Elbow	1	25



**1 1/2" PVC SLIP
COUPLING**

W-R#	Size	Min	Box
1109006	Coupling	1	25



1 1/2" PVC SLIP TEE

W-R#	Size	Min	Box
1109008	Tee	1	25

WASTES & DRAINS



1 1/2" PVC FLANGED TAILPIECES

W-R#	Size	Min	Box
1110010	12"	1	25
1110012	16" Double End	1	25



1 1/2" PVC SLIP EXTENSION TUBE

W-R#	Size	Min	Box
1114006	12"	1	25
1114014	16" Double End	1	25



1 1/2" X 8" PVC BRANCH TAILPIECES

W-R#	Size	Outlet	Min	Box
1116004	Slip Joint		1/2	25
1116006	Direct Connect		1/2	25



FLEXIBLE TAILPIECES

W-R#	Size	Min	Box
1661002	1 1/4" Slip	1	25
1661000	1 1/2" Slip	1	25
1661004	1 1/2" Direct Connect	1	25

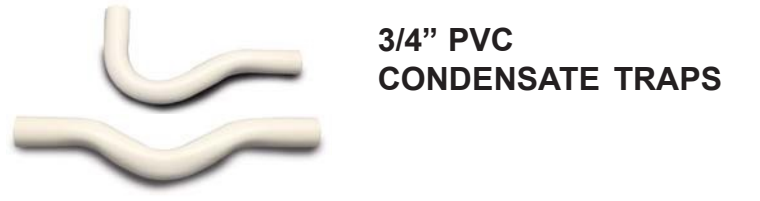

3/4" PVC CONDENSATE TRAPS

W-R#	Size	Min	Box
1207002	P-Trap	1	12
1207004	Running Trap	1	12



E-Z TRAP® CLEAR CONDENSATE TRAPS

W-R#	Size	Min
1207052	3/4" EZTrap EZT-113	1
1207090	Brush for EZ EZT-406	1

- EZ Traps' clear tubing allows for visual inspection & easy cleaning of condensate trap.



PVC SADDLES

W-R#	Size	Min
0422302	3" X 2" Less Gasket	1
0422304	4" X 2" Less Gasket	1
0422306	4" X 3" Less Gasket	1
0422308	4" X 4" Less Gasket	1

WASTES & DRAINS



**CAST IRON
PUSH-ON CLEANOUTS
-SERVICE WEIGHT**

W-R# Description

- 2423102** 3" SV with Raised Head Plug
- 2423104** 4" SV with Raised Head Plug
- 2423106** 6" SV with Raised Head Plug

- 2423302** 3" SV with **Countersunk** Plug
- 2423304** 4" SV with **Countersunk** Plug
- 2423306** 6" SV with **Countersunk** Plug



- Cleanouts are furnished less gasket



**CAST IRON
PUSH-ON CLEANOUTS
-SCH 40 STEEL**

W-R# Description

- 2423504** 4" SCH40 with Raised Head Plug

- 2423604** 4" SCH40 with **Countersunk** Plug



- Cleanouts are furnished less gasket



**CAST IRON
PUSH-ON CLEANOUTS
- NO-HUB**

W-R# Description

- 2423902** 3" No-Hub with Raised Head Plug
- 2423904** 4" No-Hub with Raised Head Plug
- 2423906** 6" No-Hub with Raised Head Plug



- Cleanouts are furnished less gasket



**CAST IRON
PLAIN-END
LONG PATTERN
CLEANOUT**

W-R# Description

- 2423704** 4" Plain End with Raised Head Plug



- Cleanouts are furnished less gasket



**CAST IRON
"DANDY" TEST TEE
- NO-HUB**

W-R# Description

- 0520002** 2" No-Hub Dandy Tee w/Plug
- 0520004** 3" No-Hub Dandy Tee w/Plug
- 0520006** 4" No-Hub Dandy Tee w/Plug



**CAST IRON
BACKWATER VALVE
- NO-HUB**

W-R# Description

- 0414906** 4" No-Hub Backwater Valve



- Removable Brass Flapper

WASTES & DRAINS

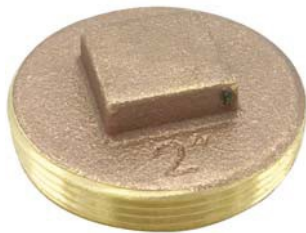

**SOUTHERN CODE
BRASS CLEANOUT
PLUGS - RAISED HEAD**



W-R#	Size	Min	Box
2424200	1 1/2" RH	1	12
2424202	2" RH	1	12
2424204	2 1/2" RH	1	12
2424206	3" RH	1	12
2424208	3 1/2" RH	1	12
2424210	4" RH	1	12
2424212	5" RH	1	12
2424214	6" RH	1	12
2424216	8" RH	1	12
2424218	10" RH	1	12



**SOUTHERN CODE
BRASS CLEANOUT
PLUGS
- COUNTERSUNK -**



W-R#	Size	Min	Box
2424300	1 1/2" CS	1	12
2424302	2" CS	1	12
2424304	2 1/2" CS	1	12
2424306	3" CS	1	12
2424308	3 1/2" CS	1	12
2424310	4" CS	1	12
2424312	5" CS	1	12
2424314	6" CS	1	12
2424316	8" CS	1	12

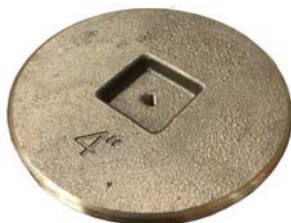

**SOUTHERN CODE
BRASS CLEANOUT
PLUGS
- COUNTERSUNK -
- WITH TAP -**



W-R#	Size	Min	Box
2425300	1 1/2" CS-Tap	1	12
2425302	2" CS-Tap	1	12
2425304	2 1/2" CS-Tap	1	12
2425306	3" CS-Tap	1	12
2425308	3 1/2" CS-Tap	1	12
2425310	4" CS-Tap	1	12



**COUNTERSUNK PVC
CLEANOUT PLUGS**

W-R#	Size	Min	Box
2424802	2"	1	12
2424804	2 1/2"	1	12
2424806	3"	1	12
2424808	3 1/2"	1	12
2424810	4"	1	12



**COUNTERSUNK PVC
CLEANOUT PLUGS
WITH BRASS INSERT**



W-R#	Size	Min	Box
2425102	2"	1	12
2425104	2 1/2"	1	12
2425106	3"	1	12
2425108	3 1/2"	1	12
2425110	4"	1	12

WASTES & DRAINS



LEAD FITALL PLUG

W-R#	Size	Min	Box
2424002	2"	1	24
2424004	2½"	1	24
2424006	3"	1	24
2424008	3½"	1	24
2424010	4"	1	24
2424012	4½"	1	24
2424014	5"	1	24
2424016	5½"	1	24
2424018	6"	1	24



ECONO RUBBER TEST PLUGS

W-R#	Size	Min	Box
1837220	1½"	1	25
1837222	2"	1	25
1837224	3"	1	25
1837226	4"	1	25
1837228	6"	1	25



ECONO RUBBER TEST CAPS

W-R#	Size	Min	Box
1837502	1½"	1	25
1837504	2"	1	25
1837506	3"	1	25
1837508	4"	1	25



Unique flanged design

RED-RUBBER TEST PLUG

W-R#	Size	Min	Box
1837200	1½"	1	25
1837202	2"	1	25
1837204	3"	1	25
1837206	4"	1	25



RED-RUBBER TEST CAP

W-R#	Size	Min	Box
1837400	1½"	1	25
1837402	2"	1	25
1837404	3"	1	25
1837406	4"	1	25

WASTES & DRAINS



**STAINLESS STEEL
EXTENSION COVER
PLATES**

**4" EXTENSION COVER
SCREW**

W-R#	Size	Min	Box
2424404	4" with screw	1	12
2424406	5" with screw	1	12
2424408	6" with screw	1	12
2424410	8" with screw	1	1
2424502	4" Screw only	12	12



**CHROME-PLATED
BRASS TRAP COVERS**

W-R#	Size	Min	Box
2211004	5¾" Raised	1	12
2211002	5¾" Flat	1	12



**CHROME-PLATED
ABS TRAP COVERS**



W-R#	Size	Min	Box
2424602	4" Flat	1	12
2424604	5" Flat	1	12
2424606	7" Flat	1	12
2424622	4" Raised (Bell)	1	12
2424624	5" Raised (Bell)	1	12
2424626	7" Raised (Bell)	1	12



**WHITE
ABS TRAP COVERS**



W-R#	Size	Min	Box
2424650	4" Flat	1	12
2424652	5" Flat	1	12
2424654	7" Flat	1	12
2424670	4" Raised (Bell)	1	12
2424672	5" Raised (Bell)	1	12
2424674	7" Raised (Bell)	1	12



**"POPPY"
SEWER RELIEF PLUG**



W-R#	Size	Min	Box
2425010	"Poppy" Sewer Relief Valve	1	12

- Reduce costly damage from a sewer back-up.
- Effective pop up design opens to relieve pressure from sewage back-up.
- Fits 3" ad 4" cleanouts

WASTES & DRAINS



PVC KNOCK-OUT TEST CAPS

W-R#	Size	Min	Box
1836002	1 1/2"	10	10
1836004	2"	10	10
1836006	3"	10	10
1836008	4"	10	10



PVC DUAL-FIT TEST CAPS

W-R#	Size	Min	Box
1836202	1 1/2" X 2"	1	6
1836204	3" X 4"	1	6

- Dual-Fit test caps reduce inventory SKU's by providing two caps in one!



PVC TERMINATION SCREEN

W-R#	Description	Min.	Box
2202010	2" Screen	1	12
2202012	3" Screen	1	12
2202014	4" Screen	1	12



FRESH AIR PLATE

W-R#	Description	Min.	Box
2202002	7" Diameter	6	6

- Galvanized Steel



CLAMP FOR FRESH AIR PLATE

2203004	Spring clamp	1	6
---------	--------------	---	---



INSIDE CAULK PITTSBURGH PATTERN BELL TRAP



W-R#	Description	Min.	Box
0524010	9" X 9"	1	1
0524012	Replacement Strainer Only	1	1



INSIDE CAULK PHILADELPHIA VENT BOX



W-R#	Description	Min.	Box
0524020	4" Vent Box	1	1
0524022	Replacement Strainer Only	1	1



3" X 4" CAST IRON AIR VENT CAP



W-R#	Description	Min.	Box
1747002	Vent Cap	1	1

WASTES & DRAINS

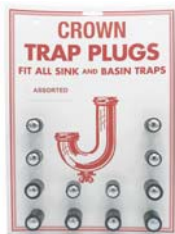

“CROWN” RUBBER TRAP PLUG



Carded#	Bulk#	Description	Size
1218002	--	Assorted	
1218004	1218010	Small	3/4"
1218006	1218012	Large	7/8"
1218008	1218014	Jumbo	1 1/16"



CAST IRON WING NUT TEST PLUG

W-R#	Size	Min	Box
1837002	2"	1	10
1837004	3"	1	10
1837006	4"	1	6
1837008	5"	1	4
1837010	6"	1	2



INFLATABLE TEST BALLS

W-R#	Size	Min	Box
1833004	2"	1	6
1833006	3"	1	4
1833008	4"	1	2

Max. Air Pressure: 13 psi
 Max. Water Pressure: 30 ft



PNEUMATIC TEST PLUGS

W-R#	Size	Water Head	Min	Box
1832002	2"	30 Feet	1	6
1832004	3"	30 Feet	1	4
1832006	4"	30 Feet	1	2

- Pneumatic Plug threads into test tee to prevent spillage or loss of plug.



GAS PROVING PUMP

W-R#	Size	Min	Box
1838002	60 psi	1	12



PUMP EXTENSION HOSES

W-R#	Size	Min	Box
1838502	2 ft	1	6
1838504	3 ft	1	6

WAL-RICH SHOWER PAN LINER

Wal-Rich Shower Pan Liner is a blue **40-mil PVC sheet membrane** used in concealed waterproofing applications.

Its primary use is in tile shower installation, and may also be used to waterproof decks, steam rooms, gang showers, reflecting pools, and fountains. Its flexibility and ease of use makes it a great alternative to sheet lead and copper.



Wal-Rich Shower Pan Liner exceeds the standards established in **ASTM D4551-01** for Vinyl Pan Liners and is IAPMO-approved.

Available in 4', 5', and 6' widths, and 40 foot and 100 foot lengths.

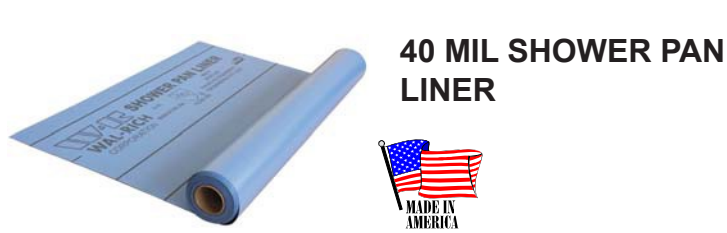

40 MIL SHOWER PAN LINER



W-R#	Size	Sq.Ft.	Weight
1920008	4' x 40'	160	45 lbs.
1920010	5' x 40'	200	60 lbs.
1920012	6' x 40'	240	70 lbs.
1920014	4' x 100'	400	128 lbs.
1920016	5' x 100'	500	155 lbs.
1920018	6' x 100'	600	175 lbs.

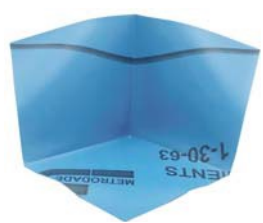

PREFAB PAN-LINER CORNERS

W-R#	Description	Min
1920050	Inside Corner	1



WAL-RICH SHOWER PAN LINER CEMENT

W-R#	Size	Min	Box
1013012	1 pt.	1	12

- Medium bodied cement used exclusively on PVC-based shower pan liners.

**WAL-RICH SHOWER PAN LINER
INSTALLATION GUIDELINES**

PREPARATION

The structural subfloor must be clean, reasonably smooth, and free of holes, cracks and sharp projections. Nail heads should be driven flush or recessed.

Blocking between studs is recommended to support the upturned shower pan liner.

Subfloor or substrate should be sloped per code requirements, towards the drain, and must contain no depressions where water will accumulate. On smaller areas, pitching may not be a code requirement. We recommend a pitched subfloor whenever possible.

Drains must be suitably designed for use with a flexible membrane. They must incorporate a clamping device and weep holes.

MATERIALS

W-R Shower Pan Liner.

W-R Shower Pan Liner Cement. Alternatively, certain other medium bodied PVC shower pan liner cements may be used, such as IPS Weld-On. Regular PVC pipe cement cannot be used with our liner, nor can products designed for CPE based material such as Noble companies Chloraloy®.

Wide head nails for tacking upturn of liner.

INSTALLATION

Line the area with W-R Shower Pan Liner. Allow for 3" upturn when cutting the liner.

Turn the liner up on all sides, fold and glue the corners.

Secure the liner to side walls using nails or staples 1/2" from the top. Lay excess material over the dam, if any, and fasten on the outside face.

The drain is fitted by pressing firmly on the liner to show the outline of the drain body opening. Cut opening, taking care not to cut beyond the perimeter of the clamping ring of the drain. Notch material to expose the tappings in the drain body, or punch out bolt holes by placing the round end of a ball pean hammer over the holes and tapping until the bolt hole has been cut.

Caulk sealant may optionally be used to improve the seal between the clamping ring and the liner. Be sure not to block weep holes with any sealants.

Fit and tighten clamping ring firmly to create a watertight seal.

Where large areas are to be protected, (steam rooms, gang showers, etc.), sheets may be joined. W-R Shower Pan Liner Cement provides a watertight, permanent seam. Allow for a 3" lap seam, and 6" when using a cap seam. Roughen both surfaces with a clean wire brush, working 3 feet at a time. Allow to cure for 24 hours before stressing.

Test installation by filling shower pan with water. If leaking is detected, first retighten the drain clamping ring. Inspect the ring to be certain that it is not warped and that it mates properly with drain body. In some cases it is possible to create a glue seal by gluing a second layer of W-R Shower Pan Liner around the drain body and reassembling the drain.

LIMITATIONS

W-R Shower Pan Liner is intended for installation with a full mortar bed. Thin bed tile installations may require a different installation.

Our installation guidelines are general descriptions and are based on information which we believe to be reliable. Because specific use, installation and material cannot be controlled by Wal-Rich Corporation, our warranty is limited to the replacement of defective product.

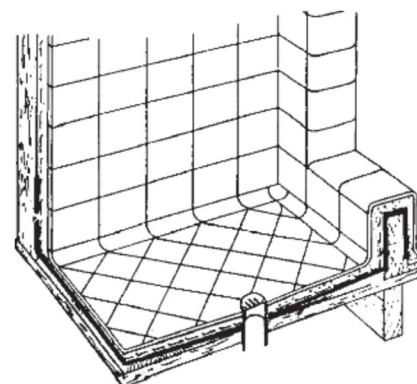
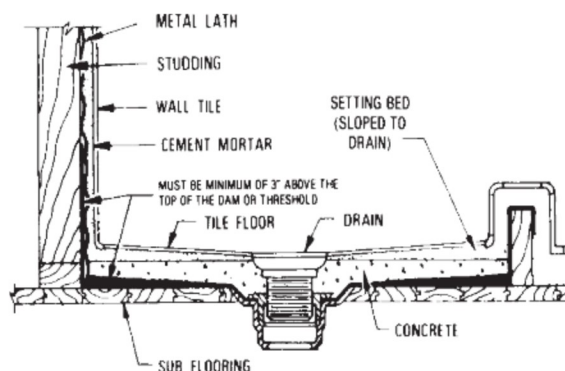

TUB & SHOWER SPECIALTIES



**CHROME-PLATED
OVERRIM SPOUT**

W-R#	Size	Length	Min	Box
0620002	1/2" FIP	5"	1	25
0620007	1/2" FIP	7"	1	25

- Zinc Die Cast



**CHROME-PLATED
DIVERTER SPOUT**

W-R#	Size	Material	Min	Box
0620004	1/2-3/4"	Die Cast	1	25
0620005	1/2-3/4"	Hvy Brass	1	25

- Furnished with 1/2"-3/4" face bushing (back mount)



**CHROME-PLATED
FRONT CONNECTION
DIVERTER SPOUT**

W-R#	Size	Length	Min	Box
0620008	1/2"	5"	1	25
0620009	1/2"	7"	1	25



**CHROME-PLATED
SLIP-ON SPOUT**

W-R#	Size	Type	Min	Box
0620001	Overrim		1	25
0620003	Diverter		1	25

- Slip on spout fits 1/2" copper with set screw and O-Ring seal



**BRASS TWIN ELBOW
FOR DIVERTER SPOUT**

W-R#	Description	Min	Box
0621002	3/4" FIP x 1/2" FIP	1	12



**CHROME-PLATED
SPOUTS FOR
PERSONAL SHOWERS**

W-R#	Description	Min	Box
0604012	1/2" MIP Side Connection	1	12



**SPOUTS FOR
"ADD-A-SHOWERS"**

W-R#	Description	Min	Box
0614010	3/8" Top Outlet	1	12

TUB & SHOWER SPECIALTIES



PERSONAL SHOWER

W-R#	Description	Min	Box
0615002	Personal Shower	1	10

- Contains:
 - Hand-held unit with shutoff lever
 - 59" hose
 - Plastic wall bracket



CHROME-PLATED HOSE FOR PERSONAL SHOWER

W-R#	Size	Min	Box
0615004	59"	1	10

- Corrugated metal hose.



CHROME-PLATED #0 BATHCOCK

W-R#	Description	Min	Box
0705002	#0 Bathcock	1	10

- 3 3/8" Center



CP BRASS HEAVY-DUTY BATHCOCK FOR "ADD-A-SHOWER"

W-R#	Description	Min	Box
0614005	Bathcock	1	24
A000217	Replacement Handles & Stems	1	12

- Heavy-duty brass construction
- 3 3/8" center-to-center
- Chrome-plated die-cast metal spout



CP BRASS "CODE" BATHCOCK FOR "ADD-A-SHOWER"

W-R#	Description	Min	Box
0614014	Code Bathcock	1	10

- 3 3/8" Center
- 3/8" top outlet
- Spout elevated above rim to comply with local codes.



CHROME-PLATED BATHCOCK COUPLING

W-R#	Description	Min	Box
0625002	Coupling	1pr.	6 pr.

- 1/2" MIP x 3/4" FIP Swivel



CHROME-PLATED OFFSET BATH SUPPLIES

W-R#	Description	Min	Box
0219002	CP Bath Supplies	1pr.	6 pr.

- 1/2" OD x 21 1/2" long
- With bell flanges

TUB & SHOWER SPECIALTIES

**“ADD-A-SHOWERS”
WITH
RECTANGULAR RING**



W-R#	Type	Aluminum Ring
0614004	W/Bathcock	24" x 42"
0614009	W/Code Bathcock	24" x 42"

Components:

- 0614005 Heavy CP Brass Bathcock or
- 0614014 CP Brass Code Bathcock
- 0614020 CP 57" Riser
- 0608014 Plastic shower head
- A000182 3/4" x 24" x 42" **aluminum** ring
- A000176 CP ring/riser bracket
- 0605013 3/4" Loop & flange kit
- 0605012 Standard loop & flange kit
- 0605002 6" support rod
- 0605006 24" support rod

**“ADD-A-SHOWERS”
- LESS RING -**



0614002

W-R#	Type	No Ring
0614002	With Heavy Duty Bathcock	
0614008	With Diverter Spout	
0614011	With Code Bathcock	

**“ADD-A-SHOWERS”
WITH ALUMINUM
D-SHAPED RING**



W-R#	Type	Aluminum Ring
0614050	With Bathcock	4 1/2' D
0614055	With Bathcock	5' D

0614057	W/Code Bathcock	4 1/2' D
0614059	W/Code Bathcock	5' D

- Aluminum tubing
- Support rods are 36" universal-fit.

TUB & SHOWER SPECIALTIES



**CHROME-PLATED
SOLID BRASS DELUXE
SHOWER HEAD**

W-R#	Size	GPM	Min	Box
0608018	1 ³ / ₄ "	2.5	1	10
0608020	2 ¹ / ₄ "	2.5	1	10
0608021	3"	2.5	1	6



**CHROME-PLATED
MASSAGE SHOWER
HEAD**

W-R#	Description	Min	Box
0608028	Massage Head	1	12

- 1/2" connection
- 2.5 GPM



**CHROME-PLATED
HAND HELD MASSAGE
SHOWER UNIT**

W-R#	Description	Min	Box
0608030	Handheld Unit	1	10

- Furnished with hose and wall bracket

0608031	Washer only	25	25
----------------	-------------	----	----



**CHROME-PLATED
DIE CAST ADJUSTABLE
SHOWER HEAD**

W-R#	Description	Min	Box
0608010	2" Adjustable	1	12



**CHROME-PLATED
DIE CAST "STAR"
SHOWER HEAD**

W-R#	Description	Min	Box
0608016	2" Star	1	25

- 2.5 GPM
- White plastic removable face



**CP PLASTIC
"STREAM-LINER"
SHOWER HEAD**

W-R#	Description	GPM	Min	Box
0608014	2"	2.5	1	25

- White plastic removable face

TUB & SHOWER SPECIALTIES



CHROME-PLATED BRASS "MINI" SHOWER HEADS

W-R#	Size	Min	Box
0608026	1" Mini	1	12

- 1/2" connection
- 2 GPM head with internal restrictor



CHROME-PLATED 6" "RAIN" HEAD

W-R#	Size	Min	Box
0608007	6" Rain	1	12

- Chrome-plated Die Cast Body
- Black Plastic Face



FLOW RESTRICTORS

W-R#	Finish	Box
2311502	2.5 GPM Rubber	25
2311500	2.5 GPM Plastic	25



SHOWER CONTROL VALVE

W-R#	Size	Min	Box
0609002	1/2" I.P.S.	1	12

- Chrome-plated brass
- Positive shutoff



DIVERTER VALVE FOR PERSONAL SHOWER

W-R#	Size	Min	Box
0611002	1/2"M x 1/2"F	1	6

- Chrome-plated brass



SELF-CLOSING SHOWER VALVE WITH CHAIN

W-R#	Size	Min	Box
0610002	1/2" I.P.S.	1	6

- Chrome-plated brass

TUB & SHOWER SPECIALTIES



**SHOWER ARM
ESCUTCHEONS - WITH
SET SCREW**

W-R#	Finish	Min	Box
0619002	Chrome - O/S	10	50
0619004	Chrome - N/S	10	50

- 1/2" X 2 1/2"OD
- O/S: Old Style
- N/S: New Style



**CP BRASS
SHOWER ARMS**

W-R#	Length	Finish	Angle
0618002	1/2" x 6"	Chrome	45°
0618004	1/2" x 8"	Chrome	45°
0618006	1/2" x 10"	Chrome	45°
0618008	1/2" x 12"	Chrome	45°
0618010	1/2" x 10"	Chrome	90°
0618012	1/2" x 12"	Chrome	90°



**10" 'S' LOW TO HIGH
SHOWER ARM**

W-R#	Description	Finish
0618022	'S' shower arm	Chrome

- Adds 10" to the height of the shower head



**ADJUSTABLE ANGLE
SHOWER ARM**

W-R#	Description	Finish
0618020	10" adjustable	Chrome



**CAST BRASS
DROP-EAR ELBOW
- LEAD FREE**

W-R#	Description	Min	Bag
4623002	1/2" C x 1/2" FIP Elbow LF		



4623010 1/2" PEX x 1/2" FIP Elbow LF



**FIBERGLASS
SHOWER ELBOW**

W-R#	Description
4623050	Fiberglass Shower Elbow



1/2" EZ-PLUG

W-R#	Description	Min	Box
2425004	1/2" EZ-Plug	1	12



- EZ plug is used with drop-ear elbow to serve as a test plug and stubout.

TUB & SHOWER SPECIALTIES



STRAIGHT ALUMINUM SHOWER RODS

W-R#	Size	Flanges	Min	Box
0601008	5'	- None -	12	50
0601002	5'	Stamped Steel	12	50
0601012	6'	- None -	12	50
0601006	6'	Stamped Steel	12	50



"L" - SHAPED ALUMINUM SHOWER RODS



W-R#	Size	Assembly	Min	Bundle
0602002	5'	1-piece	6	12
0602021	5'	Sectional*	1	-
0602004	5½'	1-piece	6	12
0602022	5½'	Sectional*	1	-
0602006	6'	1-piece	6	12
0602024	6'	Sectional*	1	-

* In order to ship via UPS, "L" rods must be shipped in Sectional format.

- All "L" rods are furnished with stamped flanges and support hardware



"U" - SHAPED ALUMINUM SHOWER RODS



W-R#	Size	Assembly	Min	Bundle
0602506	5'	1-piece	6	12
0602505	5'	Sectional*	1	-

* In order to ship via UPS, "U" rods must be shipped in Sectional format.

- All "U" rods are furnished with stamped flanges and support hardware



"D" - SHAPED ALUMINUM SHOWER RODS



W-R#	Size	Assembly	Min	Bundle
0602706	5'	1-piece	6	12
0602705	5'	Sectional*	1	-

* In order to ship via UPS, "D" rods must be shipped in Sectional format.

- All "U" rods are furnished with stamped flanges and support hardware

TUB & SHOWER SPECIALTIES



**CHROME-PLATED
"D" BAR LOOP**

W-R#	Description	Min	Box
0606002	D-Loop	1	12

- for 1" OD shower rod tubing



**STAMPED STEEL
SHOWER BAR FLANGE**

W-R#	Size	Min	Box
0603002	1"	1 pr.	50

- Chrome plated
- Furnished with screws



**CHROME-PLATED
ADJUSTABLE JIFFY
FLANGE**

W-R#	Description	Min	Box
0603004	Metal	1 pr.	50
0603006	Plastic	1 pr.	50

- For installing shower bars without screws. Friction caps secure holders to wall - eliminate drilling.



**CHROME-PLATED
JUMBO SHOWER BAR
FLANGE**

W-R#	Description	Min	Box
0603008	Jumbo	1 pr.	50

**CEILING SUPPORT
RODS & KITS**



Size	Complete Kit	Universal Kit
6"	0604002	-
18"	0604004	-
24"	0604006	0604502
30"	0604008	0604504
36"	0604010	0604506

- Complete Support Kits include 1" loop & flange and 1/8" nickel-plated steel TBE rod

- Universal Support Kits include 1" loop & flange and 1/8" nickel-plated steel TOE rod. 1" Loop has a set screw to allow the cutting of rod to desired length.



**CHROME-PLATED
LOOP AND FLANGE
FOR CEILING SUPPORT**

W-R#	Description	Min	Box
0605012	For 1" OD	1	25
0605013	For 3/4" OD	1	25
0605014	Universal, for 1" OD	1	25

TUB & SHOWER SPECIALTIES



SHOWER CURTAIN PINS

W-R#	Description	Min	Box
0607002	Curtain Pins	100	100



SHOWER SPLASH GUARDS

W-R#	Description	Min	Box
1691002	7" x 7"	1	12

- Pair to a bag
- Self-adhesive



CHROME-PLATED RISER TO RING BRACKET

W-R#	Description	Min	Box
0606502	3/8" to 1"	1	12

- for attaching Add-A-Shower risers to 1" shower rod



TRIP LEVER FACE PLATE ASSEMBLY

W-R#	Description	Min	Box
0626002	Chrome	1	24

- Less screws

W-R#	Description	Min	Box
0620020	Chrome	1	24
0626012	Brushed Nickel	1	12

- With screws



0531002

0626056

CHROME-PLATED BLANK FACE PLATE FOR TRIP WASTE

W-R#	Description	Min	Box
0626006	2 Hole	1	100
0626056	2 Hole with Screws	1	100

0531002	1 Hole	1	100
0531052	1 Hole with Screws	1	100



CHROME-PLATED WASTE & OVERFLOW STRAINER PLATES

W-R#	Description	Min	Box
0531000	Round	1	10

- 3 1/8" OD

TUB & SHOWER SPECIALTIES



WASTE & OVERFLOW WASHER

W-R#	Description	Min	Box
2716002	Rubber	1	25
2716001	Sponge Rubber	1	25



TUB TRIM CONVERSION KITS

W-R#	Description	Min	Box
0626025	Chrome	1	1
0626030	Brushed Nickel	1	1

Includes:

- Trip Plate Assembly
- 2 Trip Plate Screws
- Bath Shoe Grid
- 1 Bath Shoe Bolt



FACE PLATE SCREWS

W-R#	Description	Min	Box
0627002	Chrome	6	6
0627006	Pol. Brass	6	6
0627004	CP with ring	6	6

- 1 1/2" Long, 1/4" x 20T



BATH SHOE STRAINER GRID

W-R#	Description	Min	Box
1407010	Stainless Steel	1	12
1407014	C.P. Brass	1	12
1407016	Polished Brass	1	6
1407018	Brushed Nickel	1	6



BOLT FOR BATH SHOE GRIDS

W-R#	Description	Min	Box
1407020	Chrome	12	12
1407022	Polished Brass	6	6

- 1/8" x 1 3/4"



BATH SHOE FOR WASTE & OVERFLOW

W-R#	Description	Min	Box
1407002	1 3/8" OD x 6"	1	6
1407004	1 1/2" OD x 6"	1	6
1407008	1 1/2" OD x 18"	1	-



SCREW IN BATH SHOE STRAINER

W-R#	Description	Min	Box
1407006	Strainer	1	6

- Stainless steel
- 1 1/2" Diameter x 1" height



FLAT BATH SHOE WASHER

W-R#	Description	Min	Box
2716000	Black Rubber	25	25

TUB & SHOWER SPECIALTIES



FITALL SINK & TUB STOPPERS

W-R#	Description	Min	Box
1678020	1" - 1 3/8"	12	12
1678022	1 1/2" - 2"	12	12

- White molded rubber



5" WHITE VINYL FLAT STOPPER

W-R#	Description	Min	Box
1678030	5" stopper	1	6



HAIR SNARE

W-R#	Description	Min	Box
0527500	Hair Snare	6	6

- Fits most sink, wash tray, and tub drains. Keeps hair and other objects from clogging drains



NICKEL-PLATED STOPPER RINGS

W-R#	Description	Min	Box
1680002	Stopper Rings	25	100



COUPLING FOR #10 (3/16") BEAD CHAIN

W-R#	Description	Min	Box
1617002	Type A	100	100
1617004	Type B	100	100



#10 NICKEL-PLATED BRASS BEADED CHAIN

W-R#	Description	Min	Box
1616004	15" Piece	10	10
1616006	100' Roll	1	-



CONNECTED WASTE AND OVERFLOW FOR CLAWFOOT TUB

W-R#	Size	Tubular Finish	Trim
1401002	1 3/8"	RB	Chrome
1401006	1 3/8"	Chrome	Chrome

- Fits Essex-style tubs

TUB & SHOWER SPECIALTIES



**PVC TRIP WASTE
SCH40 PVC
-TOE TOUCH STYLE**

W-R#	Description	Min	Box
1404502	SCH40 Toe-Touch	1	12

- Chrome-plated two-hole plate
- Chrome-plated tip-toe drain



**PVC TRIP WASTE
STANDARD TUBULAR
- TRIP LEVER STYLE**

W-R#	Description	Min	Box
1405602	Trip Lever & Grid	1	12



**PVC TRIP WASTE
STANDARD TUBULAR
- TOE TOUCH STYLE**

W-R#	Description	Min	Box
1405604	Toe Touch	1	12



**PVC TRIP WASTE
STANDARD TUBULAR
- LIFT/TURN STYLE**

W-R#	Description	Min	Box
1405606	Lift & Turn	1	12



- Concealed Flanges

**PEENED
STAINLESS STEEL
GRAB BARS**

Size	1 1/4"	1 1/2"	Min	Box
18"	1370002	1371002	1	12
24"	1370004	1371004	1	12
30"	1370006	1371006	1	8
36"	1370008	1371008	1	8
42"	1370010	1371010	1	4
48"	1370012	1371012	1	4

- 18-gauge, T-304 stainless steel

TUB & SHOWER SPECIALTIES



TRIP-WASTE ROD & SPRING ASSEMBLY

W-R#	Description	Min	Box
1402002	Trip Rod & Spring Only	1	12
1402100	Complete Kit w/Trip Plate & Screws		

- Fits Gerber & Price Pfister Trip Wastes



GENUINE FLIP IT® CHROME-PLATED TUB DRAIN

W-R#	Description	Min	Box
1407620	For Tub	1	-

• Fits all makes of tub drains by selecting the proper O-Rings to completely seal the bath shoe.



CHROME-PLATED TIP TOE DRAIN

W-R#	Description	Min	Box
1407608	1 1/2"	1	12

- Fits Gerber bath shoes (coarse thread)

TIP-TOE CARTRIDGE

1407610	5/16" Cartridge	1	12
1407612	3/8" Cartridge	1	12



CHROME-PLATED "LIFT AND LOCK" DRAIN

W-R#	Description	Box
1407602	1 1/4" Fine Thread	12

- Fits Wal-Rich bath shoes

1407604	1 1/2" Coarse Thread	12
---------	----------------------	----

- Fits Gerber bath shoes

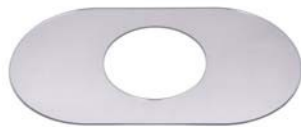

0623502



0623504



0623506

ACRYLIC TRIM PLATES ("GOOF" PLATES)

W-R#	Description	Dimension
0623502	Single Lever	8" x 14"
0623504	Two Handle	6" x 14"
0623506	Three Handle	6" x 14"
0623508	Tub Spout	3 1/2" OD

- Single Lever ID: 5"

- All other ID's: 1 3/4"

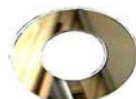

0623508

SHOWER DOOR SPECIALTIES



STAINLESS STEEL SHOWER TRIM PLATES ("GOOF PLATES")



W-R#	Description	Dimension
0623550	Single Lever	7 1/4" x 13"
0623552	Two Handle	7 1/4" x 13"
0623554	Three Handle	7 1/4" x 13"

- Single Lever ID: 5 1/8"
- All other ID's: 1 3/8"



NYLON SHOWER DOOR ROLLERS

W-R#	Size	Type	Min	Box
SDP08	3/4"	Flat	1 pr.	10
SDP12	3/4"	Round	1 pr.	10



UNIVERSAL SHOWER DOOR BRACKET & ROLLER

W-R#	Size	Type	Min	Box
0607102	Bracket		1	10

- 4 holes allow universal height adjustment



VINYL SHOWER DOOR SEAL

W-R#	Description	Min	Box
SDP04	1 1/2" x 36" 1	6	



SHOWER DOOR LATCH

W-R#	Description	Min	Box
SDP28	1" Centers	1	6

- Used for hinged shower doors



SHOWER DOOR BUMPER

W-R#	Description	Min	Box
SDP24	3/4" Bumper	4	12

- Includes screws



PLASTIC "REPLACE-A-BAR" TOWEL BARS

W-R#	Description	Min	Box
1645002	24" Clear	12	12

- Fits all standard brackets - Can be cut to size.



Made in the U.S.A.

TOILET SPECIALTIES



KORKY® FLAPPER BALLS



1330500 New Design



1330503



1330502 New Design



1330506



1330530



1330510



1330512



1330520



1330538....New!

W-R#	Description	Lavelle#	Min
1330500	Korky®	54BP	12
1330502	Korky®Plus	2001BP	12
1330503	Korky®1.6	16BP	12
1330506	Korky®Adjustable	2004BP	12
1330510	Korky® Classic	50BP	12
1330512	Korky® Classic	2000BP	12
1330516	Korky® Kohler	2010BP	12
1330518	Korky® Shark	2012BP	12
1330520	Korky® Ultra	100 BP	12
1330522	Korky® Blue Vinyl	52P	12
1330530	Korky® 3" Universal	3060BP	1
1330532	Korky® Class 5	3010BP	12
1330534	Korky® Titan	3030BP	12
1330536	Korky® Cadet 3	3040BP	12
1330538	Korky® Toto 3"	2023BP	12

KORKY® QUIETFILL BALLCOCK



Adjusts from 7" - 11"



W-R#	Description	Lavelle#	Min
1330552	Korky®Quietfill	528	1

- Universal, adjustable fit
- Easy to install
- Chlorine resistant
- Quietest fill

W-R#	Description	Lavelle#	Min
1330560	Replacement Cap	818BP	1

- Universal, adjustable fit
- Easy to install
- Chlorine resistant
- Quietest fill

TOILET SPECIALTIES



**TRIPLE-SEAL®
TANK BALLS**

W-R#	Description	Gunk#	Min
1330000	Triple Seal	B-251	1 dz.
1329500	3" Triple Seal	B-252	1 dz.



**SEALMASTER®
FLAPPERS**

W-R#	Description	Gunk#	Min
1330604	Sealmaster®	B-264V	1 dz.



**BLUE FLAPPER
TO FIT
AMERICAN STANDARD**

W-R#	Description	Min	Box
1331030	Blue Flapper	1	25
- Furnished with 9" stainless steel chain			
- Fits OEM#47146-007			



**FLAPPER WITH FLOAT
TO FIT AMERICAN
STANDARD**

W-R#	Description	Min	Box
1331016	With Float	1	25
- Black Rubber			
- Fits OEM#738159-0070A			



**FLAPPER TO FIT
AMERICAN STANDARD &
COAST 1.6**

W-R#	Description	Min	Box
1331014	With float	1	12
- Fits OEM#s: Am. Std.: 738071-0070A			
Coast: 53356			
Kohler: 81217			



**3" FLAPPER TO FIT
AMERICAN STANDARD
CADET**

W-R#	Description	Min	Box
1331018	3" with chain	1	12
- Fits OEM#s: Am. Std.: 738920-0070A			

TOILET SPECIALTIES



3" FLAPPER TO FIT GERBER AVALANCHE



W-R#	Description	Min	Box
1331062	3"	1	12

- Fits OEM#99-770



3" FLAPPERS TO FIT KOHLER

W-R#	Description	Min	Box
1331054	Fits Cimmaron	1	12
1331056	Fits Class-5	1	12



FLAPPER TO FIT KOHLER

W-R#	Description	Min	Box
1331004	Black Rubber	1	12

- Fits OEM#49114



FLAPPER TO FIT KOHLER 1.6 GPF

Styrofoam float

W-R#	Description	Min	Box
1331002	1.6 Flapper	1	12

- Black molded rubber with styrofoam ball
- Fits OEM#83064



NEW-STYLE FLAPPER TO FIT KOHLER RIALTO®

W-R#	Description	Min	Box
1331050	Fits N/S Rialto®	1	12

- Red Chemical resistant rubber
- Furnished with 9" stainless steel chain
- Fits OEM#CSP5170



NEW-STYLE FLAPPER TO FIT KOHLER AQUALINE®

W-R#	Description	Min	Box
1331052	Fits Aqualine®	1	12

- Red Chemical resistant rubber
- Furnished with 9" stainless steel chain
- Fits OEM#84314



3" FLAPPER TO FIT MANSFIELD

W-R#	Description	Min	Box
1331060	3"	1	12

- Fits OEM#630-0207

TOILET SPECIALTIES



**FLAPPER TO FIT TOTO
"POWER GRAVITY"
TOILETS**

W-R#	Description	Min.	Box
1331070	Blue Flapper	1	12
- Fits OEM#THU140S			



**FLAPPER TO FIT TOTO
"G-MAX" TOILETS**

W-R#	Description	Min.	Box
1331072	Red Flapper	1	12
- Fits OEM#THU138S			



**FLAPPER TO FIT TOTO
WITH "CLEAR-CONE"**

W-R#	Description	Min.	Box
1331074	Flapper w/ Clear Cone	1	12
- Fits OEM#THU303			



**TEAL PREMIUM SILICON
FLAPPER**

W-R#	Description	Min.	Box
1331012	Premium	1	25
- 100% silicone rubber for chlorine and abrasion resistance.			



**CLEAR VINYL FLAPPER
WITH "TIME-TIPS"**

W-R#	Description	Min.	Box
1331035	"Time Tips"	1	12
- Clear vinyl is chemically resistant			
- Furnished with 5 "time-tips" to accommodate a variety of flush rates.			



**WAL-RICH
ECONOMY FLAPPERS**

W-R#	Description	Min.	Box
1331006	Black Vinyl	1	100
1331008	Black Rubber	1	100

TOILET SPECIALTIES



**WAL-RICH
ELJER-STYLE TANK
BALLS**

W-R#	Description	Min.	Box
1330004	Fits Eljer	1 dz	-



**WAL-RICH
TRIPLEX TANK BALLS**

W-R#	Description	Min.	Box
1330006	Triplex	1 dz	-
1330008	3" Triplex	1 dz	-



LIFT WIRES

W-R#	Description	Min.	Box
1319002	8" Upper	25	25
1320002	4½" Lower	25	25
1320004	5" Lower	25	25
1320006	5½" Lower	25	25



**BRASS OVERFLOW
TUBES**

W-R#	Connection	Length	Gauge
1323002	1" x 1 1/8"	10"	22 ga
1323010	1"	10"	22 ga



DOUGLAS FLUSHVALVE

W-R#	Description	Min.	Box
1301004	Brass	1	12
1301008	Plastic with Flapper	1	50



**BEVELED FLUSHVALVE
WASHER**

W-R#	Description	Min.	Box
2718001	Sponge	12	12
2718002	Rubber	12	12

- 3" O.D. x 2 3/8" I.D. x 3/8" High

TOILET SPECIALTIES



#4 FLUSHVALVE FOR AMERICAN STANDARD

W-R#	Description	REF#
1304016	New Style #4	47107-007A
1304018	Old Style #4	47086-007A



#5 FLUSHVALVE FOR AMERICAN STANDARD

W-R#	Description	Min.	Box
1304020	#5	1	-
- Replaces American Standard #47089-07			



#4 ACTUATOR

W-R#	Description	Min.	Box
1304040	#4 Actuator only	1	-
- Replaces American Standard #147086			



#5 ACTUATOR

W-R#	Description	Min.	Box
1304042	#5 Actuator only	1	-
- Replaces American Standard #173380			



#6 ACTUATOR

W-R#	Description	Min.	Box
1304044	#6 Actuator only	1	-
- Replaces American Standard #72880.07			



CHAIN KIT TO FIT AMERICAN STANDARD FLUSHVALVES

W-R#	Description	Min.	Box
1304010	Chain Kit	6	24
1304012	Chain with Float	6	24
- Includes chain, clip & rubber grommet			
- Individually bagged			



REPLACEMENT FOR AMERICAN STANDARD SEAT DISC

W-R#	Description	Min.	Box
1361002	Screw On	1	12
1362004	Snap On	1	12
1362006	Combination Snap/Screw	1	12

TOILET SPECIALTIES



**SEAL TO FIT
AMERICAN STANDARD
"CHAMPION"**

W-R#	Description	Min.	Box
2718010	Champion (3.5" OD)		
2718012	Champion 4 (4.5" OD)		



**"FEATHER" GASKET
TO FIT
AMERICAN STANDARD**

W-R#	Description	Min.	Box
2718004	Gasket	1	24

- 2 3/8"OD x 1 5/8"ID x 3/8" High



**SEAL TO FIT
KOHLER "CLASS-5"**

W-R#	Description	Min.	Box
2718014	Class 5	1	12



210

211

**FLUSHVALVES TO FIT
MANSFIELD**

W-R#	Description	Min.	Box
1360100	Fits #210	1	12

- For 3.5 Gallon Tanks
- 10 3/4" Length

1360102	Fits #211	1	12
----------------	-----------	---	----

- For 1.6 Gallon Tanks
- 10 3/4" Length



**SEAL TO FIT
MANSFIELD 209
FLUSHVALVES**

W-R#	Description	Min.	Box
1304524	Seal	6	24

- OEM#208/209



**SEAL TO FIT
MANSFIELD 210
FLUSHVALVES**

W-R#	Description	Min.	Box
1304525	Seal	6	24

- OEM#210/211

TOILET SPECIALTIES



1304000

PLASTIC ADJUSTABLE BALLCOCKS

W-R#	Description	Min.	Box
------	-------------	------	-----

1304000 Fits Hoover A-62 1 12

- 9 1/2" - 13" Height Adjustment
- Antisiphon
- 4 Screw Cap



FILLPRO-STYLE BALLCOCK

W-R#	Description	Min.	Box
------	-------------	------	-----

1304002 1 25

- Non corrosive, no float or rod needed. Built-in filter screen saves water and replaces old fashioned ballcocks.



REPLACEMENT BALLCOCK TO FIT KOHLER RIALTO

W-R#	Description	Min.	Box
------	-------------	------	-----

1305500 Kit for Rialto 1 6

- Complete kit includes fill valve, floats, refill tubing, and caps.
- Replaces Kohler OEM# 84499



PLASTIC FLOAT

W-R#	Description	Min.	Box
------	-------------	------	-----

1332002 4" Float 1 100



BRASS BALLCOCK RODS

W-R#	Description	Min.	Box
------	-------------	------	-----

1321006 10" 1 12



BALLCOCK SHANK WASHER

W-R#	Description	Min.	Box
------	-------------	------	-----

2721002 Shank Washer 1 24

TOILET SPECIALTIES



BALLCOCK NUTS

W-R#	Description	Min.	Box
0913002	Brass Coupling	1	25
0913006	PVC Coupling	1	25



BALLCOCK TOP ASSEMBLIES

W-R#	Description	Type	Box
1304532	1B1X (Rialto)	3-screw	12
1304536	Hoovr-Line	4-screw	12



BALLCOCK PLUNGER REPAIR KITS

W-R#	Description	Screws	Box
1304506	1B1X (Rialto)	3	12
1304508	Hoovr-Line	4	12



FLUIDMASTER® BALLCOCKS

W-R#	Description	Min.	Box
1360004	#400A	1	25
1360502	#PRO45	1	25
1360504	#PRO45B	1	25



FLUIDMASTER® BETTER THAN WAX GASKET

W-R#	Description	Min
1360402	PRO7530	1

-This innovative wax-free toilet seal fits any drain, any toilet, can be repositioned during installation, and excessive plunging won't cause leaks.



TOILET SPECIALTIES



Fluidmaster.

**FLUIDMASTER®
PRO56 FLAPPER**



W-R#	Description	Min	Box
1360106	PRO56	1	20

- PRO56 Universal Adjustable Toilet Flapper is best for use in 1.28, 1.6 and 3.5 gallons per flush toilets.

- PRO56 is adjustable for optimum performance, chlorine resistant, and has a solid frame for ultimate reliability.



Fluidmaster.

**FLUIDMASTER®
PRO58 FLAPPER**



W-R#	Description	Min	Box
1360104	PRO58	1	10

- PRO58 adjusts to fit any 3" toilet on the market in just three easy adjustments.

- PRO58 is adjustable for optimum performance, chlorine resistant, and has a solid frame for ultimate reliability.



Fluidmaster.

**FLUIDMASTER® #555
FLUSHER FIXER KIT**

W-R#	Description	Min.	Box
1360006	#555	1	12

- Easy to install. Corrosion free.
- This non-corroding stainless steel seat and captive flapper gives you perfect shutoffs every time.



Fluidmaster.

**FLUIDMASTER® #242
KIT**

W-R#	Description	Min.	Box
1360008	#242 Kit	1	12

1360009	W-R Kit fits 242	1	25
----------------	-------------------------	---	----



Fluidmaster.

**FLUIDMASTER®
550 DFRK
DUO-FLUSH SYSTEM**

W-R#	Description
1360020	550DFRK Duo Flush Kit

- No tank removal, snap to fit
- Fits all brands
- Not compatible with Mansfield & 3" flush valves, ballcocks or low-boy toilets

TOILET SPECIALTIES



**CHROME-PLATED
"CROWN" TANK LEVER**

W-R#	Description	Arm	Min.	Box
1318002	Boxed	Flat	1	100
1318004	Bagged	Flat	1	100

- 8 1/4" Flat Brass Arm with score line for easy trimming to American Standard size



**CHROME-PLATED
OFFSET "CROWN"
TANK LEVER**

W-R#	Description	Arm	Min.	Box
1318015	Offset	Flat	1	25

- 8 1/4" Offset Flat Brass arm with score lines.
- Metal Spud & Nut



**CHROME-PLATED
INDEX BRASS ARM
TANK LEVER**

W-R#	Description	Arm	Min.	Box
1318000	Boxed	Round	1	100
1318001	Bagged	Round	1	100

- 8 1/4" Round Brass Arm
- Metal Spud & Nut



**"ACCENT" SINGLE
ACTION TANK LEVER**

W-R#	Description	Arm	Min	Box
1317002	Boxed	BP	1	100
1317004	Bagged	BP	1	100

1317010 With Plastic Spud & Nut 1 100

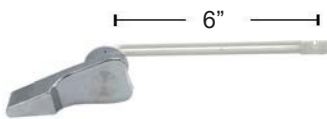

**STRAIGHT
TANK LEVERS TO FIT
AMERICAN STANDARD**

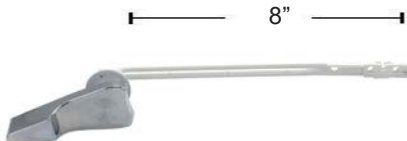

W-R#	Size	Arm	Min	Box
1318006	4" CP	ABS	1	25
1318042	6" CP	ABS	1	25
1318019	6" CP	Brass	1	25
1318028	8" CP	ABS	1	25
1318144	8" White	ABS	1	25



**ANGLE
TANK LEVERS TO FIT
AMERICAN STANDARD**



W-R#	Size/Angle/Finish	Arm	Min	Box
1318018	4" CP	Brass	1	25
1318050	6" (45°) CP	ABS	1	25
1318052	6" (28°) CP	ABS	1	25

TOILET SPECIALTIES



**CP PUSH-BUTTON
TANK LEVERS**

W-R#	Description	Min.	Box
1318008	Side Mount	1	12



1318026

**CP SIDE MOUNT
TANK LEVERS FOR
ELJER**

W-R#	Description	Min.	Box
1318026	Fits Eljer	1	25

• Brass Arm, plastic spud & nut



**“TOUCH-FLUSH” KIT TO
FIT ELJER**

W-R#	Description	Min.	Box
1331020	Touch-Flush Kit	1	50

• Includes 4 Piece flush lever, replacement tank ball, and all necessary mounting hardware



**CAST BRASS TANK
LEVER FOR KOHLER
CHAMPLAIN**

W-R#	Description	Min.	Box
1318032	Offset Lever	1	24

- Fits OEM #51394



**CAST BRASS TANK
LEVER FOR KOHLER
WELLWORTH**

W-R#	Description	Min.	Box
1318034	Cast brass lever	1	24

- Fits OEM #500189



**ABS TANK LEVER FOR
KOHLER
CIMARRON**

W-R#	Description	Min.	Box
1318038	Fits Cimarron	1	25



**CP TANK LEVER
FOR KOHLER
WELLWORTH &
BARRINGTON**

W-R#	Description	Min.	Box
1318030	ABS Lever	1	24

- For side-mount Wellworth models
- Fits OEM#30324

TOILET SPECIALTIES



CP TANK LEVER FOR MANSFIELD #42

W-R#	Description	Min.	Box
1318022	Brass Arm	1	24
1318023	Blue Plastic Arm	1	24



1318070

CP TANK LEVER TO FIT TOTO

W-R#	Description	Min.	Box
1318070	Fits THU-004 "Ultimate"	1	24
1318072	Fits THU-068 "Drake"	1	24
1318074	Fits THU-061 "Carusoe"	1	24



1318072



1318074



1318090

TANK LEVERS FOR PRESSURE ASSIST TOILETS

W-R#	Description	Fits REF#
1318090	To Fit Gerber	99-0571-KT
1318092	To Fit Am Std	738473-0020A
1318094	To Fit Am Std	738153-0020A



1318092



1318094

TOILET SPECIALTIES



TANK-TO-BOWL GASKETS

W-R#	Description	Dimensions (OD x ID xThk)
------	-------------	---------------------------

2717002	Regular	3 5/16" x 2 3/8" x 3/4"
2717004	Gerber	3 1/4" x 2 1/8" x 1 3/16"
* 2717006	Am. Std.	3 1/2" x 2 1/8" x 1 3/16"
2717007	Eljer (with ears)	
2717008	Eljer	3 1/8" x 2 1/4" x 3/8"
2717010	Kohler	4 3/16" x 2 3/8" x 3/4"
2717011	"U" Gasket	
2717013	Kohler Triangle Gasket	
* 2717014	Gerber	3 3/4" x 2 3/16" x 1 3/16"
2717020	KORKY® Universal 3"	

* Recessed Gasket

TANK-TO-BOWL BOLT & GASKET KITS



PREMIUM KITS (ALL-BRASS)

W-R#	Description	Min.	Box
------	-------------	------	-----

1359500	Universal	1	24
1359502	Gerber	1	24
1359504	Am. Std.	1	24
1359508	Mansfield	1	24
1359510	Kohler	1	24
1359514	New Style Gerber	1	24



STANDARD KITS (BRASS BOLTS/ STEEL WASHERS)

W-R#	Description	Min.	Box
------	-------------	------	-----

1359002	Universal	1	24
1359004	Gerber	1	24
1359006	Am. Std.	1	24
1359000	Kohler	1	24
1359010	Mansfield	1	24
1359012	Kohler Triangle	1	24
1359014	New Style Gerber	1	24

ECONOMY KITS (BP BOLTS/STEEL WASHERS)

W-R#	Description	Min.	Box
------	-------------	------	-----

1359520	Gerber	1	24
1359522	Am. Std.	1	24
1359524	Universal	1	24



TANK-TO-BOWL BOLTS

W-R#	Bolts/Nuts/Washers	Min.	Box
------	--------------------	------	-----

1338000	Brass/Brass/Brass	1 pr.	25
1338006	Brass/Steel/Steel	1 pr.	25
1338008	Steel/Steel/Steel	1 pr.	25

- All tank-to-bowl bolts are furnished with wing nuts, hex nuts, metal washers, and rubber washers

TOILET SPECIALTIES



1349002



1350002



1351002



1353002



1352002

BRASS CLOSET FLANGES

W-R#	Description	Min.	Box
1349002	Regular	1	50
1350002	Deep	1	50
1351002	For 3" D.W.V. copper	1	25
1352002	4 x 3 Flange for lead	1	25
1353002	Offset for 4" lead	1	25



PVC "PUSH-2-SET" CLOSET FLANGE

W-R#	Description	Min.	Box
1346090	3"	1	6
1346092	4"	1	6

- Ribbed gasket push-fits inside cast iron & PVC pipe



PVC "TWISTEE" CLOSET FLANGE

W-R#	Description	Min.	Box
1346081	3"	1	6
1346083	4"	1	6

- Twist-style gasketing expands to fit cast iron pipe.



PVC INSIDE (STREET) CLOSET FLANGES WITH SS RING

W-R#	Description	Min.	Box
1346110	3" Street x 4"	1	6
1346118	4" Street x 6"	1	6

- Inside fit design allows for easy solvent-weld installation.
- Stainless steel ring



TOILET SPECIALTIES



**CAST IRON CLOSET
FLANGES
- INSIDE CAULK**



W-R#	Description	Min	Box
1349101	4" X 1 1/2" Caulk	1	10
1349102	4" X 2" Caulk	1	8
1349103	4" X 2 1/2" Caulk	1	8
1349104	4" X 3" Caulk	1	4
1349106	4" X 4" Caulk	1	4
1349107	4" X 6" Caulk	1	2



**EXTRA-HEAVY
CAST IRON
CLOSET FLANGES
- INSIDE CAULK**



W-R#	Description	Min	Box
1349603	4" X 2 1/2" Extra-Heavy	1	8
1349604	4" X 4" Extra-Heavy	1	4
1349606	4" X 6" Extra-Heavy	1	2



**OFFSET
CAST IRON
CLOSET FLANGES
- INSIDE CAULK**



W-R#	Description	Min	Box
1349115	4" X 2" Offset	1	8
1349313	4" X 4" X 2" Offset	1	4



**REDUCING
CAST IRON
CLOSET FLANGE
- INSIDE CAULK**



W-R#	Description	Min	Box
1349702	4" X 3" x 3"	1	8



**CAST IRON
CLOSET FLANGES
- NO-HUB**



W-R#	Description	Min	Box
1349302	3" X 3" No-Hub	1	6
1349304	4" X 3" No-Hub	1	6



**OFFSET
CAST IRON
CLOSET FLANGES
- NO-HUB**



W-R#	Description	Min	Box
1349315	4" X 4" x 2" No-Hub Offset	1	4

TOILET SPECIALTIES



**CAST IRON
CLOSET FLANGES
- NO HUB QUIKSET**

W-R#	Description	Min	Box
1353006	3" X 2" Quik-Set	1	8
1353004	4" X 2" Quik-Set	1	8
1353008	4" X 3" Quik-Set	1	4
1353010	4" X 4" Quik-Set	1	4



- Stainless Steel bolts & nuts
- Ribbed neoprene gasket for greater seal
- "Push-on" style for easy installation



**OFFSET
CAST IRON
CLOSET FLANGES
- NO HUB "QUIKSET"**

W-R#	Description	Min	Box
1353015	4" Offset Quik-Set	1	4



- Stainless Steel bolts & nuts
- Ribbed neoprene gasket for greater seal



Side-view

**CAST IRON
CLOSET FLANGES
- NO-HUB "PUSH-IN"**

W-R#	Description	Min	Box
1349500	3" X 4" Push-In	1	4
1349502	4" X 2" Push-In	1	4
1349504	4" X 3" Push-In	1	4
1349506	4" X 4" Push-In	1	4



- "Push-in" style for easy installation
- Ribbed neoprene gasket for greater seal

FLANGE BOLTS & SCREWS

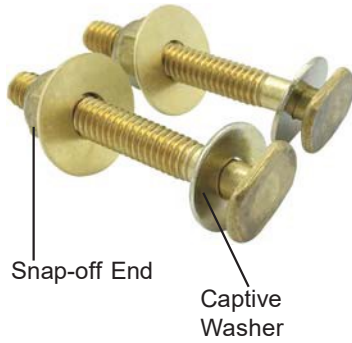

**E-Z FIX
"SNAP-OFF" STYLE
CLOSET FLANGE BOLTS
(PAIR/BAG)**

W-R#	Size	Bolt / Nut
1346504	1/4" x 2 1/4"	All-Brass
1346404	5/16" x 2 1/4"	Brass/BP
1346400	5/16" x 2 1/4"	All-Brass

- Captive Washer & Snap-off tip
- Round Washer
- 25 pairs per bag



**CLOSET FLANGE BOLTS
(PAIR/BAG)**

W-R#	Size	Bolt / Nut
1344006	1/4" x 2 1/4"	BP/BP
1344010	1/4" x 3 1/2"	BP/BP
1344012	5/16" x 2 1/4"	BP/BP
1343012	5/16" x 2 1/4"	Brass/BP
1344014	5/16" x 3 1/2"	BP/BP
1343016	5/16" x 3 1/2"	Brass/BP

- 25 pairs per bag
- Round washers & plastic retainer clips

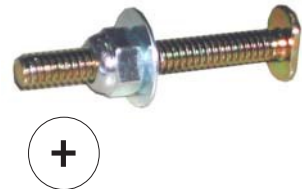

**CLOSET FLANGE BOLTS
(BULK PACKED)
(100 PER BOX)**

W-R#	Size	Bolt / Nut
1344008	1/4" x 2 1/4"	BP/BP

- Round washers & plastic retainer clips



**CLOSET FLANGE BOLTS
(DOUBLE-NUTS
& WASHERS)**

W-R#	Size	Bolt / Nut
1344002	1/4" x 2 1/4"	BP/BP
1344020	1/4" x 3 1/2"	BP/BP
1343030	1/4" x 2 1/4"	Brass/Brass
1343042	1/4" x 3 1/2"	Brass/Brass



**WALL-HUNG TOILET
CARRIER CAPS**

W-R#	Description	Min.	Box
2405002	Standard	1 pr.	12
2405003	Extra Long	1 pr.	12

- Each bag contains 4 nuts & 4 washers

TOILET SPECIALTIES



1357002



1358002
1358030



1356002

For wall-hung
toilets



1356004



1358602



1358500



1358604

CLOSET FLANGE GASKETS

W-R#	Description	Min.	Box
1357002	Wax Gasket	1	48
1358002	Deep w/Horn	1	24
1358030	4" Deep w/Horn	1	24
1356002	Sponge Rubber (5 3/8" x 3 1/2" x 3/4")	1	24
1356004	Sponge Rubber with holes (6 3/4" x 3 1/2" x 3/4")	1	24
1358602	Felt-Wax Closet	1	12
1358604	Felt-Wax Urinal	1	12
1358500	2" Wax Urinal	1	12



"CROWN-360" FLANGE REPAIR RING

W-R#	Description	Min.	Box
1354300	"Crown-360" - Hinged Flange Repair Ring	1	12



"CROWN QUICK-RING" REPAIR FLANGE

W-R#	Description	Min.	Box
1354700	"Quick Ring"	1	12



W-R SPAN-IT FLANGE

W-R#	Description	Min.	Box
1354002	Span-it flange • Repairs broken closet flanges	1	24



TOILET FLANGE REPAIR KIT

W-R#	Description	Min.	Box
1353600	Repair Kit - Includes screws & washers - Repairs flange & mounts to floor	1	24

TOILET SPECIALTIES



“QUICK-FIX” CLOSET FLANGE SUPPORT KITS

W-R#	Description	Min.	Box
1354602	For PVC	1	12
1354604	For Cast Iron	1	12

- Supports closet flange where subfloor has rotted or been missed.
- Galvanized steel
- Includes CP wood screws



THE "CLAM FLANGE"



2-piece design!

W-R#	Description	Min.	Box
1354500	The Clam	1	12

The "**Clam Flange**" is a premium repair product preferred by professionals!

Manufactured from **extra-thick, rust-resistant 409 stainless**, the Clam Flange's 2-piece design snaps around **AND UNDER** the existing PVC collar--providing excellent structural support! **Made in USA.**



“3-D” ENCAPSULATING REPAIR FLANGE



Problem: Broken Flange Solution: 3-D encapsulation

W-R#	Description	Min.	Box
1354900	3-D Flange	1	12

Anodized aluminum encapsulating repair flange for professional, long-lasting closet flange repair.

Unique **3-D** encapsulating design clamps around and under Cast Iron or PVC flange.



1305006

SOFT-PLASTIC SHIMS



1305008

W-R#	Description	Bag
1305006	Flexible Shims	25
1305008	Soft Shims	25



"BIGFOOT" TOILET BASE PLATE

W-R#	Description	Min.	Box
1305004	"Bigfoot"	1	6

- One piece construction fits most new toilets.

TOILET SPECIALTIES



CLOSET FLANGE EXTENSION KIT

W-R#	Description	Min.	Box
------	-------------	------	-----

1353602 1/4" Kit (3 per) 1 12

- 3 per bag
- Includes 1 pr. 5/16" x 3 1/2" BP Bolts



STACKABLE CLOSET FLANGE EXTENDERS

W-R#	Description	Min.	Box
------	-------------	------	-----

1353604 1/2" thick 1 12
A000352 1/4" thick 1 12

- White ABS



FITALL TANK COVER

W-R#	Description	Min.	Box
------	-------------	------	-----

1354200 Fitall Cover 1 6

- White high impact plastic.
- 8²¹/₃₂" x 22²⁵/₃₂"



WHITE PLASTIC BOLT CAP

W-R#	Style	Min.	Box
------	-------	------	-----

1348002 Molded Prongs Ea 25
1348003 With Clip Pr. 25



"E-Z TWIST" WHITE PLASTIC BOLT CAP

W-R#	Style	Min.	Box
------	-------	------	-----

1348005 E-Z Twist Caps Pr. 12

- Twist-style bolt cap fits 5/16 and 1/4 bolts using furnished adapter. No more loose or lost caps!



NYLON TOILET SEAT BOLT, NUT, & WASHER

W-R#	Description	Min.	Box
------	-------------	------	-----

1365002 5/16" 1 pr. 24



PLASTIC TOILET PAPER ROLLER

W-R#	Description	Min.	Box
------	-------------	------	-----

1363002 White Plastic 25 50
1363004 CP Plastic 6 50

TOILET SPECIALTIES



**BRASS CLOSET SPUD
(WITH WASHER)**

W-R#	Description	Min.	Box
1309016	1" x 3/4"	1	25
1309014	1 1/4" x 3/4"	1	25
1309012	1 1/4" x 1 1/4"	1	25
1309010	1 1/2" x 1 1/4"	1	25
1309008	1 1/2" x 1 1/2"	1	25
1309006	2" x 1 1/4"	1	25
1309004	2" x 1 1/2"	1	25
1309002	2" x 2"	1	25



**BRASS CLOSET SPUD
LOCKNUTS**

Size	Min.	Box
0908008 1 1/4" Brass	1	25
0908010 1 1/2" Brass	1	25
0908012 2" Brass	1	25



**GALVANIZED
FRICTION RING**

W-R#	Description	Min.	Box
2710502	1 1/2"	12	12
2710504	2"	12	12



**FLANGED
SPUD WASHER**

W-R#	Description	Min.	Box
2710002	1" x 3/4"	12	12
2710004	1 1/4"	12	12
2710006	1 1/2"	12	12
2710008	2"	12	12
2710010	2" x 1 1/4"	12	12
2710012	2" x 1 1/2"	12	12



**CHROME-PLATED
BRASS URINAL FLUSH
VALVE**

W-R#	Description	Min.	Box
1355002	1/2" X 3/4"	1	6

• Self cleaning, spring action



**BRASS URINAL
FLANGE KIT**

W-R#	Description	Fits	Min
1353018	4"	Am Std	1
1353020	4 1/4"	Eljer/Gerber	1
1353022	5 1/2"	Crane	1
1353024	6"	Kohler	1



**PVC URINAL
FLANGE KIT**

W-R#	Description	Min
1353030	PVC--Hub	1
1353032	PVC--Spigot	1

- All Urinal Flange Kits contain bolts, nuts, & sponge gasket



**SPONGE RUBBER
GASKET FOR URINAL
FLANGE**

W-R#	Description	Box
2717012	3 1/4"OD x 2 1/4"ID x 1/2"	25

GENUINE REPAIR PARTS FOR



Consider Wal-Rich as your #1 source for Genuine Sloan Regal Flushvalves and replacement parts.

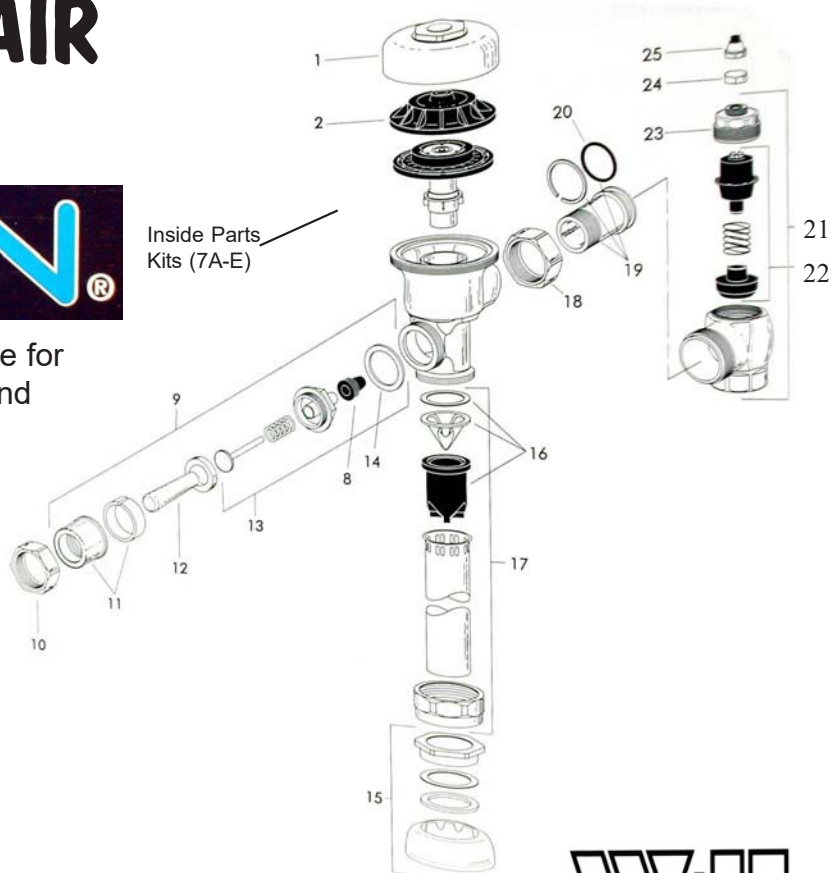

<u>W-R#</u>	<u>Description</u>
1. SR121	CP Cover for Regal (R-10)
2. SR104	Inside Cover (A-71)
3A. SR006	White Relief Valve (A-19-AC)
3B. SR008	Black Relief Valve (A-19-AU)
3C. SR010	Green Relief Valve (A-19-ALC)
4. SR004	Molded Disc (A-15-A)
5. SR102	Sloan Diaphragm (A-156-A)
5A. SR101	Diaphragm w/Copper (A-56-A)
6A. SR110	Guide Assembly (A-163-A)
7A. SR202	Inside Parts Kit - 4.5 C (A-36-A)
7B. SR204	Inside Parts Kit - 1.5 U (A-37-A)
7C. SR206	Inside Parts Kit - 3.5 C (A-38-A)
7D. SR208	Inside Parts Kit - 1.6 C (A-41-A)
7E. SR210	Inside Parts Kit - 1.0 U (A-42-A)
8. SR108	Handle Seal (B-39)
9. SR002	Standard Handle Assy (B-32-A)
9A. SR122	Handicap Handle Assy (B-73)
10. SR118	CP Handle Cplg Nut (A-6)
13. SR106	Handle Repair Kit (B-50-A)
14. SR116	Handle Gasket Only (A-31)
*** SR700	Sloan Super Wrench (A-50)

<u>W-R#</u>	<u>Description</u>
15A. SR302	3/4" Spud Cplg Assy (F-54-A)
15B. SR308	1 1/4" Spud Cplg Assy (F-55-A)
15C. SR310	1 1/2" Spud Cplg Assy (F-56-A)
16. SR602	Sloan Vacuum Breaker (V-551-A)
17A. SR502	3/4" Vac. Breaker Tail (V-500-AA)
17B. SR504	1 1/4" Vac. Breaker Tail (V-500-AA)
17C. SR506	1 1/2" Vac. Breaker Tail (V-500-AA)
17D. SR129	CP Vacuum Breaker Nut (V-553-A)
18. SR128	Tailpiece Coupling Nut (H-550)
19. SR130	CP Adjustable Tail (H-551-A)
20. SR131	Stop Tailpiece O-Ring (H-553)
21A. SR812	3/4" Control Stop (H-740-A)
21B. SR814	1" Control Stop (H-740-A)
22A. SR138	1" Control Stop Rep Kit (H-541-A)
22B. SR144	3/4" Control Stop Rep Kit (H-543-A)
23A. SR134	1" Control Stop Bonnet (H-639)
23B. SR124	3/4" Control Stop Bonnet (H-538)
24. SR146	Control Stop Bonnet Cap (H-37)

REGAL FLUSHOMETERS

- 1. **SR902** Regal 110XL Flushometer 3.5 C
- 2. **SR903** Regal 111XL Flushometer 1.6 C
- 3. **SR904** Regal 186XL Flushometer 1.5 U

GENUINE REPAIR PARTS FOR



Consider Wal-Rich as your #1 source for Genuine Sloan Royal Flushvalves and replacement parts. All available for immediate delivery.

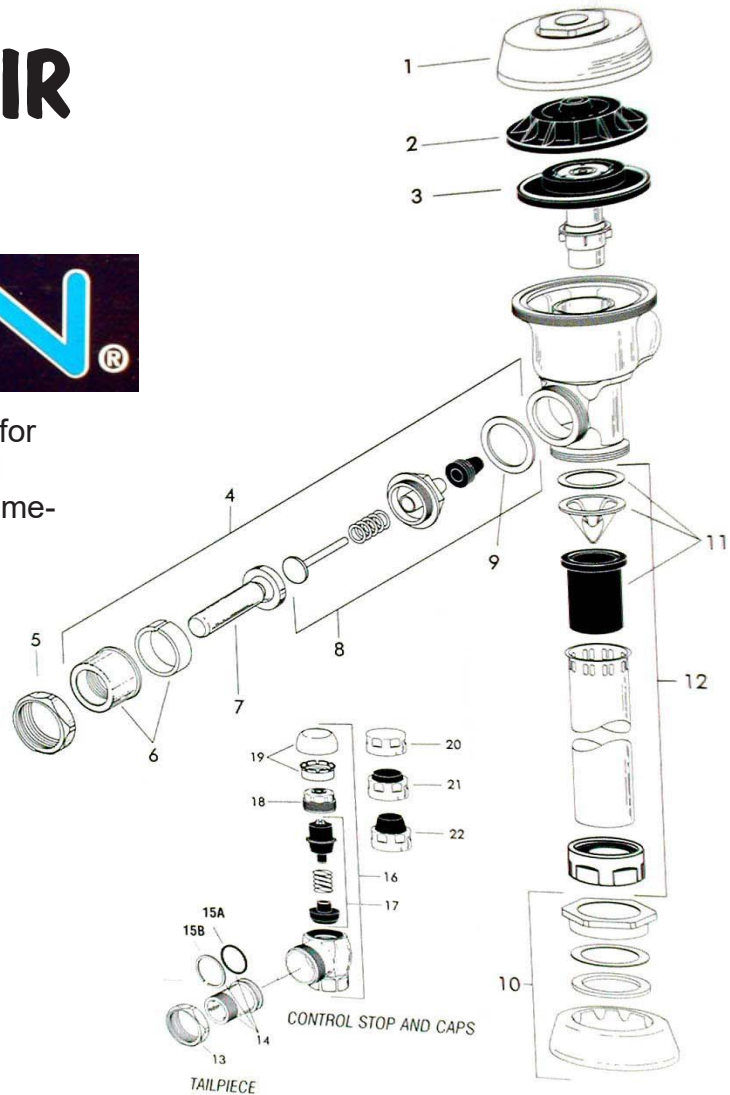

W-R#	Description
1. SR120	CP Cover for Royal (A-72)
2. SR104	Inside Cover (A-71)
3A. SR222	Royal Drop-in Kit 1.5U (A-1037-A)
3B. SR224	Royal Drop-in Kit 3.5C (A-1038-A)
3C. SR226	Royal Drop-in 1.6 C (A-1041-A)
3D. SR228	Royal Drop-in 1.0 U (A-1042-A)
4. SR122	Handicap Handle Assy (B-73-A)
5. SR118	CP Handle Cplg Nut (A-6)
8. SR136	Triple-Seal Handle Rep Kit (B-51-A)
8A. SR108	Handle Seal (B-39)
9. SR116	Handle Gasket Only (A-31)
10A. SR304	3/4" Spud Coupling Assy (F-5-A)
10B. SR306	1 1/4" Spud Coupling Assy (F-5-A)
10C. SR312	1 1/2" Spud Coupling Assy (F-5-A)
11. SR604	Hi-Pressure Vac Breaker (V-651-A)
12A. SR502	3/4" Vac. Breaker Tail (V-500-AA)
12B. SR504	1 1/4" Vac. Breaker Tail (V-500-AA)
12C. SR506	1 1/2" Vac. Breaker Tail (V-500-AA)
12D. SR129	CP Vacuum Breaker Nut (V-553-A)
*** SR700	Sloan Super Wrench (A-50)

W-R#	Description
13. SR128	Tailpiece Coupling Nut (H-550)
14. SR130	CP Adjustable Tail (H-551-A)
15A. SR131	Stop Tailpiece O-Ring (H-553)
17A. SR138	1" Control Stop Rep Kit (H-541-A)
17B. SR144	3/4" Control Stop Rep Kit (H-543-A)
18A. SR126	1" Control Stop Bonnet (H-622)
18B. SR132	3/4" Control Stop Bonnet (H-577)
19A. SR140	1" Vandal-Proof Cap (H-1010-A)
19B. SR142	3/4" Vandal-Proof Cap (H-1009-A)
20A. SR112	1" Control Stop Cap (H-573)
20B. SR114	3/4" Control Stop Cap (H-582)

ROYAL FLUSHOMETERS

- 1. **SR906** Royal 110 Flushometer - Closet
- 2. **SR908** Royal 186 Flushometer - Urinal

The flushometers and repair parts shown on this page refer to the "Dual Filtered" Royal flushometers produced since January of 1998.

GENUINE REPAIR PARTS FOR



Consider Wal-Rich as your #1 source for Genuine Sloan Gem II Flushvalves and replacement parts. All available for immediate delivery.

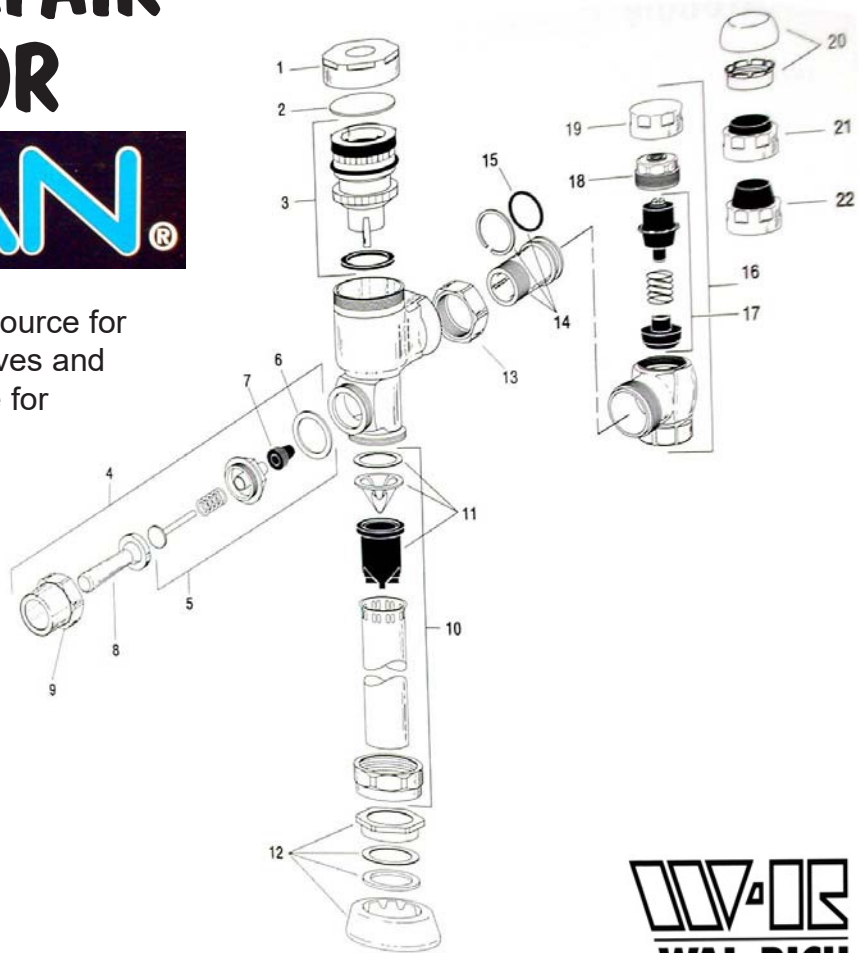

<u>W-R#</u>	<u>Description</u>	<u>W-R#</u>	<u>Description</u>
1. SR408	Gem CP Cover (G-105)	13. SR128	Tailpiece Coupling Nut (H-550)
2. SR406	Gem Slip Disc (G-106)	14. SR130	CP Adjustable Tail (H-551-A)
3A. SR402	Piston for G-75 Urinal (G-1002-A)	15. SR131	Stop Tailpiece O-Ring (H-553)
3B. SR404	Piston for G-75 Closet (G-1003-A)	17A. SR138	1" Control Stop Rep Kit (H-541-A)
3C. SR414	Piston Kit - 3.5 Closet (G-1007-A)	17B. SR144	3/4" Control Stop Rep Kit (H-543-A)
3D. SR416	Piston Kit - 1.6 Closet (G-1016-A)	18A. SR126	1" Control Stop Bonnet (H-622)
3E. SR412	Piston Kit - 1.5 Urinal (G-1009-A)	18B. SR132	3/4" Control Stop Bonnet (H-577)
3F. SR410	Piston Kit - 1.0 Urinal (G-1017-A)	19A. SR112	1" Control Stop Cap (H-573)
4. SR420	Gem Handle Assy (G-143-A)	19B. SR114	3/4" Control Stop Cap (H-582)
5. SR422	Gem Handle Rep Kit (G-50-A)	20A. SR140	1" Vandal-Proof Cap (H-1010-A)
6. SR418	Gem Handle Gasket (G-35)	20B. SR142	3/4" Vandal-Proof Cap (H-1009-A)
7. SR108	Handle Seal (B-39)		
10A. SR502	3/4" Vac. Breaker Tail (V-500-AA)		
10B. SR504	1 1/4" Vac. Breaker Tail (V-500-AA)		
10C. SR506	1 1/2" Vac. Breaker Tail (V-500-AA)		
10D. SR129	CP Vacuum Breaker Nut (V-553-A)		
11. SR602	Sloan Vacuum Breaker (V-551-A)		
12A. SR304	3/4" Spud Coupling Assy (F-5-A)		
12B. SR306	1 1/4" Spud Coupling Assy (F-5-A)		
12C. SR312	1 1/2" Spud Coupling Assy (F-5-A)		
*** SR700	Sloan Super Wrench (A-50)		



Make Wal-Rich your source for Genuine Sloan Flushometers and Repair Parts. All parts are manufactured in the USA by Sloan Valve Company.



**REGAL™
FLUSHOMETERS**

W-R#	Sloan #	Model	GPF
SR902	110XL	Toilet	3.5
SR903	111XL	Toilet	1.6
SR904	186XL	Urinal	1.5

- All Regal™ -XL Flushometers are packaged with control stop and sweat stop conversion kit.



**ROYAL™
FLUSHOMETERS**

W-R#	Sloan #	Model	GPF
SR906	110	Toilet	3.5
SR907	111	Toilet	1.6
SR908	186	Urinal	1.5

- All Royal™ Flushometers are packaged with ADA approved handles and Triple Filter diaphragm.



**CP COVER FOR REGAL
& ROYAL**

W-R#	Description	Sloan#
SR121	Regal CP Cover	R-10
SR120	Royal CP Cover	A-72



INSIDE PLASTIC COVER

W-R#	Description	Sloan#
SR104	Inside Cover	A-71



**MOLDED DISC FOR
REGAL/ROYAL
FLUSHOMETER**

W-R#	Description	Sloan#
SR004	Molded Disc	A-15A



**DIAPHRAGM FOR
REGAL
FLUSHOMETERS**

W-R#	Description	Sloan#
SR102	Diaphragm	A-156-A
SR101	Diaphragm w/Copper Ring	A-56-A
SR199	A-56-A & A-15A	A-56-AA



**RELIEF VALVE FOR
REGAL/ROYAL
FLUSHOMETERS**

W-R#	Description	Sloan#
SR006	White (Toilet)	A-19AC
SR008	Black (Urinal)	A-19AU
SR010	Green (1.6)	A-19ALC

**GENUINE SLOAN®
REPLACEMENT PARTS**



**GUIDE ASSEMBLY FOR
REGAL/ROYAL
FLUSHOMETERS**

W-R#	Description	Sloan#
SR110	Guide Assembly	A-163A



REGAL™ REBUILD KITS



W-R#	Description	Sloan#
SR202	4.5 GPF (Toilet)	A-36A
SR204	1.5 GPF (Urinal)	A-37A
SR206	3.5 GPF (Toilet)	A-38A
SR208	1.6 GPF (Toilet)	A-41A
SR210	1.0 GPF (Urinal)	A-42A
SR212	0.5 GPF (Urinal)	A-43A
SR214	1.28 GPF (Toilet)	A-140A



**ROYAL™ REBUILD KITS
WITH DUAL-FILTERED
DIAPHRAGM**

W-R#	Description	Sloan#
SR222	1.5 GPF (Urinal)	A-1037A
SR224	3.5 GPF (Toilet)	A-1038A
SR226	1.6 GPF (Toilet)	A-1041A
SR228	1.0 GPF (Urinal)	A-1042A



**OPTIMA-PLUS™ &
OPTIMA™ G2
REBUILD KITS**

W-R#	Description	Sloan#
SR950	Urinal	EBV-1022-A
SR952	Closet	EBV-1020-A
SR954	HET Urinal	EBV-1023-A
SR956	HET Closet	EBV-1024-A



**GEM™ PISTON
ASSEMBLIES**

W-R#	Description	Sloan#
SR402	G-75 (Urinal)	G-1002-A
SR404	G-75 (Closet)	G-1003-A
SR414	3.5 GPF (Closet)	G-1007-A
SR416	1.6 GPF (Closet)	G-1016-A
SR412	1.5 GPF (Urinal)	G-1009-A
SR410	1.0 GPF (Urinal)	G-1017-A



**OLD-STYLE GEM™
PISTON PARTS**

W-R#	Description	Sloan#
SR430	Piston Cover	G-77
SR432	Molded Cup	G-78

**GENUINE SLOAN®
REPLACEMENT PARTS**



**VACUUM BREAKER
INSERT FOR ROYAL/
REGAL™**

W-R#	Description	Sloan#
SR602	Insert	V-551A
SR604	Hi-Pressure Insert	V-651A



**HANDLE ASSEMBLY
FOR ROYAL/REGAL/
GEM™**

W-R#	Description	Sloan#
SR002	Regal	B-32A
SR122	Royal	B-73
SR420	Gem	G-143A



**HANDLE COUPLING
NUT FOR ROYAL/
REGAL™**

W-R#	Description	Sloan#
SR118	CP Nut	A-6



**HANDLE REPAIR KIT
FOR REGAL/ROYAL/
GEM™**

W-R#	Description	Sloan#
SR106	Regal	B-50A
SR136	Royal	B-51A
SR422	Gem	G-50A



**HANDLE GASKET &
SEAL FOR ROYAL/
REGAL™**

W-R#	Description	Sloan#
SR108	Handle Seal	B-39
SR116	Handle Gasket	A-31
SR418	Gem Handle Gasket	G-35



**VACUUM BREAKER
TAILPIECE KITS
(WITH NUT & RUBBER)**

W-R#	Description	Sloan#
SR502	3/4" x 9"	V-500-AA
SR504	1 1/4" x 9"	V-500-AA
SR508	1 1/4" x 15"	V-500-AA
SR510	1 1/4" x 22"	V-500-AA
SR506	1 1/2" x 9"	V-500-AA
SR512	1 1/2" x 15"	V-500-AA
SR514	1 1/2" x 22"	V-500-AA

**GENUINE SLOAN®
REPLACEMENT PARTS**



**SPUD COUPLING
ASSEMBLIES**

W-R#	Description	Sloan#
SR302	3/4" Regal	F-54-A
SR304	3/4" Royal/Gem	F-5-A
SR306	1 1/4" Royal/Gem	F-5-A
SR308	1 1/4" Regal	F-55-A
SR310	1 1/2" Regal	F-56-A
SR312	1 1/2" Royal/Gem	F-5-A



**CP VACUUM BREAKER
NUT FOR
ROYAL/REGAL/GEM**

W-R#	Description	Sloan#
SR129	CP Nut	V-553-A



**CP ADJUSTABLE TAIL
FOR ROYAL/REGAL/
GEM**

W-R#	Description	Sloan#
SR130	2 1/16" Tail	H-551-A
SR148	3 1/16" Tail	H-551-A
SR150	4 1/16" Tail	H-551-A
SR152	5 1/16" Tail	H-551-A
SR154	6 1/16" Tail	H-551-A



**CP TAILPIECE COUPLING
NUT FOR
ROYAL/REGAL/GEM**

W-R#	Description	Sloan#
SR128	CP Coupling Nut	H-550



**STOP TAILPIECE
O-RING FOR ROYAL/
REGAL/GEM**

W-R#	Description	Sloan#
SR131	O-Ring	H-553



**CONTROL STOP REPAIR
KIT FOR
ROYAL/REGAL/GEM**

W-R#	Description	Sloan#
SR138	1" Kit	H-541-A
SR144	3/4" Kit	H-543-A



**REGAL™
CONTROL STOPS**

W-R#	Description	Sloan #
SR812	3/4" Control Stop	H-790A-3/4
SR814	1" Control Stop	H-790A-1

**GENUINE SLOAN®
REPLACEMENT PARTS**



**SOLENOID & VALVE
FOR EBF-650
ELECTRONIC FAUCET**



W-R#	Description	Sloan#
SR740	Solenoid & Valve	ETF-740-A



**SOLENOID FOR EBF-650
ELECTRONIC FAUCET**



W-R#	Description	Sloan#
SR742	Solenoid Only	ETF-742-A



**SOLENOID FOR EAF
ELECTRONIC FAUCETS**



W-R#	Description	Sloan#
SR750	Solenoid Only	EAF-2



**SOLENOID FOR BASYS
ELECTRONIC FAUCETS**



W-R#	Description	Sloan#
SR752	0.5 GPF Solenoid	EFX-15-A



**SOLENOID FOR OPTIMA
CONCEALED (PRE-2009)
FLUSHOMETERS**



W-R#	Description	Sloan#
SR932	24V Solenoid	EL-124-2



**SOLENOID FOR
OPTIMA PLUS
FLUSHOMETERS**



W-R#	Description	Sloan#
SR938	Solenoid for Optima-Plus	EBV-144-A



**SOLENOID FOR
OPTIMA PLUS -G2-
FLUSHOMETERS**



W-R#	Description	Sloan#
SR944	Solenoid for Optima G2	EBV-136-A

**GENUINE SLOAN®
REPLACEMENT PARTS**



**ACTUATOR KIT FOR
OPTIMA
FLUSHOMETERS**

W-R#	Description	Sloan#
SR930	Actuator Kit	EL-128-A



**SENSORS FOR 2100 &
2200 SERIES FAUCETS**

W-R#	Description	Sloan#
SR760	4-pin sensor	SFP-34
SR762	6-pin sensor	SFP-41-A



**SENSORS FOR EAF
FAUCETS**

W-R#	Description	Sloan#
SR730	EAF-275 Less IQ	EAF-14-A
SR732	EAF-275 With IQ	EAF-16-A

SR732	EAF-250 With IQ	EAF-20-A
SR734	EAF-250 Less IQ	EAF-21-A



**SENSOR FOR OPTIMA
CONCEALED (PRE-2009)
FLUSHOMETERS**

W-R#	Description	Sloan#
SR770	Urinal Sensor	EL-1500
SR772	Closet Sensor	EL-1500L



**SENSOR FOR OPTIMA
CONCEALED (PRE-2009)
FLUSHOMETERS**

W-R#	Description	Sloan#
SR940	Closet Module	EBV-129AC
SR942	Urinal Module	EBV-129AU



**GENUINE SLOAN®
REPLACEMENT PARTS**



**CP CONTROL STOP
CAP**

W-R#	Description	Sloan#
SR112	1" Cap	H-573
SR114	3/4" Cap	H-582



**CP VANDAL-PROOF
CONTROL STOP CAP**

W-R#	Description	Sloan#
SR140	1" V.P. Cap	H-1010-A
SR142	3/4" V.P. Cap	H-1009-A



**GENUINE SLOAN
"SUPER-WRENCH"®**

W-R#	Description	Sloan #
SR700	Wrench	A-50



**"SPUD BUDDY"
FLUSHOMETER SPUD
WRENCH**

W-R#	Description	Sloan #
1851000	Fits H-551-A	-

Spud
Buddy®



Used to adjust or remove flushometer tailpieces during rough-in or replacement.



Consider Wal-Rich your prime source for Genuine Sloan Flushmate parts and accessories. All Flushmate parts are made in the USA and furnished in original packaging.



**GENUINE SLOAN
FLUSHMATE®
REPLACEMENT
CARTRIDGE**

W-R#	Description	Sloan#
FM002	1.6 & 1.0 gpf	C100500K
FM030	1.28 gpf	C100501K



**GENUINE SLOAN
FLUSHMATE® UPPER
SUPPLY, ONLY**

W-R#	Description	Sloan#
FM006	Upper Supply	BU100505K



**GENUINE SLOAN
FLUSHMATE® 501-B
RETROFIT TANK KIT
(USES 503 TANK)**

W-R#	Description	Sloan#
FM300	Replacement Tank to fit 501-B Series Tanks	M-101526-F3BK

- Replaces the following Flushmate® Tanks:
M-101526-F
M-101526-FA
M-101526-FH
M-101526-FHA



**GENUINE SLOAN
FLUSHMATE® 503
TANK**

W-R#	Description	Sloan#
FM200	503 Tank	M-101526-F31

- 1.6 gpf for all OEMs except Kohler K4404 tank and Gerber 28-385 tank

FM400	503 Tank	M-101526-F33
-------	----------	--------------

- 1.6 gpf for Gerber 28-385 tank



**GENUINE SLOAN®
FLUSHMATE & PARTS**



**GENUINE SLOAN
FLUSHMATE® HANDLE
REPLACEMENT KIT**

W-R#	Description	Sloan#
FM020	Handle Kit	AP300503

- For OEM tanks with Flushmate 503 series and flush handle



**GENUINE SLOAN
FLUSHMATE® TANK-TO-
BOWL GASKET**

W-R#	Description	Sloan#
FM070	Gasket	E-205288

- Fits all models except Mansfield



FM050



FM052

**GENUINE SLOAN
FLUSHMATE® TOOLS**

W-R#	Description	Sloan#
FM050	Nut Wrench	ST100100
FM052	Cartridge Wrench	ST100500



1318090



1318094



1318092



1318096

**TANK LEVERS FOR
PRESSURE ASSIST
TOILETS**

W-R#	Description	Fits REF#
1318090	To Fit Gerber	99-0571-KT
1318092	To Fit Am Std	738473-0020A
1318094	To Fit Am Std	738153-0020A
1318096	To Fit Am Std	738254-0020A

GENUINE REPAIR PARTS FOR



Consider Wal-Rich as your #1 source for Genuine Delany Rex & Flushboy Flushvalves and replacement parts. All available for immediate delivery.

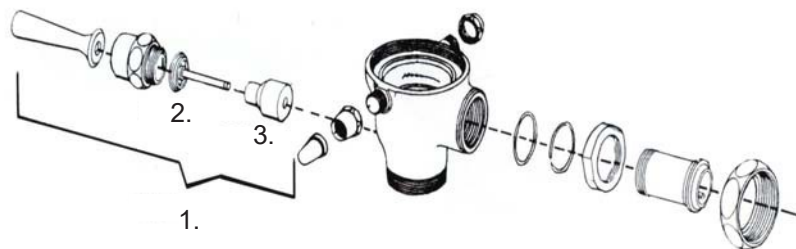
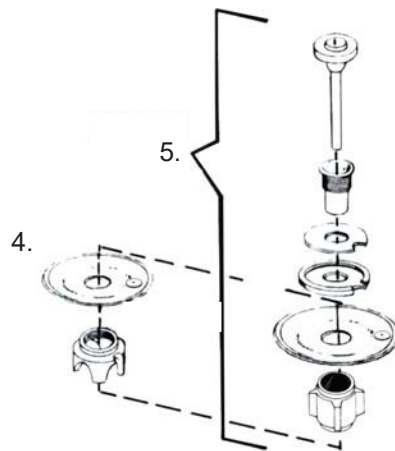
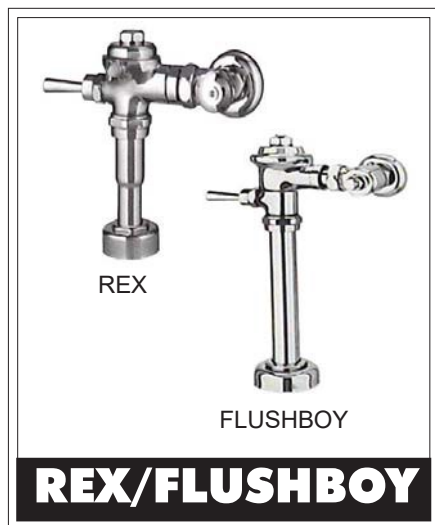

REX FLUSHOMETER PARTS

<u>W-R#</u>	<u>C-D #</u>	<u>Description</u>
1. CD001	R333A	Handle Assembly
2. CD002	R223-2	Brass Operating Stem
3. CD004	R222-3	Rubber Flexor
4. CD201	R107KC	Diaphragm Kit 4.5 Closet
CD202	R107-3KC	Diaphragm Kit 3.5 Closet
CD203	R107-1.6KC	Diaphragm Kit 1.6 Closet
CD204	R107KU	Diaphragm Kit 3.5 Urinal
CD205	R107-1KU	Diaphragm Kit 1.0 Urinal
5. CD101	R107AC	Drop-In Repair Kit 4.5 Closet
CD102	R107-3AC	Drop-In Repair Kit 3.5 Closet
CD103	R107-1.6AC	Drop-In Repair Kit 1.6 Closet
CD104	R107AU	Drop-In Repair Kit 3.5 Urinal

FLUSHBOY FLUSHOMETER PARTS

<u>W-R#</u>	<u>C-D #</u>	<u>Description</u>
1. CD001	R333A	Handle Assembly
2. CD002	R223-2	Brass Operating Stem
3. CD004	R222-3	Rubber Flexor
4. CD301	F141KC	Diaphragm Kit 4.5 Closet
CD302	F141-3KC	Diaphragm Kit 3.5 Closet
CD303	F141-1.6KC	Diaphragm Kit 1.6 Closet
CD304	F141KU	Diaphragm Kit 3.5 Urinal
5. CD401	F141ACQ	Drop-In Repair Kit 4.5 Closet
CD402	F141-3ACQ	Drop-In Repair Kit 3.5 Closet
CD403	F141-1.6ACQ	Drop-In Repair Kit 1.6 Closet
CD404	F141AU	Drop-In Repair Kit 3.5 Urinal



Make Wal-Rich your source for Genuine Delany Flushometers and Repair Parts. All parts are manufactured in the USA by Coyne and Delany Company.



**GENUINE DELANY®
DROP-IN REBUILD KITS
FOR REX**

**LEATHER
KITS**



W-R#	Description	Delany#
CD101	4.5 Closet	R107AC
CD102	3.5 Closet	R107-3AC
CD103	1.6 Closet	R107-1.6AC

CD502 3.5 Closet R107-3AC-L



**GENUINE DELANY®
REPLACEMENT
DIAPHRAGMS FOR REX**

W-R#	Description	Delany#
CD201	4.5 Closet	R107KC
CD202	3.5 Closet	R107-3KC
CD203	1.6 Closet	R107-1.6KC
CD204	3.5 Urinal	R107KU
CD205	1.0 Urinal	R107-1KU



**GENUINE DELANY®
DROP-IN REBUILD KITS
FOR FLUSHBOY**

W-R#	Description	Delany#
CD401	4.5 Closet	F141ACQ
CD402	3.5 Closet	F141-3ACQ
CD403	1.6 Closet	F141-1.6ACQ
CD404	1.0 Urinal	F141AU



**GENUINE DELANY®
REX FLUSHOMETERS**

W-R#	Description	Delany#
CD902	1.6 Closet	R401-1.6GNF
CD904	3.5 Closet	R401-3RTNF
CD906	1.0 Urinal	R451-1

- Furnished complete with control stop



**GENUINE DELANY®
KWIKFIT TAILPIECES**

W-R#	Description	Delany#
CD702	3" Tailpiece	64-1
CD704	4" Tailpiece	64-2
CD706	5" Tailpiece	64-3

REPLACEMENT PARTS FOR DELANY FLUSHVALVES



C.P. HANDLE ASSEMBLY

W-R#	Description	To Fit#
CD001	Handle Assembly	R333A



VACUUM BREAKER TO FIT DELANY

W-R#	Description	To Fit#	Box
CD005	Insert	427A	25



OPERATING STEM TO FIT DELANY

W-R#	Description	To Fit #	Box
CD002	1 15/16"	223-2	25
CD006	1 29/32"	33	25



RUBBER FLEXOR TO FIT DELANY

W-R#	Description	To Fit #	Box
CD004	Flexor	222-3	25



UNIVERSAL LEATHER WASHER KIT TO FIT DELANY

W-R#	Description	To Fit #	Box
2741002	Leather	Rex	25

- Universal Kit features 3 bypasses to accommodate 1.0, 1.6, & 3.5 GPF.
- Real leather diaphragm

REPAIR PARTS TO FIT AMERICAN STANDARD

FITS "HERITAGE"



AS002 Shower (H & C) Pr.
AS003 Diverter Ea.

FITS "HERITAGE" - LARGE



AS018 Shower (H & C) Pr.
AS020 Diverter Ea.

FITS "WRISTBLADE"



AS009 Wristblade Pr.

FITS "AQUASEAL"



AS402HLF Hot Stem Ea.
AS402CLF Cold Stem Ea.
2722002 Washer Only 100

FITS "CADET"



AS409HLF Hot Stem Ea.
AS409CLF Cold Stem Ea.
2722004 Washer Only 24

FITS "AQUASEAL" RETROFIT



AS406HLF Hot Stem Ea.
AS406CLF Cold Stem Ea.

Please Note: For identification purposes only, original manufacturers' names may appear in the description of Wal-Rich replacement parts. These parts should not be confused with the OEM part, unless specified with an original logo.

FITS "AQUASEAL"



AS404LF Bonnet Nut Ea.

FITS "AQUASEAL" DIVERTER



AS412 Diverter Ea.

FITS "HERITAGE"



AS101 Escutcheon Ea.

FITS "HERITAGE"



AS201 Sleeve Ea.

FITS "AQUASEAL" SEAT



4666022 Seat 25/bag

**REPAIR PARTS TO FIT
CENTRAL BRASS**

FITS CENTRAL BRASS



CB001 Basin (H & C) Pr.

FITS CENTRAL BRASS



CB003 Shower (H & C) Pr.
CB004 Diverter Ea.

FITS CENTRAL BRASS



CB002 Shower (H & C) Pr.
CB005 Diverter Ea.

FITS CENTRAL BRASS



CB006 Wristblade Pr.

FITS CENTRAL BRASS



CB402HLF Hot Basin Stem Ea.
CB402CLF Cold Basin Stem Ea.

FITS CENTRAL BRASS



CB404HLF Hot Basin Stem Ea.
CB404CLF Cold Basin Stem Ea.

FITS CENTRAL BRASS

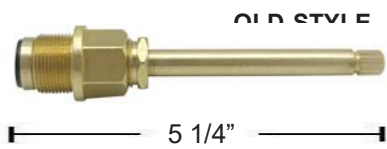

CB410 Shower (H/C) Ea.

FITS CENTRAL BRASS



CB412 Diverter Ea.

FITS CENTRAL BRASS

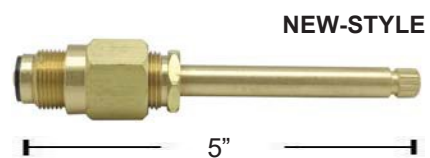

CB415 Shower (H/C) Ea.

FITS CENTRAL BRASS



CB417 Diverter Ea.

FITS CENTRAL BRASS

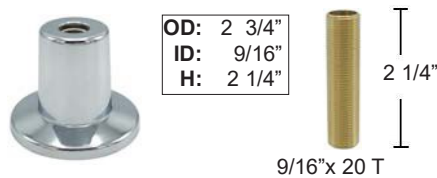

CB202 Escutcheon Ea.
CB502 Escutcheon Nipple Ea.

FITS CENTRAL BRASS



4666008 Seat-1/2" 25/Bag.
4666003 Seat-5/8" 25/Bag

REPAIR PARTS TO FIT CHICAGO

FITS "QUATURN"



2 3/4"



CH002LF Hot Stem Ea.
CH004LF Cold Stem Ea.

REPAIR PARTS TO FIT CRANE

FITS "DIALEZE"



2 1/4"



CR201HLF Hot Stem Ea.
CR201CLF Cold Stem Ea.
1304300 Washer 12
1304302 Adapter 12

REPAIR PARTS TO FIT DELTA

FITS DELTA "D" Broach Fits #H21 



1 7/8"

DD014 Basin (H & C) Pr.

FITS DELTA Round Broach Fits #RP2389 



DD006 Single Lever with Adapter Ea.

FITS DELTA Offset Diamond Broach Fits #RP2391 



DD004 Shower with Offset Broach Pr.

Please Note: For identification purposes only, original manufacturers' names may appear in the description of Wal-Rich replacement parts. These parts should not be confused with the OEM part, unless specified with an original logo.

FITS DELTA Oval Broach Fits #RP2392 



DD010 Scald-Gard Shower Ea.

FITS DELTA



1674002 Stem Only Ea.
1674012 Stem with S.S. Disc Ea.

FITS DELTA Fits RP-70



4671002 Brass Ea.
1671006 Stainless Steel Ea.

FITS DELTA Fits RP-212



4671004 Brass Ea.

**REPAIR PARTS TO FIT
DELTA (continued)**

FITS DELTA Fits RP-1740



DD102 3" Extender Ea.

FITS DELTA



1674010 Diverter Ea.

FITS DELTA Fits RP-19804



1674020 Fits Monitor Ea.

FITS DELTA



New Style
Short
seats &
springs

1675500 Faucet 25
1676500 Shower 25

FITS DELTA



Old Style
(pre-1972)
Long
seats &
springs

1676002 Faucet 25

FITS DELTA



New-Style
(Short)

Old-Style
(Long)

1674500 New-Style 25
1675002 Old-Style 25

FITS DELTA



1673010 C.P. Cap Assembly Ea.

Please Note: For identification purposes only, original manufacturers' names may appear in the description of Wal-Rich replacement parts. These parts should not be confused with the OEM part, unless specified with an original logo.

FITS DELTA



ID: 1 13/16"
L: 7 1/4"
W: 5 3/8"

1673004 Less Diverter

REPAIR PARTS TO FIT GERBER

FITS GERBER



GB005 Basin (H & C) Pr.

FITS GERBER



GB001 Shower (H & C) Pr.
GB002 Diverter Ea.

FITS GERBER



GB030 Wristblade Pr.

FITS GERBER



GB003 Shower (H & C) Pr.
GB006 Diverter Ea.

FITS GERBER



GB007 Shower (H & C) Pr.
GB008 Diverter Ea.

FITS GERBER



1672020 Loop Handle Ea.

FITS GERBER



GB407HLF Hot Basin Ea.
GB407CLF Cold Basin Ea.

FITS GERBER



GB401 Shower (H/C) Ea.

FITS GERBER



GB412 Diverter Ea.

FITS GERBER



1672002 Cartridge Ea.

FITS GERBER



OD: 2 3/4"
ID: 1 1/8"
H: 3/8"

GB101 Escutcheon Ea.

FITS GERBER



OD: 1 1/8"
L: 3 3/4"

GB201 Shower Sleeve Ea.

REPAIR PARTS TO FIT GERBER (continued)

FITS GERBER



4667002 Seat 25

FITS GERBER



A000178 Basin Washer 25
1304514 Diverter Washer 25

FITS GERBER



GB302 Hot Button 10
GB304 Cold Button 10
GB306 Diverter Button 10

FITS GLACIER BAY



GL402H Hot Ea.
GL402C Cold Ea.

REPAIR PARTS TO FIT GLACIER BAY

FITS GLACIER BAY



GL404H Hot Ea.
GL404C Cold Ea.

FITS KOHLER

Trend Style



KK001 Basin (H & C) Pr.
KK002 Shower (H & C) Pr.
KK003 Diverter

REPAIR PARTS TO FIT KOHLER

Please Note: For identification purposes only, original manufacturers' names may appear in the description of Wal-Rich replacement parts. These parts should not be confused with the OEM part, unless specified with an original logo.

FITS KOHLER

Trend Style



KK402HLF Hot Basin Ea.
KK402CLF Cold Basin Ea.

FITS KOHLER

Trend Style



KK410H Hot Shower Ea.
KK410C Cold Shower Ea.

FITS KOHLER

Trend Style



KK412 Diverter Ea.

FITS KOHLER

Valvet Style



KK404HLF Hot Stem Ea.
KK404CLF Cold Stem Ea.

FITS KOHLER



Trend Style

27 TPI



4666024 Seat

25

FITS KOHLER



27 TPI



4666004 Seat

25

FITS KOHLER



BR101 Single-Lever Ea.

REPAIR PARTS TO FIT MOEN

FITS MOEN-CHATEAU



MM002 Basin Ea.
MM004 Shower Ea.

FITS MOEN-POSITEMP



MM030 Shower Ea.

FITS MOEN



FOR SHOWER ONLY

4304704 Fits 1200B Ea.

FITS MOEN



FOR SHOWER ONLY

1304702 Fits 1225B Ea.

FITS MOEN



1304705 Fits 1222 Positemp Ea.

FITS MOEN



1304712 Fits 1224B Ea.

FITS MOEN



1304604 Clip for #883 Ea.

FITS MOEN



1304610 Spout Seal Kit Ea.

Please Note: For identification purposes only, original manufacturers' names may appear in the description of Wal-Rich replacement parts. These parts should not be confused with the OEM part, unless specified with an original logo.

**REPAIR PARTS TO FIT
PRICE-PFISTER**

FITS PRICE-PFISTER



PP006 Basin (H & C) Pr.
PP004 Shower (H & C) Pr.
PP005 Diverter Pr.

FITS PRICE-PFISTER



PP007 Basin (H & C) Pr.

FITS PRICE-PFISTER

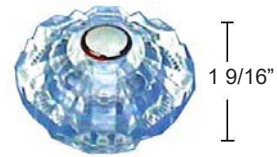

PP022 Fits Avanti Ea.

FITS PRICE-PFISTER



PP402LF Basin (H & C) Pr.

FITS PRICE-PFISTER



PP410 Shower (H/C) Ea.

FITS PRICE-PFISTER



PP414 Diverter Ea.

FITS PRICE-PFISTER



PP412 Shower (H /C) Ea.

FITS PRICE-PFISTER

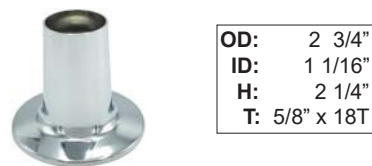

PP202 Escutcheon Ea.

FITS PRICE-PFISTER



PP502 Plastic Nipple 6

FITS PRICE-PFISTER



4666038 Seat 25

FITS PRICE-PFISTER



4666010 Seat 25

REPAIR PARTS TO FIT SAVOY

FITS SAVOY



SY001 Basin/Shower Pr.

FITS SAVOY



SY002 Basin/Shower Pr.

FITS SAVOY



Fits A-68



SV402HLF Hot Basin Ea.
SV402CLF Cold Basin Ea.

FITS SAVOY

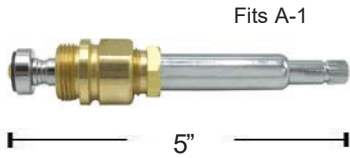

SV410 Shower (H/C) Ea.

FITS SAVOY



SV411 Shower (H/C) Ea.

FITS SAVOY



OD: 2 13/16"
ID: 5/8"
H: 1 11/16"

SY102 Escutcheon Ea.

FITS SAVOY



OD: 2 3/4"
ID: 1 1/16"
H: 3/8"

SY103 Escutcheon Ea.

FITS SAVOY



OD: 1"
L: 2 3/4"

SY201 Sleeve Ea.

FITS SAVOY



4666030 Seat 25

Please Note: For identification purposes only, original manufacturers' names may appear in the description of Wal-Rich replacement parts. These parts should not be confused with the OEM part, unless specified with an original logo.

REPAIR PARTS TO FIT SAYCO

FITS SAYCO



SA001 Shower (H & C) Pr.
SA006 Diverter Ea.

FITS SAYCO

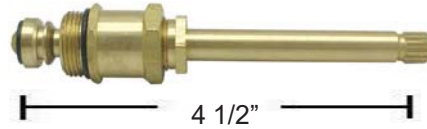

SA401H H/C Shower Ea.

FITS SAYCO



SA412 Diverter Ea.

FITS SAYCO



SA101 Escutcheon Ea.

FITS SAYCO



SA201 Sleeve Ea.

FITS SAYCO



4666032 Seat 25

REPAIR PARTS TO FIT STERLING

FITS STERLING



ST003 Basin (H & C) Ea.

FITS STERLING



ST006 Shower (H & C) Pr.
ST004 Diverter Ea.

FITS STERLING



ST410 Shower (H/C) Ea.

FITS STERLING



ST412 Diverter Ea.

FITS STERLING



4666020 Seat 25

FITS STERLING



ST102 Escutcheon Ea.

**REPAIR PARTS TO FIT
STERLING (CONTINUED)**

FITS STERLING



OD: 1 1/4"
ID: 1 1/8"
H: 2 1/2"

ST202 Sleeve Ea.

Please Note: For identification purposes only, original manufacturers' names may appear in the description of Wal-Rich replacement parts. These parts should not be confused with the OEM part, unless specified with an original logo.

**REPAIR PARTS TO FIT
SYMMONS**

FITS SYMMONS



SM001 Shower Ea.

FITS SYMMONS

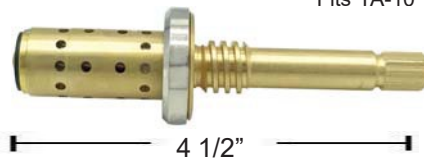

Fits TA-10

SM401 Fits Temptrol Ea.

FITS SYMMONS



Fits TA-4

Fits TA-9

1304200 Seat Kit Ea.

1304202 Repair Kit Ea.

**REPAIR PARTS TO FIT
T & S BRASS**

FITS T & S



CJ302 Handle (H & C) Pr.

FITS T & S



CJ401HLF Hot Stem Ea.

CJ401CLF Cold Stem Ea.

FITS T & S



2 3/4"



CJ500HLF Hot Spindle Assy Ea.

CJ500CLF Cold Spindle Assy Ea.

**REPAIR PARTS FOR
UNIVERSAL FIT**

UNIVERSAL FIT



OD: 2 7/8"
ID: 3/4"
H: 1 3/4"

0622002 Untapped Ea.

UNIVERSAL FIT



1633302 Crystal Handle Pr.

UNIVERSAL FIT



1632002 Cross Handle Pr.

UNIVERSAL FIT



1633002 Lever Handle Pr.

UNIVERSAL FIT



HH001 Wristblade Pr.

UNIVERSAL FIT



1621002 "Crown" Fitall Pr.

UNIVERSAL FIT



1634002 Universal Shower

- Fits Grohe, Danfoss, Gerber, Central, Newport Brass, Altmans, etc.

UNIVERSAL FIT



1652020 Universal S/L Faucet

- Fits Gerber & many imported faucet models.

SHOWER REBUILD KITS

Each kit includes the stems, seats, handles, and trim for the most popular 3 valve shower bodies.



FITS AMERICAN STANDARD



ASK01- Heritage

EACH KIT CONTAINS:		
W-R #	Description	Qty
AS002	Hot/Cold Handle	1 pr.
AS003	Diverter Handle	1
AS402H	Hot Stem	1
AS402C	Cold Stem	1
AS412	Diverter Stem	1
AS404	Stem Bushing	1
AS101	Escutcheon	3
AS201	Sleeve	3
4666022	Seat - (11/32" H - 7/16" x 24T)	2
4666023	Seat - (3/8" H - 35/64" x 18T)	1

FITS CENTRAL BRASS



CBK01 - Old Style Stems

EACH KIT CONTAINS:		
W-R #	Description	Qty
CB003	Hot/Cold Handle	1 pr.
CB004	Diverter Handle	1
CB410	Hot/Cold Stem	2
CB412	Diverter Stem	1
CB202	Sleeve/Escutcheon	3
CB502	Brass Escutcheon Nipple	3
4666003	Seat (21/32" H - 5/8" x 24T)	3



CBK01-P - New Style Stems

EACH KIT CONTAINS:		
W-R #	Description	Qty
CB003	Hot/Cold Handle	1 pr.
CB004	Diverter Handle	1
CB415	N/S Hot/Cold Stem	2
CB417	N/S Diverter Stem	1
CB202	Sleeve/Escutcheon	3
CB502	Brass Escutcheon Nipple	3
4666003	Seat (21/32" H - 5/8" x 24T)	3

SHOWER REBUILD KITS

FITS GERBER



GBK01 - Long Broach

EACH KIT CONTAINS:		
W-R #	Description	Qty
GB003	Hot/Cold Long Broach Handles	1 pr.
GB006	Diverter Long Broach Handle	1
GB401	Hot/Cold Stem	2
GB412	Diverter Stem	1
GB101	Escutcheon	3
GB201	Sleeve	3
4667002	Seat (7/16" H - 5/8" x 20T)	3



GBK02 - Short Broach

EACH KIT CONTAINS:		
W-R #	Description	Qty
GB007	Hot/Cold Short Broach Handles	1 pr.
GB008	Diverter Short Broach Handle	1
GB401	Hot/Cold Stem	2
GB412	Diverter Stem	1
PP202	Escutcheon	3
0623008	Fitall Escutcheon Nipple	3
4667002	Seat (7/16" H - 5/8" x 20T)	3

FITS KOHLER



KKK01 - Trend

EACH KIT CONTAINS:		
W-R #	Description	Qty
KK002	Hot/Cold Handle	1 pr.
KK003	Diverter Handle	1
KK410H	Hot Stem	1
KK410C	Cold Stem	1
KK412	Diverter Stem	1
KK102	Escutcheon	3
4666004	Seat (3/8" H - 1/2" x 27T)	3

FITS PRICE-PFISTER



PPK01 - "Verve"

EACH KIT CONTAINS:		
W-R #	Description	Qty
PP004	Hot/Cold Handles	1 pr.
PP005	Diverter Handle	1
PP410	Hot/Cold Stem - Less Threads	2
PP414	Diverter Stem - Less Threads	1
PP202	Escutcheon	3
PP502	Escutcheon Nipple	3
4666010	Seat (3/8" H - 21/32" x 18T)	3

SHOWER REBUILD KITS

FITS SAYCO



SAK01

EACH KIT CONTAINS:		
W-R #	Description	Qty
SA001	Hot/Cold Handles	1 pr.
SA006	Diverter Handle	1
SA401H	H/C Stem	2
SA412	Diverter Stem	1
SA101	Escutcheon	3
SA201	Sleeve	3
4666032	Seat (5/16" H - 1/2" x 20T)	3

FITS STERLING



STK01

EACH KIT CONTAINS:		
W-R #	Description	Qty
ST006	Hot/Cold Handles	1 pr.
ST004	Diverter Handle	1
ST410	H/C Stem	2
ST412	Diverter Stem	1
ST102	Escutcheon	3
ST202	Sleeve	3
4666020	Seat (3/8" H - 1/2" x 24T)	3

BASIN REBUILD KITS

FITS GERBER



GBF1LF

EACH KIT CONTAINS:		
W-R #	Description	Qty
GB005	Hot/Cold Basin Handle	1 pr.
GB407HLF	Hot Basin Stem	1
GB407CLF	Cold Basin Stem	1
4667002	Seat (7/16" H - 5/8" x 20T)	2

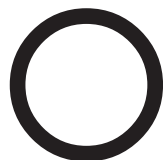

1670002



1670004

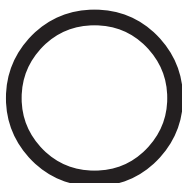

1670006



1670008



1670010



1670012

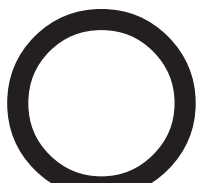

1670014

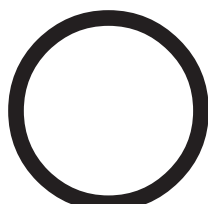

1670016

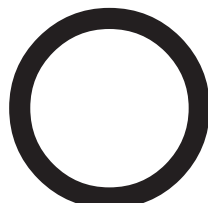

1670018



1670020



1670022



1670024

W-R#	Description	Min.	Box
------	-------------	------	-----

1670002	A	100	
----------------	----------	-----	--

¹³/₁₆" O.D. x ⁵/₈" I.D. x ³/₃₂"
Fits Price-Pfister, Arrowhead, Am. Standard

1670004	B	100	
----------------	----------	-----	--

⁷/₈" O.D. x ¹¹/₁₆" I.D. x ³/₃₂"
Fits Kohler, Central, Gopher, Republic, Briggs, Mullins, Schaible, Am. Standard, Chase, Milwaukee Faucet.

1670006	C	100	
----------------	----------	-----	--

¹⁵/₁₆" O.D. x ³/₄" I.D. x ³/₃₂"
Fits Kohler, Union Brass, Gerber, Indiana Brass, Sayco, Am. Standard.

1670008	D	100	
----------------	----------	-----	--

³/₈" O.D. x ¹/₄" I.D. x ¹/₁₆"
Fits Acme Brass.

1670010	E	100	
----------------	----------	-----	--

⁷/₁₆" O.D. x ⁵/₁₆" I.D. x ¹/₁₆"
Fits Central Brass, Eljer, Milwaukee Faucet, Chase.

1670012	F	100	
----------------	----------	-----	--

⁹/₁₆" O.D. x ³/₈" I.D. x ³/₃₂"
Fits General Brass, Arrowhead, Repcal, Gerber, Milwaukee Faucet, Savoy, Am. Standard, Harcraft.

1670014	G	100	
----------------	----------	-----	--

1" O.D. x ³/₄" I.D. x ¹/₈"
Fits Crane, Milwaukee Faucet.

1670016	H	100	
----------------	----------	-----	--

¹¹/₁₆" O.D. x ¹³/₁₆" I.D. x ¹/₈"
Fits Eljer, Moen, Chase.

1670018	I	100	
----------------	----------	-----	--

¹¹/₈" O.D. x ⁷/₈" I.D. x ¹/₈"
Fits Mullins, Repcal, Harcraft.

1670020	J	100	
----------------	----------	-----	--

⁵/₈" O.D. x ⁷/₁₆" I.D. x ³/₃₂"
Fits Central, Chase, Scovil Ballcock, Savoy.

1670022	K	100	
----------------	----------	-----	--

¹¹/₁₆" O.D. x ¹/₂" I.D. x ³/₃₂"
Fits Eljer, Moen, Sayco, Dishmaster.

1670024	L	100	
----------------	----------	-----	--

³/₄" O.D. x ⁹/₁₆" I.D. x ³/₃₂"
Fits Central, Schaible, Eljer, Price Pfister, Chase, Milwaukee Faucet.

O-RING ASSORTMENT KITS



1668002 150 Piece Assortment

FAUCET & SHOWER SEATS



BRASS SEAT KITS

NYC FAUCET SEAT KIT

4 KOHLER 1/2 x 27 4666004	6 AM-STD BARNES 1/2 x 20 4666014	16 AMER. STD. 7/16 x 24 4666022	12 GERBER 5/8 x 20 4667002	10 SAVOY 3/16 x 20 4666030	10 CENTRAL 1/2 x 24 4666008
4 SAYCO-YOUNG 1/2 x 20 4666032	6 UNION 33/64 x 18 4666034			10 STERLING 1/2 x 24 4666020	10 PRICE PFISTER 1/2 x 20 4666038
4 AMER. STD. 35/64 x 24 4666002	6 ELJER 1/2 x 27 4666012				

CROWN FAUCET SEAT KIT

4666002 AMERICAN STANDARD	4666004 KOHLER	4666006 BARNES DICK	4666008 CENTRAL STERLING	4666010 BRIGGS REPUBLIC	4666012 ELJER
4666014 AM. STD. BARNES CROSLY SAYCO Y'NGSTOWN.	4666016 SCHAIBLE	4666018 SPEAKMAN	4666020 STERLING	4666022 AMERICAN STANDARD	4666024 BARNES
4666026 INDIANA MILWAUKEE	4666028 MILWAUKEE	4666030 SAVOY	4666032 SAYCO Y'NGSTOWN	4666034 UNION	4666036 UNIVERSAL RUNDLE

W-R#	Description	Min	Box
4663002	NYC Seat Kit	1	12

- 100 of the 12 most popular sizes in the New York region.



W-R#	Description	Min	Box
4664002	Crown Seat Kit	1	12

- 100 of the 18 most popular size seats



SEAT GAUGE



W-R#	Description	Min	Box
1850000	Seat Gauge	1	6

- 16 measurements



BRASS BIBB SCREWS

W-R#	Description	Min	Box
1683002	3/8" x 6/32"	100	100
1683004	3/8" x 8/32"	100	100
1683006	3/8" x 10/32"	100	100
1683008	3/8" x 10/24"	100	100
1684002	1/2" x 6/32"	100	100
1684004	1/2" x 8/32"	100	100
1684006	1/2" x 10/32"	100	100
1684008	1/2" x 10/24"	100	100

W-R#	Description	Min	Box
1681002	100 pc Assorted	1	12

GENUINE DELTA® PARTS



**GENUINE DELTA®
#70 BALL**

W-R#	Description	Min.
ODP20	RP70 Ball	1



**GENUINE DELTA®
#212 BALL**

W-R#	Description	Min.
ODP22	RP212 Ball	1



**GENUINE DELTA®
SEATS & SPRINGS**

W-R#	Description	Min.
ODP28	RP4993	1



**GENUINE DELTA®
REPAIR KIT**

W-R#	Description	Min.
ODP30	RP3614	1



**GENUINE DELTA®
SPRAY DIVERTER**

W-R#	Description	Min.
ODP36	RP320	1



**GENUINE DELTA®
BALANCING SPOOL**

W-R#	Description	Min.
ODP51	RP574	1

GENUINE DELTA® PARTS



**GENUINE DELTA®
STEM UNIT**

W-R#	Description	Min.
ODP34	RP1740	1



**GENUINE DELTA®
SHOWER CARTRIDGE**

W-R#	Description	Min.
ODP52	RP19804	1



**GENUINE DELTA®
SHOWER CARTRIDGE**

W-R#	Description	Min.
ODP54	RP32104	1



**GENUINE DELTA®
SHOWER CARTRIDGE**

W-R#	Description	Min.
ODP56	RP1991	1



**GENUINE DELTA®
SHOWER CARTRIDGE**

W-R#	Description	Min.
ODP57	RP46463	1



**GENUINE DELTA®
SHOWER CARTRIDGE**

W-R#	Description	Min.
ODP58	RP46074	1

**GENUINE GERBER®
PARTS**

GERBER®

PROFESSIONAL PERFORMANCE



GERBER.

**GENUINE GERBER®
SHOWER CARTRIDGE**

W-R#	Description	For Series
GB501	"Safetemp"	49-400/700
GB502	"Hardwater"	49-600/800

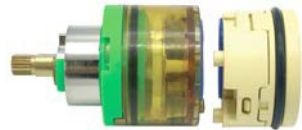

GERBER.

**GENUINE GERBER®
SHOWER CARTRIDGE**

W-R#	Description	For Series
GB503	"Safetemp II" Cartridge & Control for GS-105	95-152 & 4



GB506

5"

**GENUINE GERBER®
SHOWER CARTRIDGE**

W-R#	Description	For Series
GB504	Pressure Balance Cartridge & Control for GH-301	97-231
GB506	Pressure Balance Cartridge & Control for GH-305	97-232



GB504

5 3/4"

GERBER.



GERBER.

**GENUINE GERBER®
SHOWER CARTRIDGE**

W-R#	Description	For Series
GB505	Cartridge for GS-305	97-058



GERBER.

**GENUINE GERBER®
SHOWER HANDLE**

W-R#	Description	Gerber#
OGP40	"Safetemp"	97-020
OGP42	"Hardwater"	97-021

- Safetemp Broach is Oval
- Hardwater Broach is Square



GERBER.

**GENUINE GERBER®
CERAMIC CARTRIDGE**

W-R#	Description	Gerber#
OGP01	Ceramaflow®	92-298

- For Single-Lever faucets & showers



**GENUINE GERBER®
TRIM PLATE**

W-R#	Description	Gerber#
OGP20	"Safetemp"	97-018

GENUINE GERBER® PARTS

GERBER®

PROFESSIONAL PERFORMANCE



GENUINE GERBER® SINGLE-LEVER SCREW PACK

W-R#	Description	Gerber#
OGP45	Screw Assortment	97-016



GENUINE GERBER® COMPRESSION BASIN STEMS

W-R#	Description	Gerber#
OGP06	Hot Stem	98-688
OGP08	Cold Stem	98-689



GENUINE GERBER® COMPRESSION SHOWER STEMS

W-R#	Description	Gerber#
OGP10	Hot Stem	98-673



GENUINE GERBER® COMPRESSION DIVERTER STEM

W-R#	Description	Gerber#
OGP14	Diverter	98-726



GENUINE GERBER® CERAMIC SHOWER STEMS

W-R#	Description	Gerber#
OGP16	Hot Stem	98-705
OGP18	Cold Stem	98-709



GENUINE GERBER® TUB/SHOWER FACE PLATES

W-R#	Description	Gerber#
OGP32	Trip Plate w/Spring	97-130
OGP34	2-Hole Blank Plate	97-305



GENUINE GERBER® PLATE & LINKAGE

W-R#	Description	Gerber#
OGP30	Plug Linkage	97-171KT
OGP31	Spring Linkage	97-172KT



GENUINE GERBER® BOTTOM ARM & PLUG

W-R#	Description
OGP36	Plug and Arm Assembly

GENUINE AMERICAN STANDARD® PARTS

American Standard



American Standard

GENUINE AMERICAN STANDARD® SINGLE-LEVER CARTRIDGES

W-R#	Description	AM STD#
AS502	Ceramic Cartridge	023529-0070A
AS504	Ceramic Cartridge	A951470-0070A



AS520
Plastic
Cadet



AS522
with Broach



AS526
Ceramic
Cadet



AS528
less Broach

American Standard

GENUINE AMERICAN STANDARD® TWO-HANDLE CARTRIDGES

W-R#	Description	AM STD#
AS520	Plastic Cartridge	A954120-0070A
AS522	Ceramic Cartridge	028610-0070A
AS526	Ceramic Cartridge	951764-0070A
AS528	Ceramic Cartridge	994053-0070A



AS510



AS512



AS524

American Standard

GENUINE AMERICAN STANDARD® SHOWER CARTRIDGES

W-R#	Description	AM STD#
AS510	Shower Cartridge	051337-0070A
AS512	Shower Cartridge	066269-0070A
AS524	Shower Cartridge	A954440-0070A



American Standard

GENUINE AMERICAN STANDARD® PRESSURE BALANCE CONTROL

W-R#	Description	AM STD#
AS514	Pressure Balance	M952100-0070A



AS630



AS634

American Standard

GENUINE AMERICAN STANDARD® FLUSHVALVES

W-R#	Description	AM STD#
AS630	1.6 GPF Flushvalve	047107-0070A
AS634	Champion 4 Tower	3174.002-0070A

SPECIALTY WASHERS



SEALTITE

**RED SEALTITE®
FAUCET WASHERS**



FLAT#	BEVELLED#	Size	Min
2702500	2702600	Asst'd	1 bx
2702502	2702602	00	1 bx
2702504	2702604	0	1 bx
2702506	2702606	1/4	1 bx
2702508	2702608	1/4 L	1 bx
2702510	2702610	3/8	1 bx
2702514	2702614	3/8 L	1 bx

- 100 washers per box
- 90 Durometer hardness; Temp up to 170°F
- Made in USA

**BLACK
NEOPRENE WASHERS**



FLAT#	BEVELLED#	Size	Min
2702000	2701000	Asst'd	100
2702002	2701002	0	100
2702004	2701004	00	100
2702006	2701006	1/4	100
2702008	2701008	1/4 L	100
2702010	2701010	3/8	100
2702012	2701012	3/8 M	100
2702014	2701014	3/8 L	100
2702016	2701016	1/2	100
2702018	2701018	1/2 L	100

- Packed 100 to a plastic container
- 80 durometer hardness



**"CROWN" PACK
WASHERS & SCREWS**

"HOME-PACK"

W-R#	Description	Min	Ctn
2706002	Beveled	1	12
2706004	Flat	1	12

- Includes 24 plastic boxes of washers and brass screws. Each box contains 20 washers and 4 brass screws.



**NEOPRENE
WASHER KIT**

W-R#	Description	Min	Box
2703002	Beveled	1	10
2703004	Flat	1	10

- Includes 200 neoprene faucet washers and 50 brass screws.



**JUNIOR NEOPRENE
WASHER KIT**

W-R#	Description	Min	Box
2704002	Beveled	1	10
2704004	Flat	1	10

- Includes 100 neoprene faucet washers and 18 brass screws.

SPECIALTY WASHERS



**PREMIUM GERBER
HOMEPACK**

W-R#	Description	Min.	Box
2705002	Flat	12	12

4 pcs - 1/4L Flat sealtite washers
4 pcs - 3/8 x 10/24 brass bibb screws



**RUBBER SLIP JOINT
WASHER**

W-R#	Description	Min.	Box
2707002	1 1/4"	100	
2707004	1 1/2"	100	
2708004	1 1/2" Heavy Duty	100	
2707008	2"	25	
2707010	2" x 1 1/2"	25	
2707006	1 1/2" x 1 1/4" Flat	100	
2708006	1 1/2" x 1 1/4" Bev	100	



**NYLON SLIP JOINT
WASHER**



W-R#	Description	Min.	Box
2708502	1 1/4"	100	100
2708504	1 1/2"	100	100
2708506	1 1/2" x 1 1/4"	100	100
2708508	2"	25	100



**NYLON TAILPIECE
WASHERS**



W-R#	Description	Min.	Box
2708602	1 1/2" Flanged	100	100



**W-R "PREMIUM" SLIP
JOINT WASHERS**

W-R#	Description	Min
2708802	1 1/4" Slip-Joint	100
2708804	1 1/2" Slip-Joint	100
2708808	1 1/2" x 1 1/4" Slip-Jt	100
2708806	1 1/2" Tailpiece	100

- Premium silicon rubber composite for better seal!



**CLOTH-INSERTED
WASHER**



W-R#	Description	Min
2735102	1 1/2" Cloth-inserted	100

SPECIALTY TOOLS



**GENUINE
CHANNELLOCK®
TONGUE & GROOVE
PLIERS**



W-R#	Size	Channellock#	Box
CL002	6 1/2"	426	6
CL004	9 1/2"	420	6
CL006	10"	430	6
CL008	12"	440	6
CL010	16"	460	6



**SOFT-JAW
WATER PUMP PLIERS**

W-R#	Description	Min	Box
1818610	10" Soft-Jaw	1	6

- Replaceable plastic jaws do not mar chrome finish!
- Furnished with spare set of jaws



**ANGLE NOSE PLIERS
-YELLOW GRIPS-**



Features
Grip-Tite Clip!

W-R#	Description	Min	Box
1818620	10"	1	10
1818624	6 3/4"	1	10
1818632	10" Smooth Jaw	1	10

- Zinc Dichromate finish resists corrosion
- Angled Pipe Wrench teeth for maximum grip
- Made in USA

PIPE TAPS



W-R#	Description	Drill Size	Box
1820002	1/8"	11/32"	5
1820004	1/4"	7/16"	5
1820006	3/8"	9/16"	5
1820008	1/2"	3/4"	1
1820010	3/4"	7/8"	1
1820012	1"	1 1/8"	1
1820014	1 1/4"	1 1/2"	1
1820016	1 1/2"	1 3/4"	1
1820018	2"	2 1/4"	1

SCREW EXTRACTORS



W-R#	Description	Drill Size	Box
1843002	#4 -- 1/8"	1/4"	5
1843004	#5 -- 1/4"	17/64"	5
1843006	#6 -- 3/8"	13/32"	1
1843008	#7 -- 1/2"	17/32"	1
1843010	#8 -- 3/4"	13/16"	1
1843012	#9 -- 1"	1 1/8"	1

SPECIALTY TOOLS



HARBORFORGE

**LP-EZ
4-WAY SCREW
EXTRACTOR**



W-R#	Description	Min	Box
1817045	4-way Screw Extractor	1	6

- Heavy Duty Carbon Steel
- Contains sizes 1/2", 3/8", 1/2", & 3/4" all in one convenient tool



HARBORFORGE

**LP-EZ
4-IN-1 WRENCH FOR
SYMMONS**



W-R#	Description	Min	Box
1817040	4-in-1 Wrench for Symmons	1	6

- Heavy Duty Carbon Steel
- Removes Diverter Cap
- Extracts Diverter Stem
- Removes Hot & Cold Seats



**"SAFETY-GRIP" UTILITY
KNIFE**

W-R#	Description	Min	Box
1812108	Safety-Grip	1	6



**HEAVY-DUTY BLADES
FOR UTILITY KNIFE**

W-R#	Description	Min	Box
1812102	Blades	5	100



**SNAP-OFF UTILITY
KNIVES**



W-R#	Description	Min	Box
1812105	Small (9 mm)	1	12
1812107	Large (18 mm)	1	12



**MINI HACKSAW
MINI HACKSAW
BLADES**

W-R#	Description	Min	Box
1812208	Mini Hacksaw	1	10

W-R#	Description	Min	Box
1812210	Blades	10	100

SPECIALTY TOOLS



INTERNAL PIPE WRENCH

W-R#	Description	Min	Box
1818122	1/2"	1	6
1818124	3/4"	1	6

- Tool to remove nipples, eccentric action grips inside of pipe.



IRWIN SPEEDBOR '2000'® WOOD BORING BITS

“Lock’n Load” Quick-Change System



W-R#	Description	Irwin #	Min	Box
1812514	5/8"	88810	1	6
1812518	3/4"	88812	1	6
1812522	7/8"	88814	1	6
1812526	1"	88816	1	6
1812528	1 1/8"	88818	1	6
1812530	1 1/4"	88820	1	6
1812532	1 3/8"	88822	1	6
1812534	1 1/2"	88824	1	6

W-R#	Description	Irwin #	Box
1812542	12" Lock'n Load	90112	1



BOSCH® “RAPIDO” GRINDER WHEELS

W-R#	Description	Min	Box
1812800	TCW1S450	12	12

- 4 1/2" x .04" x 7/8"
 - For metal/stainless steel
 - Type 1A for cutting only
 - Max RPM 13,280

DRYWALL JAB SAWS



W-R#	Description	Min	Box
1812502	Cushion Grip	1	12
1812504	Wood Handle	1	12

- Cuts through drywall, wood, & plastic
 - Designed for plunge cuts



GLASS SCRAPERS



W-R#	Description	Min	Box
1812110	Glass Scraper	1	10

- Used to scrape paint from glass, tile, metal and other hard surfaces.
 - Includes 5 replacement blades

SPECIALTY TOOLS



PROFESSIONAL RATCHETING COPPER TUBING CUTTER

W-R#	Description	Min	Box
1807026	1/4" - 2"	1	6
1807030	Wheel only	1	1

- Spring loaded cutter wheel arm
- Aluminum alloy body
- Extra wheel



PROFESSIONAL MINI-TUBING CUTTER

W-R#	Description	Min	Box
1807020	5/8"-1 1/8"	1	6
1807030	Wheel only	1	1

- Aluminum alloy body
- Extra wheel



COPPER TUBE BENDING SPRINGS

W-R#	Description	Min	Box
1806004	3/8" O.D.	1	6

- For bending supply lines and copper tubing.



PVC PIPE CUTTER

W-R#	Description	Min	Box
1812028	1" Sch 40 Cutter	1	6

- Ratchet action
- Cuts up to 1" Sch. 40 PVC pipe
- Cuts up to 1 1/4" PVC Tubular
- Harbor Forge display carded



"PVC-PRO" PVC PIPE CUTTERS

W-R#	Description	Min	Box
1812090	1" PVC Pro Cutter	1	6
1812095	2" PVC Pro Cutter	1	6

1812091 1" Replacement Blade
1812096 2" Replacement Blade

- Ratchet action
- Cuts up to 1" Sch. 40 PVC pipe
- Cuts up to 1 1/4" PVC Tubular
- Harbor Forge display carded



PEX TUBING CUTTER

W-R#	Description	Min	Box
1812040	1 1/2" OD	1	6

- Sharp cutting edge for PEX & vinyl tubing
- Harbor Forge display carded

SPECIALTY TOOLS



“QUICK-DRAW” PVC SAW



W-R#	Description	Min	Box
1812302	8” “Quick Draw”	1	12
1812310	12” “Quick Draw”	1	12
1812304	8” Blade Only	1	1
1812312	12” Blade Only	1	1

- Harbor Forge display carded



PVC INSIDE PIPE CUTTER WITH ABRASIVE WHEEL

W-R#	Description	Min	Box
1812030	Abrasive Cutter	1	12
1812032	Set of 3 Wheels	1	1



PVC INSIDE CUTTER WITH METAL WHEEL

W-R#	Description	Min	Box
1812070	Metal Blade	1	12

- Harbor Forge display carded



PVC CABLE SAW

W-R#	Description	Min	Box
1812212	26” Cable Saw	1	6

- Harbor Forge display carded



“FITT’N SAVER” PVC SOCKET REAMER

1. Saw PVC flush with fitting



2. Ream remainder out to renew fitting



W-R#	Description	Min	Box
1812060	1 1/2” Fitt’n Saver	1	6
1812062	2” Fitt’n Saver	1	6
1812064	3” Fitt’n Saver	1	6
1812066	4” Fitt’n Saver	1	6

- Harbor Forge display carded

SPECIALTY TOOLS



BLOCK FLARING TOOL

W-R#	Description	Min	Box
1808004	3/16" - 5/8"	1	6
- 3/16", 1/4", 5/16", 3/8", 7/16", 1/2", 5/8"			
- Harbor Forge display package			



COPPER SWEDGE TOOL

W-R#	Description	Min	Box
1808215	3/8" - 7/8"	1	6



WIRE-HANDLE COPPER FITTING BRUSH

W-R#	Description	Min	Box
1809002	3/8"	10	100
1809004	1/2"	10	100
1809006	3/4"	10	100
1809008	1"	10	100
1809010	1 1/4"	10	100
1809012	1 1/2"	10	100
1809014	2"	10	100



PLASTIC-HANDLE COPPER FITTING BRUSH

W-R#	Description	Min	Box
1811002	3/8"	10	100
1811004	1/2"	10	100
1811006	3/4"	10	100
1811008	1"	10	100
1811010	1 1/4"	10	100
1811012	1 1/2"	10	100
1811014	2"	10	100



4-IN-1 COPPER FITTING BRUSH

W-R#	Description	Box
1809000	1/2" X 3/4" Brush	1
- Harbor Forge display carded		



LONG-HANDLE WIRE SCRATCH BRUSH

W-R#	Description	Min	Box
1811102	Scratch Brush	1	10
- 3 x 19 rows			
- 13" long			

SPECIALTY TOOLS



**BLUE WATERPROOF
EMERY CLOTH**

W-R#	Description	Min	Box
1835000	5 yard	1	25
1835002	10 yards	1	25
1835004	25 yards	1	25

- 1½" Wide, 120 grit



**OPEN-MESH GRIT
CLOTH**

W-R#	Description	Min	Box
1835006	5 yards	1	25
1835008	10 yards	1	25

- Waterproof 180 grit



**"CROWN-BRITE"
ABRASIVE HAND PADS**

W-R#	Description	Min	Box
1847500	6" x 9 1/2" pad	60	60

• A quality substitute for the Scotch Brite® pad.



SCOTCH BRITE® PADS

W-R#	Description	Min	Box
1848000	6" x 9½" pad	20	60
1848001	6" x 9½" pad	60	60



**#0 INDUSTRIAL
STEEL WOOL PADS**

W-R#	Description	Min	Box
2433002	6 sleeves/ctn	1	1

- 16 large pads per sleeve
- "0" size.



DOPE BRUSH

W-R#	Description	Min	Box
1813002	3/8"	36	36



ACID BRUSHES

W-R#	Description	Min	Box
1812002	1/4"	1 gr.	1 gr.



**WOOD HANDLE CHIP
BRUSHES**

W-R#	Description	Min	Box
1814002	1"	10	10
1814006	2"	10	10
1814008	3"	10	10



SPECIALTY TOOLS

5/8" CAULKING IRONS



W-R#	Description	Min	Box
1872002	Inside - Short	1	6
1872004	Outside - Short	1	6
1872006	Straight - Short	1	6
1872012	Broad-Nose	1	6



STEEL SOLDER LADLE

W-R#	Description	Min	Box
1804006	4"	1	6



CAST IRON SOLDER POT

W-R#	Description	Min	Box
1805006	8"	1	6



OAKUM



W-R#	Description	Min	Box
1804048	Brown (1# bag)	1	6
1804050	Brown (5# box)	1	10
1804054	White (5# bag)	1	10



LEAD INGOTS



W-R#	Description	Min	Box
2444002	5 lb ingot	1	Strip

- 25 lb strip = handle & 4 plugs

- For sealing cast iron caulk joints
- Sold in 5 lb plugs. Packaged in 25 lb strips



LEAD WOOL



W-R#	Description	Min	Box
2444004	5 lb box	1	25

- For sealing cast iron caulk joints



NON-ASBESTOS JOINT RUNNER



W-R#	Description	Min	Box
1823002	#1 (2" to 4")	1	6
1823004	#2 (4" to 6")	1	6
1823006	#3 (6" to 10")	1	6
1823008	#4 (10" to 14")	1	6

SPECIALTY TOOLS



PLUMBERS CANDLES

W-R#	Description	Min	Box
1840002	Candles	1	120



SPARK LIGHTER

W-R#	Description	Min	Box
1848002	Round File	1	10
1848006	Flat File	1	10

REPLACEMENT FLINTS

1848004	Flint only	10	10
---------	------------	----	----



"TRIPLE-HEAD" STRIKE LIGHTER



W-R#	Description	Min	Box
1848010	Triple Strikers	1	10
1848012	Triple Flint	5	5



FLAME SHIELD PADS



W-R#	Description	Min	Box
1905000	12" x 12" Pad	1	12

- Fire Proof Non asbestos material protects wood and metal during sodling and brazing.
- Aluminum backing holds shape
- Working temp: 2500 °F



B-TANK KEYS

W-R#	Description	Min	Box
1701210	B-Tank Key	12	12



SOAPSTONES

W-R#	Description	Min	Box
1848510	Flat (6 per pack)	6	12
1848502	Flat Holder Only	1	6



KWICK-WICK SPOOLS



W-R#	Description	Min	Box
1906004	Spool	25	400

- Individual spools of single strand wicking for packing in threaded joints.



2 OZ. LAMPWICK BALLS



W-R#	Description	Min	Box
1906018	Fine (5-end)	12	12
1906020	Medium (8-end)	12	12

SPECIALTY TOOLS



ELECTRICAL TAPE

W-R#	Description	Min	Box
1841002	3/4" x 60'	1	10



BLUE PAINTER'S TAPE

W-R#	Description	Min	Box
1004102	1" Wide	1	10
1004104	1 1/2" Wide	1	10
1004106	2" Wide	1	10



DUCT TAPE



W-R#	Description	Min	Box
2426002	2" x 60 yds-Gray	1	24
2426003	2" x 60 yds-Black	1	24



FOIL TAPE

W-R#	Description	Min	Box
2426010	2" x 60 Foil	1	12



CLEAR PLASTIC SHEETING

W-R#	Description	Thickness
1924050	10' X 100'	4 mil

- Clear polyethylene sheeting for a multitude of construction & surface protection applications.



CLEAR PLASTIC DROPCLOTHS

W-R#	Description	Min	Box
1924002	9' X 12' (1 mil)	1	12

- Clear polyethylene dropcloth



CANVAS DROPCLOTHS



W-R#	Description	Min	Box
1924010	9' X 12' (8 oz)	1	12

- Medium-duty canvas dropcloth



RED ROSIN PAPER

W-R#	Description	Min
1921002	36" x 167'	1

- General purpose surface protection paper

SPECIALTY TOOLS



**BROWN JERSEY
WORK GLOVES**

W-R#	Description	Min	Box
1839002	Brown Jersey	1 dz	12 dz
- 9 oz.			



**"SPLATTER-PALM"
WORK GLOVES**

W-R#	Description	Min	Box
1839008	Red "Splatter"	10 pr	100 pr



LATEX GLOVES

W-R#	Description	Min	Box
1839060	Large	50 pr	50 pr
- Powdered white latex			



WHITE VINYL GLOVES

W-R#	Description	Min	Box
1839049	Extra Large	50 pr	50 pr
- Powdered white vinyl			



**CLEAR POLYETHYLENE
GLOVES**

W-R#	Description	Min	Box
1839050	Large	50 pr	50 pr
- Clear polyethylene gloves for food service and light commercial applications.			



BLUE NITRILE GLOVES

W-R#	Description	Min	Box
1839051	Large	50 pr	50 pr
1839053	Extra Large	50 pr	50 pr



**BLACK NITRILE
GLOVES**

W-R#	Description	Min	Box
1839065	Small	50 pr	50 pr
1839057	Large	50 pr	50 pr
1839059	Extra Large	50 pr	50 pr

SPECIALTY TOOLS



**GREASE MONKEY®
“GORILLA-GRIP”
NITRILE GLOVES**



W-R#	Description	Min	Box
------	-------------	-----	-----

1839702	Large	1 pr	12 pr
1839704	Extra Large	1 pr	12 pr

- Patented NeverSlip® technology
- Lightweight nylon shell
- Nitrile dipped for maximum durability during wet & dry projects.



**SHOWA ATLAS 300®
HEAVY-DUTY
RUBBER GRIP WORK
GLOVES**



W-R#	Description	Min	Box
------	-------------	-----	-----

1839302	Large	1 pr	12 pr
1839304	Extra Large	1 pr	12 pr

- Natural rubber palm coating
- Comfortable, breathable cotton polyester liner
- Rough textured for maximum grip
- Elastic knit wrist cuff



**HEAVY-DUTY
“GRIPP-CHIPP”
RUBBER WORK
GLOVES**



W-R#	Description	Min	Box
------	-------------	-----	-----

1839072	XL	1 pr	12 pr
----------------	----	------	-------

- Heavy-duty construction
- Jersey-lined for comfort
- Rubber-like chips for grip



**UGLY-GLOVE®
PVC-CHIP COATED
ROOTER GLOVES**



W-R#	Description	Min	Box
------	-------------	-----	-----

1839070	XL	1 pr	12 pr
----------------	----	------	-------

- Heavy-duty construction
- Jersey-lined for comfort
- PVC chips allow for handling pipe cable without friction burn or binding.



**SHU-BEE® ORIGINAL
SHOE COVERS**



W-R#	Description	Min	CTN
------	-------------	-----	-----

1839102	Dark Blue	1 bx (100)	3 bx
1839104	Red	1 bx (100)	3 bx

- The original shoe cover for professionals
- Prevents tracking dirt/dry debris in client's homes
- Stronger than other disposable shoe covers
- One size fits most

SPECIALTY TOOLS



**DISPOSABLE KN95
DUST MASKS**

W-R#	Description	Min	Box
1839559	KN95 Dust Mask	1	50



**PROTECTIVE EYE
GUARD**

W-R#	Description	Min	Box
1839510	Vinyl Goggles	1	12



CLEAR SPECTACLES

W-R#	Description	Min	Box
1839511	Clear	1	12

- 100% Impact resistant
- Absorbs 99% UV light



**JACKSON "NEMESIS"®
SAFETY GLASSES**

W-R#	Description	Min	Box
1839602	Clear	1	12
1839604	Smoke-Mirrored	1	12
1839606	Blue-Mirrored	1	12
1839608	Camo-Bronze	1	12

- Meets ANSI Z87.1+ standard
- Polycarbonate lenses provide 99.9% UVA/ UVB/ UVC protection



**DISPOSABLE SMS
POLYPROPYLENE
COVERALLS**

W-R#	Description	Min	Box
1839532	Medium	1	25
1839534	Large	1	25
1839536	Extra Large	1	25

- Full zip with collar
- Elastic cuffs
- Less hood & boots



**CONTRACTOR
SAFETY VESTS**

W-R#	Description	Min	Box
1839802	Orange	1	12

- Red Orange Vinyl coated polyester mesh
- Flexible knit for comfort
- Lime/yellow reflective strips for night visibility
- UV-resistant

SPECIALTY TOOLS



WHITE HARDHATS

W-R#	Description	Min	Box
------	-------------	-----	-----

1839820 White 1 20

- White HDPE shell
- 4 point suspension with pin lock
- Meets ANSI Z89.1-2009 Type 1 Class E



HEARING PROTECTOR EARMUFFS

W-R#	Description	Min	Box
------	-------------	-----	-----

1839832 Low Profile 1 6

- Padded foam headband
- Noise Reduction Rating (NRR) 27
- Professional grade



CORDED EARPLUGS

W-R#	Description	Min	Box
------	-------------	-----	-----

1839834 AirSoft design 1 6

- 4-flange AirSoft design for comfort & protection
- Noise Reduction Rating (NRR) 27
- Includes carrying case



5-PACK FOAM EARPLUGS

W-R#	Description	Min	Box
------	-------------	-----	-----

1839836 Single-use 1 6

- Bell-shaped polyurethane foam
- Noise Reduction Rating (NRR) 33
- 5 pair per pack



FIRST AID KITS

W-R#	Description	Min	Box
------	-------------	-----	-----

1839872 10-person kit 1 5

- White plastic case
- Contains: (16) 1" x 3" Adhesive Bandages, (1) 1/2" x 5 yd. Adhesive Tape, (1) Instant Cold Pack, (1) 3" x 6 yd. Roller, (1) Non-Sterile Triangular Bandage, (1) Plastic Forcep, (1) Scissor, (1) 5" x 9" Sterile Trauma Pad, (2) Sterile Eye Pads, (4) Synthetic Gloves, (2) 3 Packs Pain-A-Rest(R), (4) 3" x 3" Sterile Gauze Pads, (6) Antibiotic Ointment, (6) Burn Cream, (6) Antiseptic, (6) Sting Packs



GRABBER® HAND & TOE WARMERS

W-R#	Description	Min	Box
------	-------------	-----	-----

1839882 Hand Warmers 12 40

1839884 Toe Warmers 12 40

- Single-use air activated heat packs

SPECIALTY TOOLS



STUFF-SORTER® ORGANIZER BUCKETS



W-R#	Description	Min	Box
1861000	Bucket (2 lg, 2 sm trays)	1	8
1861004	Small Tray only	1	6
1861006	Large Tray only	1	6



WHITE 5 GALLON BUCKET



W-R#	Description	Min	Box
1861010	5 Gallon Bucket	1	6



PLASTIC UTILITY TOTE TRAYS



W-R#	Description	Min	Box
1862050	Tote Tray	1	6

- Black Plastic
- 10" x 15" x 5"



STEEL NIPPLE TRAYS

W-R#	Description	Min	Box
1871002	1/2"	1	1
1871004	3/4"	1	1
1871006	1"	1	1
1871008	1 1/4"	1	1
1871010	1 1/2"	1	1
1871012	2"	1	1
1871500	1/2" x 3/4"	1	1



DRAIN-KING® DRAIN CLEANERS

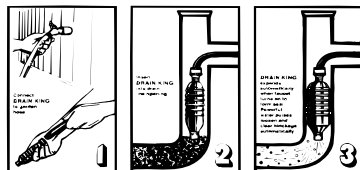

W-R#	Description	Drain King#	Min
1821000	1"-2"	501	1
1821002	1 1/2" - 3"	186	1
1821003	3" - 4"	H34	1
1821004	3" - 6"	750	1

SPECIALTY TOOLS



BLOCKAGE BUSTER

W-R#	Description	Min	Box
1830006	25'	1	4



ZOOM AUGER

W-R#	Description	Min	Box
1831504	1/4" x 25'	1	4

- One piece cork screw head. Tough plastic housing.



"MASTER" FORCE CUP W/STICK

W-R#	Description	Min	Box
1825004	W/ pullout sleeve	1	12

- 18" stick



RUBBER FORCE CUP W/STICK

W-R#	Description	Min	Box
1826002	4" (9" stick)	1	12
1826004	5" (24" stick)	1	12
1826006	6" (24" stick)	1	12



"ULTRA-BLAST" FORCE CUP W/STICK

W-R#	Description	Min	Box
1825030	"Ultra-Blast" w/ pullout sleeve	1	12

- 18" stick



"PRO-FORCE" FORCE CUP W/STICK

W-R#	Description	Min	Box
1825020	"Pro-Force" w/ pullout sleeve	1	12

- 18" stick

SPECIALTY TOOLS



**BALL-TYPE FORCE CUP
W/STICK**

W-R#	Description	Min	Box
1825002	With 24" stick	1	4



**HIGH-NECK VENT
PLUNGER W/STICK**

W-R#	Description	Min	Box
1825006	High-Neck	1	12

- Used to clear external house traps
- Popular for use in Michigan & Buffalo, NY



**4" STACK PLUNGER
HOLDER & DISC**



W-R#	Description	Min	Box
1825050	1/2" Holder Only	1	6
1825052	4" Rubber Disc	1	6

- Force disc plunger for cast iron soil & vent lines
- Brass holder fits 1/2" pipe
- Nylon-reinforced rubber disc



**"HANDY HAND"
PICK-UP TOOL**

W-R#	Description	Min	Box
1824504	24"	1	6



**GT WATERS
FLEXIBLE
MINI-SNAKE**

W-R#	Description	Min	Box
1829001	Mini-Snake	1	12

- Round polypropylene shaft won't kink or bend.



**4-PIECE DENTAL
PICK SET**

W-R#	Description	Min	Box
1845004	4 pc. Set	1	6

- Useful for removing stubborn o-rings, & stem packing



O-RING PULLER

W-R#	Description	Min	Box
1845002	5 1/4"	1	6

- For easy removal of all size "O" rings and washers.

SPECIALTY TOOLS

HARBORFORGE



What are HarborForge tools?

HarborForge is Wal-Rich’s line of plumbing specialty tools attractively packaged and retail-ready. Furnished in professionally designed slide-blister--HarborForge tools are barcoded and pegboard ready to give your sales counter a more polished look.

With over 25 SKUs available, and more being added--consider HarborForge tools for your sales counter.



Look for the **HARBORFORGE** logo on the following items:

- | | |
|---|--|
| 1812028 1" PVC Pipe Cutter (p.225) | 1824002 Handle Puller (p.239) |
| 1812040 PEX Tubing Cutter (p.225) | 1824008 Yank-All Handle Puller (p.239) |
| 1812302 8" Quickdraw Saw (p.226) | 1824010 Tri-Jaw Handle Puller (p.239) |
| 1812310 12" Quickdraw Saw (p.226) | 1849000 Cartridge Puller for Moen (p.239) |
| 1812212 26" PVC Cable Saw (p.226) | 1849001 T-Handle Puller for Moen (p.239) |
| 1812060 1 1/2" Fitt'n Saver (p.226) | 1818400 Crown Tub Drain Wrench (p.240) |
| 1812062 2" Fitt'n Saver (p.226) | 1818005 4-in-1 PO Plug Wrench (p.240) |
| 1812064 3" Fitt'n Saver (p.226) | 1817002 Duo Spanner Wrench (p.240) |
| 1812066 4" Fitt'n Saver (p.226) | 1818106 Shower Body Socket Set (p.241) |
| 1812070 PVC Inside Cutter (p.226) | 1818135 Folding Hex Keys (p.242) |
| 1808004 Block Flaring Tool (p.227) | 0421004 4-way sillcock key (p.243) |
| 1809000 4-in-1 Fitting Brush (p.227) | 1817010 Telescoping Basin Wrench (p.243) |
| 1818500 No-Hub Torque Wrench (p.244) | 1802210 Inspection Mirror (p.247) |

SPECIALTY TOOLS



STANDARD HANDLE PULLER

W-R#	Description	Min	Box
1824002	Standard	1	6

- Harbor Forge display carded



HAMMER-ACTION HANDLE PULLER

W-R#	Description	Min	Box
1824004	Deluxe (Hammer)	1	6



W-R "YANK-ALL" HANDLE PULLER

W-R#	Description	Min	Box
1824008	"Yank-All"	1	6

- Wider jaws fit over larger shower handles
 - Harbor Forge display carded



W-R "TRI-JAW" HANDLE PULLER

W-R#	Description	Min	Box
1824010	"Tri-Jaw"	1	6

- 3 adjustable jaws to fit the most stubborn handles.
 - HarborForge display carded



MOEN CARTRIDGE REMOVAL TOOL

W-R#	Description	Min	Box
1849000		1	1

- For removal of both metal and plastic Moen faucet cartridges.
 - HarborForge display carded



MOEN CARTRIDGE REMOVAL TOOL

W-R#	Description	Min	Box
1849001	T-handle	1	1

- An alternative to the gold key pattern for removal of plastic and brass Moen cartridges.
 - HarborForge display carded

SPECIALTY TOOLS



CROWN TUB DRAIN WRENCH

W-R#	Description	Min	Box
1818400		1	6

- Cast Aluminum Body
- Fits most tub drains and spuds
- Harbor Forge display carded



P.O. PLUG WRENCH

W-R#	Description	Min	Box
1818004	Wrench	1	6



4-1 P.O. PLUG WRENCH

W-R#	Description	Min	Box
1818005	4 in 1 Wrench	1	6

- Harbor Forge display carded



INTERNAL SPUD WRENCH

W-R#	Description	Min	Box
1818000	Internal Wrench	1	6

- Non-Mar wrench can be used for removal or installation of closet spuds, large and small sink strainers, waste and overflows, etc.
- Harbor Forge display carded



4-IN-1 LOCKNUT WRENCH

W-R#	Description	Min	Box
1818142	Wrench	1	6

- Fits all size closet spuds and duo locknuts.



ADJUSTABLE LOCKNUT WRENCH

W-R#	Description	Min	Box
1818144	Locknut wrench	1	6



DUO STRAINER SPANNER WRENCH

W-R#	Description	Min	Box
1817002	Wrench	1	6

- For tightening locknut of duo strainer and sink plug. Cast Body.



INSIDE DUO BASKET WRENCH

W-R#	Description	Min	Box
1817003	Inside Wrench	1	6

- 4" length

SPECIALTY TOOLS



CUP-TYPE DUO STRAINER WRENCH

W-R#	Description	Min	Box
1818146	Cup-Type Wrench	1	6

- High Impact Black Plastic



SHOWER BODY SOCKET WRENCH SET

W-R#	Description	Min	Box
1818106	7 piece set	1	25

- Consists of 5 two size sockets. For use on shower valves, faucets, bibbs and basin cocks, etc. Total pieces = 7.
- Harbor Forge display package



INDIVIDUAL SHOWER SOCKETS

W-R#	Description	Min
1818108	21/32" x 27/32"	1
1818110	29/32" x 31/32"	1



HEAVY-DUTY DOUBLE-END SHOWER SOCKET WRENCH

W-R#	Description	Min
1818008	For Savoy	1
1818010	For Gerber	1

- For bonnet and packing bushings and behind the wall concealed bath and shower fixtures.



SEAT WRENCH

W-R#	Description	Min	Box
1818126	Straight	1	12
1818128	Angle	1	12

• A forged steel tool to exact most all sizes of faucet seats. Features smooth, tapered ends.



GERBER SEAT WRENCH

W-R#	Description	Min	Box
1818130	F/ Gerber seats	25	25



"CROWN" RATCHET SEAT WRENCH SET

W-R#	Description	Min	Box
1818134	Ratchet wrench	1	12

• A 4-piece tool that fits most faucet seats. Packed in a pouch. Features smooth, tapered ends.

SPECIALTY TOOLS



**O'MALLEY
"DRIPSTOPPER"
FAUCET RESEATER**



W-R#	Description	Min	Box
1816010	Drip stopper • Drip stopper set includes four hardened steel cutters, faucet washers, and guide cone for repairing faucets without cap nuts.	1	6
1816011	Shower Reamer - Special Design for Shower seats - Longer shaft to enter shower body	1	6



**BRASS-CONE
BIBB REAMER**

W-R#	Description	Min	Box
1816002	Reamer - Furnished with extra cutting heads.	1	6



STRAP WRENCH

W-R#	Description	Min	Box
1817016	7" handle	1	6



**TOILET SEAT
NUT WRENCH**

W-R#	Description	Min	Box
1817004	Nut wrench - Fits all types of nuts used on toilet seat hinges, plastic or metal.	1	6



FOLDING HEX KEY SET

W-R#	Min	Box
1818135	1	6

- Harbor Forge display carded



**T-HANDLE HEX
KEY SET**

W-R#	Size	Min	Box
1818137	9"	1	6

- 8 piece set



**8 PIECE ALLEN
WRENCH SET ON RING**

W-R#	Min	Box
1818140	1/16" to 1/4"	1 6

SPECIALTY TOOLS



Basin Buddy



**BASIN BUDDY®
FAUCET NUT WRENCH**

W-R#	Description	Min	Box
1890002	Basin Buddy	1	10

- The original Basin Buddy® Universal Faucet Nut Wrench
- Fits most metallic & plastic basin supply nuts
- Unique cutaway design allows for easy installation & removal of nuts.
- Includes 1/4" x 3/8" ratchet adapter
- Made in USA



HARBORFORGE

BASIN WRENCH

W-R#	Description	Min	Box
1817006	11"	1	6
1817008	15"	1	6

- Harbor Forge display carded



HARBORFORGE

**HEAVY-DUTY
ADJUSTABLE
BASIN WRENCH**

W-R#	Description	Min	Box
1817010	10" - 16"	1	6

- Similar to Rigid 1017
- Harbor Forge display carded



HARBORFORGE

**4-WAY
SILLCOCK KEY**

W-R#	Description	Min	Box
0421004		1	10

- Fits popular make stop cocks with stems 1/4", 9/32", 5/16" and 11/32".
- Harbor Forge display carded



**WATER HEATER
ELEMENT WRENCH**

W-R#	Description	Min	Box
1817000	Element Wrench 1	1	6

- 3" length



**RADIATOR
SPUD WRENCH**

W-R#	Description	Min	Box
1818120	Domestic	1	6
1818118	Imported	1	6

- Heavy-duty malleable iron

SPECIALTY TOOLS



NO-HUB TORQUE WRENCH

W-R#	Description	Min	Box
1818500	No-Hub Wrench 1	1	6

- 5/16" socket



CROWN DELUXE NO-HUB TORQUE WRENCH

W-R#	Description	Min	Box
1818560	60 psi Wrench 1	1	1

- 5/16" socket



NUT DRIVERS

W-R#	Description	Min	Box
1808452	5/16"	1	6



6-1 SCREW DRIVER

W-R#	Description	Min	Box
1808403	6 -1 Screwdriver 1	1	12



MAGNETIC ALUMINUM TORPEDO LEVEL

W-R#	Description	Min	Box
1858400	Johnson® Level 1	1	12



AVIATION TIN SNIPS

W-R#	Description	Min	Box
1815002	Center Snip 1	1	6



4-1 COUNTERSUNK PLUG WRENCH

W-R#	Description	Min	Box
1818148	Wrench 1	1	6

- 3/4", 7/8", 1", 1 1/4" plugs



6-1 COUNTERSUNK PLUG WRENCH

W-R#	Description	Min	Box
1818150	Wrench 1	1	1

- Malleable iron
- Fits square and slotted cleanout plugs

SPECIALTY TOOLS



**STEEL-FRAME
CAULKING GUN**

W-R#	Description	Min	Box
1840104	Steel Frame	1	12



**STANDARD
CAULKING GUN**

W-R#	Description	Min	Box
1840102	Barrel Style	1	12



RUBBER TIE DOWNS



W-R#	Description	Min	Box
1846000	15"	1	20
1846002	21"	1	20
1846004	31"	1	20
1846006	41"	1	20



NYLON CAM STRAPS

W-R#	Description	Color	Min
1846502	1" X 24"	Black	1
1846504	1" X 48"	Red	1
1846506	1" X 72"	Yellow	1
1846512	1" X 144"	Purple	1



**YELLOW
MASON TWINE**

W-R#	Description	Min	Box
1908002	#18 X 275'	1	12



**STEEL PUTTY
KNIVES**

W-R#	Description	Min.	Box
1818606	2" Putty Knife	1	12

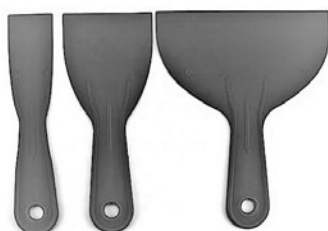

**PLASTIC PUTTY
KNIVES**



W-R#	Description	Min.	Box
1808260	1 1/2"	1	12
1808262	2"	1	12
1808264	3"	1	12
1808266	4"	1	12
1808268	6"	1	12



POINTING TROWELS

W-R#	Description	Min	Box
1808899	5" Trowel	1	10

- Philadelphia Pattern

SPECIALTY TOOLS



3 IN 1 CAULK TOOL



W-R#	Description	Min	Box
1808270	3 in 1 Caulk Tool	1	6

- For removing and smoothing freshly laid caulk
- Works with acrylic, latex and silicone caulk.

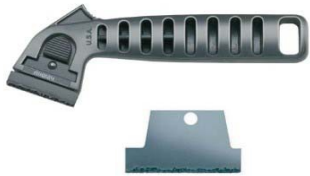

GROUT RAKE



W-R#	Description	Min	Box
1808272	Grout Rake	1	6
1808273	Replacement Blade (2pk)	1	6

- Easy push button for quick blade change
- Tungsten carbide grit blade (2 included)



CAULK REMOVAL TOOL



W-R#	Description	Min	Box
1808274	Removal Tool	1	6

- Used to open cracks in plaster or concrete
- Made of durable steel and plastic.



PLASTIC HANDLE FINISHING TROWEL



W-R#	Description	Min	Box
1808202	9" X 4"	1	6



PLASTIC HANDLE 1/4" NOTCHING TROWEL



W-R#	Description	Min	Box
1808204	9" X 4" 1/4" Square	1	6



WOOD HANDLE RUBBER FLOAT



W-R#	Description	Min	Box
1808206	9" X 4" Black	1	6



SPONGES



W-R#	Description
1881010	All-Purpose Sponge (7" x 4" x 2 1/2")
1881012	Grouting Sponge (6" X 4" X 2" Fine Pore)

SPECIALTY TOOLS

DROP LIGHTS



W-R#	Description	Min	Box
1802020	16/3 25 ft.	1	6
1802022	16/3 50 ft.	1	6

- Metal Cage
- U.L. Approved
- Orange rubber insulation

TOUGH-SKIN® COATED INCANDESCENT BULBS



W-R#	Description	Min	Box
1802125	75 Watt	6	48
1802127	100 Watt	6	48

EXTENSION CORDS



W-R#	Description	Min	Box
1802000	16/3 50 ft.	1	6
1802002	16/3 25 ft.	1	6
1802004	12/3 25 ft.	1	6
1802006	12/3 50 ft.	1	4
1802008	12/3 100 ft.	1	2

- U.L. approved
- Orange rubber insulation

GARBAGE DISPOSAL CORDS



W-R#	Description	Min	Box
1802302	3' w/straight plug	1	6
1802304	6' w/straight plug	1	6

- 16/3 AWG
- 5-15 plug
- 13A, 1625V

GARBAGE DISPOSAL CORD KITS



W-R#	Description	Min	Box
1802350	3' w/straight plug	1	6
1802352	6' w/straight plug	1	6

- Furnished with 1/2" ROMEX connector & wire nuts

ALKALINE BATTERIES



W-R#	Description	Min	Box
1819002	"D"	12	12
1819004	"C"	12	12
1819006	"AA"	24	24
1819008	"AAA"	24	24
1819010	9V	12	24

SPECIALTY TOOLS



INSPECTION MIRROR

W-R#	Description	Min.	Box
1802210	1 1/4" Round	1	6

- Telescoping arm



MATCH EXTENDER

W-R#	Description	Min.	Box
1802212	26" Extender	1	6

- Telescoping arm



5 LB. BOX OF RAGS

W-R#	Description	Box
1881002	5 lb. box	1

- Recycled Fleece Sweatshirt material



SHOP TOWELS

W-R#	Description	Bag
1881004	10 per bag	1

- Size 15" X 15"
- 100% Cotton
Highly Absorbent, Machine Washable, Recyclable.



WHITE TERRY TOWELS

W-R#	Description	Bag
1881006	8 per bag	1



WHITE KNIT RAGS

W-R#	Description	Bag
1881008	16oz Bright White Knit Rags	1



- White T-Shirt material



32 OZ SPRAY BOTTLE

W-R#	Description	Min	Box
1882050	32 oz	1	4



SPECIALTY TOOLS



**KIDDE®
CARBON MONOXIDE
DETECTOR**

W-R#	Description	Min	Box
------	-------------	-----	-----

1981002 Battery Operated 1 6

- uses 2 AA batteries
- 10 yr manufacturer warranty



**FIRST ALERT®
SLIM SMOKE ALARM**

W-R#	Description	Min	Box
------	-------------	-----	-----

1982004 Lithium 10 Yr. Internal Battery 1 6

- 10 yr manufacturer warranty



**LEAK SHREAK®
WATER ALARMS**

W-R#	Description	Min	Box
------	-------------	-----	-----

1980002 Leak Shreak® 1 10

- 95 db water leak alarm
- Uses 9v battery
- Attractive, compact design
- Ideal for single/multi-family housing!

HEAR LEAKS WHEN THEY HAPPEN WITH LEAK-SHREAK®!

**“THE LAST DROP”
SUCTION GUN**



W-R#	Description	Min
------	-------------	-----

1036002 Last Drop Suction Gun 1

- Removes water from toilet tanks and bowls
- PVC construction
- 16oz capacity
- Corrosion resistant



**WATER WOW®
ABSORBENT
GRANULES**

W-R#	Description	Min	Ctn
------	-------------	-----	-----

1019502 6 oz packet 1 12

- Superabsorbent polymer “jells” upon contact with water, making cleanup a breeze!

SPECIALTY TOOLS



WATER METER KEYS

W-R#	Description	Min
2441010	5/8" x 36"	1
2441012	3/4" x 60"	1

- Heavy-duty rebar construction
- Comfortable rubber grips



4 FOOT SOIL PROBES

W-R#	Description	Min
2442002	4' Steel Rod	1
2442010	4' Fiberglass Rod	1

- Stainless steel pointed tip
- Comfortable rubber grips



2443050
27" Mini

SHOVELS

W-R#	Material	Blade	Handle Type
2433102	Wood	Square	D-handle
2433104	Wood	Square	Long
2433202	Wood	Round	D-handle
2433204	Wood	Round	Long



2433502
Fiberglass Trench



2433302	Fiberglass	Square	D-handle
2433304	Fiberglass	Square	Long
2433402	Fiberglass	Round	D-handle
2433404	Fiberglass	Round	Long

2443050 27" Mini Shovel
2433502 Fiberglass Trenching Shovel



2433202
Wood



2433204
Wood



2433102
Wood



2433104
Wood



2433402
Fiberglass



2433404
Fiberglass



2433302
Fiberglass



2433304
Fiberglass

SPECIALTY TOOLS



AMES® HEAVY DUTY TAMPER

W-R#	Description
------	-------------

1903600	8" X 8" Steel Tamper
----------------	-----------------------------

- For packing and leveling soil, asphalt, gravel, stone, and dirt.



BLUE POLY TARPS

W-R#	Description
------	-------------

1924106	10' x 12' Tarp
----------------	-----------------------

1924110	10' x 20' Tarp
----------------	-----------------------

- Waterproof poly-tarp with metal grommets



CONTRACTOR BAGS

W-R#	Description	Thickness
------	-------------	-----------

2460002	42 Gallon (32" x 50")	3 mil
----------------	------------------------------	--------------

2460004	55 Gallon (38" x 58")	2 mil
----------------	------------------------------	--------------

- Heavy Duty cleanup bags
- 20 bags per box



CAUTION TAPE

W-R#	Description	Min	Box
------	-------------	-----	-----

2426006	3" x 1000'	1	12
----------------	-------------------	----------	-----------

2426008	3" x 300'	1	12
----------------	------------------	----------	-----------



FUNNELS

W-R#	Description	Min
------	-------------	-----

1853006	2 Quart Funnel	1
----------------	-----------------------	----------

- Plastic
- 8 1/2" x 8 1/2" x 7"



OIL-DRI® ABSORBENT GRANULES

W-R#	Description	Min	Pallet
------	-------------	-----	--------

1013002	40 lb Oil-Dri® Granules	12	40
----------------	--------------------------------	-----------	-----------

- Oil-Dri® Granular Clay Absorbents can be used on oils, coolants, grease, water and other liquid spills. These absorbents are not to be used with turpentine or vegetable oil.
- Additional shipping & handling charges apply.



SPECIALTY TOOLS



30" WRECKING BAR



W-R#	Description
1808620	3/4"x 30" Wrecking Bar



11" STEEL PRY BAR



W-R#	Description
1808622	11" Hardened Steel Pry Bar



16 OZ CLAW HAMMER



W-R#	Description	Handle
1808630	16oz Claw Hammer	Wood



12 OZ BALL PEIN HAMMER



W-R#	Description	Handle
1808632	12oz Ball-pein	Wood



16 OZ RUBBER MALLET



W-R#	Description	Handle
1808634	16oz Rubber Mallet	Wood



3 LB LUMP HAMMER



W-R#	Description	Handle
1808636	3 lb. Lump Hammer	Wood



8 LB SLEDGEHAMMER



W-R#	Description	Handle
1808638	8 lb. Sledge Hammer	Wood



15" HATCHET



W-R#	Description	Handle
1808650	15" Hatchet	Wood



34" SPLITTING AXE



W-R#	Description	Handle
1808652	34" Splitting Axe	Wood



8" FILE & RASP



W-R#	Description
1808644	4 in 1 File & Rasp

SPECIALTY CHEMICALS



**GORILLA GLUE®
MULTIPURPOSE GLUE**

W-R#	Description	Min	Box
1029002	2oz	1	10
1029004	4oz	1	8
1029006	8oz	1	6

- Original Gorilla Glue® bonds wood, stone, foam, ceramic, glass, brick, concrete, & more
- 100% waterproof
- Paintable, sandable. Makes for easy finishing



**GORILLA TAPE®
HEAVY DUTY DUCT
TAPE**

W-R#	Description	Color	Min
1033002	2" x 12yd	Black	1
1033004	2" x 35yd	Black	1
1033010	2" x 12yd	Silver	1
1033012	2" x 35yd	Silver	1

- Double Thick adhesive bonds wood, stucco, brick, & more.
- Rugged shell & backing



**O'KEEFE'S WORKING
HANDS® MOISTURIZER**

W-R#	Description	Min	Box
1034002	3.4 oz tub	1	6

- O'keeffe's® concentrated cream heals, relieves, and repairs extremely dry, cracked hands.



COLD SOLDER PASTE

W-R#	Description	Min.	Box
1007002	1½ lb can	1	12

- Versatile chemical compound used for metal glazing and filling. Applies like putty, and hardens like metal.

SPECIALTY CHEMICALS



**BLACK & WHITE®
GRAPHITE PACKING
SPOOLS**



W-R#	Description	Ft/roll	Min	Box
1900002	1/4"	8 ft	1	12
1900004	1/8"	12ft	1	12

- Non-asbestos
- Reclosable Spool



**E-Z FIX STEM
PACKING DISPLAY**



W-R#	Description	Min.	Box
1907102	Graphite	1	1
1907104	Teflon	1	1

- 3/32" X 20" Strands
- 24 to a display box.



STEM GREASE



W-R#	Description	Size
1650000	Stem Grease	1 oz
1650001	Stem Grease	2 oz

- Heat resistant
- Petroleum-based



W-R#	Description	Size
1650003	Silicon Grease	1 oz



**MSP
INDUSTRIAL WRAP®
SILICONE PIPE REPAIR
TAPE**



W-R#	Description	Min.	Box
1006002	1 1/2" X 10' Roll	1	24

- Adhesive backed tape bonds to itself, forming an airtight & waterproof seal.
- Temperature range: -65°F to 500°F
- Dielectric--insulates 10,000 volts per layer
- Stops pressurized leaks up to 100 psi
- Resists UV, Oil, & other chemicals
- Made in USA



SPECIALTY CHEMICALS



PERMATEX® PIPE JOINT COMPOUND

W-R#	Description	Min.	Box
1011016	51D 1 pt.	12	12

- Seals pipes to 5000 psi.
- Prevents galling and corrosion.
- Outperforms Teflon tape. Won't shred.
- Non hardening.



PERMATEX® THREAD SEALANT WITH TEFLON

W-R#	Description	Min.	Box
1011039	14D 1 pt.	12	12

- Seals pipes to 5000 psi.
- Prevents galling and corrosion.
- Outperforms Teflon tape. Won't shred.
- Non hardening for easy disassembly



PERMATEX® FORM-A-GASKET NO. 2

W-R#	Description	Min.	Box
1011010	2B 3 oz. tube	12	12

- Improves gasket seal on non rigid, vibrating assemblies
- Slow Drying, flexible setting.
- Withstands pressures to 5,000 lbs.



PERMATEX® CLEAR SILICONE RUBBER ADHESIVE/ SEALANT

W-R#	Description	Min.	Box
1011034	66B 3 oz. tube	12	12

- For gasketing, sealing, bonding, and caulking
- Remains flexible
- Works to 500°



X-PANDO® PIPE JOINT COMPOUND

W-R#	Description	Min.	Box
1024002	14oz.	1	12

- For flanged or threaded joints - the compound that expands as it sets! (from .002" to .004" per cubic inch)
- Certified by Underwriters Laboratory Inc.® to NSF/ANSI 61 for drinking water. Also certified to NSF/ANSI 372 (formerly known as Annex G) as to lead content.

SPECIALTY CHEMICALS



**LEAK-LOCK® PIPE
THREAD SEALANT**

W-R#	Description	Min.	Box
<i>Original Blue Leak-Lock</i>			
1014002	1.3 oz Tube	12	12
1014004	4 oz. Bottle	12	12
1014006	16 oz. Bottle	12	12



**FILL-N-SEAL®
EXPANDING FOAM
SEALANT**

W-R#	Description	Min.	Box
1026002	12 Fl oz.	1	12

- Expands three times its original volume
- Adheres to all building materials except PTFE, silicone and polyethylene



**GREAT STUFF®
“FIREBLOCK”
EXPANDING FOAM
SEALANT**



W-R#	Description	Min.	Box
1026050	12 Fl oz.	1	12

- Orange foam impedes spread of fire and smoke through service penetrations
- Tested according to ASTM E84, ASTM E814 (modified), UL 1715



**NOKORODE®
REGULAR SOLDER
PASTE FLUX**

W-R#	Description	Min.	Box
1008002	2 oz.	1dz	
1008004	1 lb.	1	12

NOKORODE will not freeze or decompose. Recommended for use on all solder alloys including 95/5 and all lead free solders.



RECTORSEAL NO. 5®

W-R#	Description	Min.	Box
1012702	1/4 Pt.	1	12
1012704	1 Pt	1	12

Soft-set, slow drying compound which seals, lubricates, and protects threaded pipe and fittings.



**UTILITY® SOLDER
PASTE FLUX**



W-R#	Description	Min.	Box
1008510	1/2 lb.	1	12
1008504	1 lb.	1	12

UTILITY Paste Flux is the original self-cleaning, lead-free flux. Recommended for all soft solder work, including 95/5.

SPECIALTY CHEMICALS

metacaulk.
Firestopping Products



**RECTORSEAL®
METACAULK 1000
RED FIRESTOP CAULK**

W-R#	Description	Min.	Box
1020002	10.3 oz	1	24

- Metacaulk 1000® is a water-based fire-rated intumescent sealant used to fill the through penetrations of walls and floors. Conforms to ASTM E814, UL1479 & UL 2079 Fire Test Standards.



**GEL-GLOSS®
FIBERGLASS & MARBLE
CLEANER**

W-R#	Description	Min.	Box
1651002	12oz Aerosol	1	12
1651004	16oz Liquid	1	12

- The world's Number 1 selling cleaner and polish for cultured marble and fiberglass! Recommended by major marble, fiberglass, and acrylic manufacturers.



**LIQUID WRENCH®
SUPER PENETRANT**

W-R#	Description	Min.	Box
1016004	11oz. Spray	1	12

- A powerful blend of quick-acting, fast-penetrating solvents that loosens rusted nuts, bolts, and parts in seconds.



**WD-40®
SPRAY LUBRICANT**

W-R#	Description	Min	Ctn
1021002	8 oz	1	12
1021004	11 oz	1	12



**Spray
Nine**

**SPRAY-NINE®
GREZ-OFF
DEGREASER**



W-R#	Description	Min	Ctn
1827002	32 oz	1	12
1827004	1 Gallon	1	4

- Professional strength, biodegradable formula hits hard and fast with powerful water-soluble solvents.
- USDA approved and VOC compliant in all 50 states

SPECIALTY CHEMICALS



**BLACK SWAN® WHITE
TUB & TILE CAULK**

W-R#	Description	Box
1009002	6 oz Hang tube	24
1009004	10.3 oz Cartridge	12

LATEX CAULK



- A siliconized acrylic latex caulk that permanently seals tubs, showers, tile, sinks, windows, doors, etc.



SILICONE CAULK

W-R#	Description	Box
1009011	3 oz White Silicone	12
1009013	3 oz Clear Silicone	12



- 100% silicone caulk
- Adheres to clean metal, glass, most types of wood, silicone resin, vulcanized silicone rubber, ceramic, natural and synthetic fiber, painted surfaces and many plastics.



**GE SEALANTS®
100% SILICONE
KITCHEN & BATH
CAULK**

W-R#	Description	Box
1009020	9.8 oz Clear Silicone	12
1009022	9.8 oz White Silicone	12



- 100% silicone
- 100% waterproof
- 7-year mold-free product protection†
- Meets ASTM C-920, Class 35



**BLACK SWAN®
STAY-SOFT PUTTY**

W-R#	Description	Min.	Box
1018002	14 oz	1	24
1018004	14oz for Marble	1	24

- Non-bleeding, plastic and elastic putty made especially for plumbers. It's not sticky and handles like modeling clay. It keeps indefinitely, and it won't shrink, crack or crumble.



**J-B WELD®
KWIKWELD
STEEL-REINFORCED
EPOXY RESIN**

W-R#	Description	Min.	Box
1007502	10 oz KwikWeld	1	12



- KwikWeld™ has a 1:1 mixing ratio, sets in 6 minutes and is fully cured in 4-6 hours.
- KwikWeld™ cures to a dark grey color, is rated at a tensile strength of 3127 PSI and will withstand temperatures up to 300°F



SPECIALTY CHEMICALS



**SILVER KING®
“SQUICK”
BOILER CLEANER**

W-R#	Description	Min.	Box
1025002	5 oz.	1	12

- Removes rust, oil and scale, stops steam boiler surge instantly. Removes free oxygen, inhibits corrosion. Non hazardous. Contains no petroleum. Gives fast pure dry steam.

- Use 1 pc. 5oz can for each 150,000 BTU's



**SILVER KING®
BOILER SOLDER**

W-R#	Description	Min.	Box
1025008	16 oz.	1	12

- Stops leaks in steam and hot water boilers. Forms a water insoluble seal in old and new installations. Contains no petroleum. Stopping leaks in boilers & hot water systems for over 60 years.

- Do not use in boilers with submerged coils - use SAFE Liquid Boiler Stop Leak



**SILVER KING®
NUMBER 5
HYDRONIC CLEANER**

W-R#	Description	Min.	Box
1025004	1 qt.	1	12

- Inhibits corrosion, removes sludge, frees stuck zone valves, protects and lubricates entire system. Prevents clogging of automatic valves. Safe to use in all boilers. Quiets noisy boilers and circulators. Contains no petroleum. Non-hazardous.

- Use 1 qt. for each 30 gallons of system water



**SILVER KING®
SAFE STOP-LEAK**

W-R#	Description	Min.	Box
1025006	1 qt.	1	12

- Quietly stops leaks in all steel and cast iron boilers. For both steam boilers and entire hot water systems, including baseboards, copper lines and radiant heat systems. Safe to use in all boilers - contains no petroleum - will not surge - will not sludge submerged coils.

- Steam Boilers - Use 1 qt. for each 650' of radiation.

- Hot Water Systems - Use 1 qt. for each 400' of radiation.

SPECIALTY CHEMICALS

WHITE TEFLON TAPE



W-R#	Description	Min.	Box
1001002	1/2" x 260"	1	100
1001004	1/2" x 520"	1	100
1001008	3/4" x 520"	1	100

- 3.5 mil thick (Density .4)

YELLOW TEFLON TAPE



W-R#	Description	Min.	Box
1001010	1/2" x 260"	1	100
1001020	1/2" x 520"	1	100
1001022	3/4" x 520"	1	100

- 4 mil thick (Density .9)
 - Can be used for Gas applications



**PORC-A-FIX®
TOUCH-UP PAINT**

W-R#	Description	Min.	Box
------	-------------	------	-----

for American Standard

1010101	White	AS-1	1	4
1010107	Bone	AS-07	1	4
1010111	Fawn Beige	AS-11	1	4
1010133	Sterling Silver	AS-33	1	4
1010169	Linen	AS-69	1	4

for Eljer

1010301	White	EM-01	1	4
---------	-------	-------	---	---

for Gerber

1010402	White	GB-1	1	4
1010414	Almond	GB-14	1	4

for Kohler

1010501	White	KK-01	1	4
1010514	Black	KK-14	1	4
1010528	Almond	KK-28	1	4
1010546	Biscuit	KK-46	1	4



**WHITE PORCELAIN
GLAZE**



W-R#	Description	Min.	Box
1010002	1 oz.	12	12

- White, high-temperature touch-up paint for appliances
 - Rated for up to 400°F

SPECIALTY CHEMICALS

PAINT CRAYONS



W-R#	Description	Min	Box
1812500	Yellow	DZ	DZ
1812501	Red	DZ	DZ
1812503	Black	DZ	DZ

- Sold by the dozen only, no broken dozens

8 OZ. CIRCULATOR LUBRICATING OIL



W-R#	Description	Min.	Box
1019002	8 OZ.	1	12

A special blend of non-detergent oils for lubricating oil burners, electric motors, pumps, circulators, etc.

SPECTRACIDE® WASP & HORNET SPRAY



W-R#	Description	Min	Box
1037002	20 oz Spray	1	12

- Up to 27 foot jet spray
- Kills on contact
- Non-staining

CATCHMASTER® DISPOSABLE PEST GLUEBOARDS



W-R#	Description	Min	Box
1037050	Mouse/Insect	12	96
1037052	Rat	10	30



- Folding glue boards

PERMATEX® FAST ORANGE® HAND CLEANER



W-R#	Description	Min	Box
1011102	15 oz	1	12
1011106	1 gallon	1	2



- The #1 selling, biodegradable, waterless, petroleum solvent-free hand cleaner that contains no harsh chemicals, petroleum solvents or ammonia that can sting cuts or abrasions.

BUILDING MATERIALS

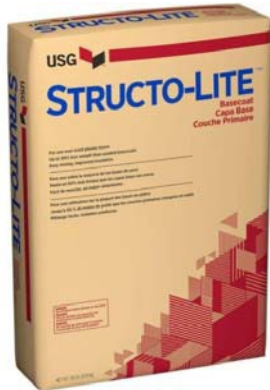

**USG®
STRUCTOLITE®
BASECOAT PLASTER**

W-R#	Description	Min	Pallet
------	-------------	-----	--------

1903004	50 Lb Bag	12	40
----------------	-----------	----	----

- Structo-Lite® Basecoat Plaster is mill-mixed, perlite-aggregate gypsum that weighs half as much as sanded basecoat plaster and provides thermal conductivity.
- Additional shipping & handling charges apply.



**USG®
ALL-PURPOSE
JOINT COMPOUND**

W-R#	Description	Min	Pallet
------	-------------	-----	--------

1012020	5 Gallon	6	40
----------------	----------	---	----

1012022	1 Gallon	6	-
----------------	----------	---	---

- Recommended for laminating and repairing cracks in interior plaster and masonry not subject to moisture.
- Additional shipping & handling charges apply.



**QUIKRETE®
CEMENT & CONCRETE
PRODUCTS**

W-R#	Description	Min	Pallet
------	-------------	-----	--------

1903010	60 lb. Sand/Topping	12	40
----------------	---------------------	----	----

1903014	40 lb. Concrete	12	40
----------------	-----------------	----	----

1903018	40 lb. Mortar	12	40
----------------	---------------	----	----

- Quikrete is the number 1 manufacturer of cement & concrete products in the USA.
- Additional shipping & handling charges apply.



**DAP®
PLASTER OF PARIS**

W-R#	Description	Min	Box
------	-------------	-----	-----

1831002	4 lb. Can	1	6
----------------	-----------	---	---

- Plaster of Paris is for general wall and ceiling repairs. Sets fast in 20-30 minutes without shrinking.



**DAP®
SPACKLING PASTE**

W-R#	Description	Min	Box
------	-------------	-----	-----

1831010	8 oz. Can	1	12
----------------	-----------	---	----

- Fills and conceals small cracks, nail holes and blemishes in plaster, wallboard and wood



BUILDING MATERIALS



**POR-ROK®
AQUA-PLUG®
HYDRAULIC CEMENT**



W-R#	Description	Min	Box
1012006	5 Lb.	1	8
1012008	10 Lb.	1	4

- POR-ROK® AQUA PLUG is quick sets in 3-5 minutes to stop pressure leaks in concrete and masonry surfaces.



**PACKAGE PAVEMENT®
ALL-WEATHER
BLACKTOP PATCH**



W-R#	Description	Min	Pallet
1903030	60 lb. Blacktop Patch	12	40

- Consists of sand, 1/4" aggregate and VOC compliant asphalt. Ready to use and requires no mixing and no heating.
- Additional shipping & handling charges apply.



**MARKING SPRAY PAINT
(UPSIDE-DOWN PAINT)**

W-R#	Description	Min	Box
1031002	Orange	1	12
1031004	Pink	1	12
1031006	Yellow	1	12
1031008	White	1	12
1031010	Red	1	12
1031012	Blue	1	12
1031014	Green	1	12



MARKING PAINT WAND

W-R#	Description	Min	Box
1032002	Short Wand	1	2
1032010	Long Wand	1	1



**KRYLON®
FUSION® ALL-IN-ONE
SPRAY PAINT**



W-R#	Description	Min	Box
1035002	Hi-Heat Black	1	12
1035004	Flat Black	1	12
1035006	Gloss Black	1	12
1035008	Flat White	1	12
1035010	Battleship Gray	1	12
1035012	Metallic Silver	1	12

- Indoor/outdoor use with maximum rust protection
- No sanding or priming required

Table of Pipe Outside Diameters

	1/2"	3/4"	1"	1 1/4"	1 1/2"	2"	3"	4"	5"	6"	8"	10"	12"
Steel	.84	1.05	1.32	1.66	1.90	2.38	3.50	4.50	5.56	6.63	8.63	10.75	12.75
Copper	.63	.88	1.13	1.38	1.63	2.13	3.13	4.13	5.13	6.13	-	-	-
PVC	.84	1.05	1.32	1.66	1.90	2.38	3.50	4.50	5.56	6.63	8.63	10.75	12.75
DIP A	-	-	-	-	-	2.50	3.80	4.80	-	6.90	9.05	11.10	13.20
DIP B	-	-	-	-	-	-	3.96	5.00	-	7.10	9.05	11.10	13.20
DIP C/D	-	-	-	-	-	-	3.96	5.00	-	7.10	9.30	11.40	13.50
CIP	-	-	-	-	-	2.30	3.30	4.30	5.30	6.30	8.40	10.50	12.50
AA Lead	(5/8)1.10	1.23	1.51	1.78	2.09	2.77	-	-	-	-	-	-	-

Conversion Data:

- Foot 0.3048 meters
- Gallon 3.78 liters
- Inch 0.0278 yards
- Inch 0.083 feet
- Inch 25.40 millimeters
- Kilogram 2.20 pounds
- Liter 0.264 gallons
- Meter 3.28 feet
- Millimeter 0.039 inches
- Ounce 0.0625 pounds
- Pound 16 ounces
- PSI 2.31 feet of water
- PSI 6.89 kPA

- Circumference: π diameter
- Diameter: Circumference/ π
- π : 3.14



PLEASE COMPLETE THIS CREDIT APPLICATION TO ESTABLISH AN ACCOUNT WITH WAL-RICH CORPORATION. YOUR ASSISTANCE IN PROVIDING US WITH COMPLETE INFORMATION WILL ENSURE THAT YOUR ORDER IS SHIPPED PROMPTLY.
THE WAL-RICH TEAM THANKS YOU FOR YOUR ORDER!

YOUR COMPANY INFORMATION

COMPANY NAME: _____

SHIPPING ADDRESS: _____

BILLING ADDRESS: _____

CITY: _____ STATE: _____ ZIP: _____

PHONE: _____ FAX: _____

PURCHASING CONTACT: _____ A/P CONTACT: _____

EMAIL ADDRESS: _____

STATE RESALE # _____

TRADE REFERENCES

COMPANY NAME: _____ ADDRESS: _____ CITY: _____ STATE: _____ ZIP: _____ PHONE: _____ FAX: _____	COMPANY NAME: _____ ADDRESS: _____ CITY: _____ STATE: _____ ZIP: _____ PHONE: _____ FAX: _____
COMPANY NAME: _____ ADDRESS: _____ CITY: _____ STATE: _____ ZIP: _____ PHONE: _____ FAX: _____	COMPANY NAME: _____ ADDRESS: _____ CITY: _____ STATE: _____ ZIP: _____ PHONE: _____ FAX: _____

BANK REFERENCE

BANK NAME: _____

ADDRESS: _____

CITY: _____ STATE: _____ ZIP: _____

PHONE: _____ FAX: _____

SHIPPING INSTRUCTIONS

PENDING CREDIT APPROVAL, SHIP THIS ORDER ASAP VIA CREDIT CARD

INSTRUCTIONS: _____

We certify that all the information on this form is correct, and fully understand Wal-Rich's credit terms. We agree to proper payment in consideration of extended credit.

Authorized Signature (required) _____ Title _____

Print Name _____ Date _____

NUMERICAL INDEX

0101002	138	0209014	91	0402102	59	0417606	20	0509500	130
0101004	138	0209016	91	0403002	68	0417702	19	0509500	140
0101008	138	0209020	91	0406010	54	0417704	19	0511002	129
0101012	138	0210002	91	0406012	54	0417706	19	0512002	129
0101016	138	0210006	91	0407002	55	0417708	19	0512500	132
0101048	138	0215006	91	0407004	55	0417710	19	0512508	132
0102008	138	0215008	91	0407052	55	0418000	115	0513002	129
0102016	138	0219002	155	0407054	55	0418002	19	0515002	128
0104004	138	0224002	83	0408002	46	0418004	19	0515004	128
0104006	138	0224002	92	0408004	46	0418006	19	0515006	128
0104010	138	0226020	62	0408006	46	0418802	20	0515008	128
0104012	138	0302502	87	0408102	46	0418804	20	0517002	129
0104030	138	0302504	87	0408104	46	0419002	19	0518500	129
0104034	138	0302506	87	0408302	55	0419004	19	0519002	129
0106002	139	0302508	87	0408304	55	0419006	118	0520002	146
0107016	139	0302510	87	0409002	46	0419008	118	0520004	146
0107040	139	0302512	87	0409004	46	0420002	118	0520006	146
0108016	139	0302514	87	0409502	46	0420004	118	0521002	134
0108018	139	0302516	87	0409504	46	0421000	118	0521004	134
0108020	139	0302518	87	0414204	121	0421002	118	0521020	134
0108024	139	0302520	87	0414206	121	0421004	118	0522002	134
0108032	139	0302522	87	0414208	121	0421004	251	0522004	134
0109008	139	0302524	87	0414210	121	0422010	13	0522006	134
0109016	139	0302526	87	0414302	121	0422302	145	0522008	134
0109030	139	0302534	87	0414304	121	0422304	145	0523000	135
0109034	139	0302544	87	0414502	133	0422306	145	0523002	135
0109042	139	0302546	87	0414606	121	0422308	145	0523004	134
0109044	139	0302548	87	0414706	121	0423002	19	0523005	134
0109054	139	0302550	87	0414806	121			0523006	135
0110004	140	0302552	87	0414812	121	0423702	19	0523007	135
0112024	141	0302554	87	0414906	121	0424112	21	0523010	136
0112026	141	0302556	87	0414906	146	0424116	21	0523012	135
0112030	141	0302558	87	0415402	19	0424120	21	0523014	135
0113002	141	0302560	87	0415404	19	0425001	21	0523014	135
0113004	141	0302562	87	0415406	19	0425002	21	0523016	135
0113006	141	0302564	87	0416002	21	0425004	21	0523022	136
0115002	140	0341002	87	0416004	21	0431006	126	0523024	136
0115004	140	0341004	87	0416006	21	0431008	126	0523030	135
0115006	140	0341102	87	0416008	21	0501006	132	0523031	135
0115008	140	0341104	87	0416010	21	0502006	132	0523032	136
0116002	141	0341402	87	0416602	20	0503000	132	0523040	135
0117022	140	0341404	87	0416604	20	0503002	132	0523050	135
0117024	140	0341502	88	0416606	20	0504002	130	0523052	135
0117026	140	0341504	88	0416802	20	0504004	130	0523102	135
0117050	140	0341602	88	0416804	20	0504006	130	0523104	135
0117202	132	0341606	88	0416806	20	0504008	130	0524010	150
0117204	132	0341608	88	0416902	20	0504102	130	0524012	150
0207006	91	0341904	88	0416904	20	0505002	130	0524020	150
0207008	91	0349014	88	0416906	20	0505003	130	0524022	150
0207010	91	0400120	122	0417402	121	0505004	130	0525004	133
0208002	91	0400122	122	0417404	121	0506002	130	0525006	133
0208006	91	0402002	59	0417406	121	0506500	130	0525012	133
0209008	91	0402008	59	0417602	20	0508002	129	0526002	133
0209012	91	0402010	59	0417604	20	0509002	129	0526004	133

NUMERICAL INDEX

0527004	133	0607102	167	0622002	216	0807020	113	0817502	57
0527500	164	0608007	158	0623000	134	0808002	113	0817504	57
0527600	113	0608010	157	0623502	166	0808006	113	0817506	57
0528002	132	0608014	157	0623504	166	0808008	113	0817508	57
0528004	132	0608016	157	0623506	166	0809000	114	0818002	112
0528006	132	0608018	157	0623508	166	0809001	114	0819500	114
0528008	132	0608020	157	0623550	167	0809002	114	0819501	114
0529502	132	0608021	157	0623552	167	0809004	114	0819502	114
0529504	132	0608026	158	0623554	167	0809006	114	0819504	114
0529506	132	0608028	157	0623602	117	0809008	114	0819504	114
0530002	134	0608030	157	0623602	117	0809010	114	0819506	114
0531000	162	0608031	157	0624502	117	0809012	114	0819508	114
0531002	162	0608032	158	0624502	117	0809014	114	0819510	114
0531052	162	0608114	157	0625002	155	0809020	114	0819512	114
0532002	133	0608214	157	0626002	162	0809022	114	0819520	114
0533002	117	0609002	158	0626006	162	0809024	114	0819524	114
0541002	136	0610002	158	0626012	162	0809026	114	0819528	114
0541004	136	0611002	158	0626025	163	0809028	114	0819532	114
0541006	136	0614002	156	0626030	163	0810002	122	0819536	114
0590002	126	0614004	156	0626056	162	0810004	122	0901002	143
0590004	126	0614005	155	0627002	163	0810010	122	0901004	143
0601002	160	0614008	156	0627004	163	0811005	123	0901006	143
0601006	160	0614009	156	0627006	163	0811012	124	0901008	143
0601008	160	0614010	154	0705002	155	0811020	123	0901010	143
0601012	160	0614011	156	0708010	101	0811022	123	0902002	143
0602002	160	0614014	155	0713002	102	0811102	123	0902004	143
0602004	160	0614050	156	0713004	102	0811104	123	0902006	143
0602006	160	0614055	156	0713006	102	0811108	123	0902008	143
0602021	160	0614057	156	0713008	102	0812001	124	0902010	143
0602022	160	0614059	156	0713010	102	0812003	124	0902012	143
0602024	160	0615002	155	0713014	102	0812005	124	0903002	143
0602505	160	0615004	155	0713020	102	0812007	124	0903004	143
0602506	160	0618002	159	0713030	102	0812008	124	0903006	143
0602705	160	0618004	159	0802002	112	0812010	123	0903007	143
0602706	160	0618006	159	0802004	112	0812020	123	0903008	143
0603002	161	0618008	159	0802006	112	0812024	124	0903010	143
0603004	161	0618010	159	0802008	112	0812026	124	0904002	143
0603006	161	0618012	159	0802010	112	0812028	123	0904004	143
0603008	161	0618020	159	0802012	112	0812030	123	0904006	143
0604002	161	0618022	159	0802302	112	0812040	124	0904008	143
0604004	161	0618030	159	0802304	112	0813004	122	0904010	143
0604006	161	0618040	159	0802306	112	0813008	122	0905002	143
0604008	161	0619002	159	0802504	112	0813012	122	0905004	143
0604010	161	0619004	159	0802505	112	0813014	122	0906002	92
0604012	154	0620001	154	0802506	112	0813016	122	0906004	92
0604502	161	0620002	154	0802508	112	0814042	123	0906006	92
0604504	161	0620003	154	0802512	112	0814102	122	0907002	129
0604506	161	0620004	154	0802702	112	0814104	122	0908008	189
0605012	161	0620005	154	0805003	112	0814106	122	0908010	189
0605013	161	0620007	154	0806004	113	0814108	122	0908012	189
0605014	161	0620008	154	0807002	113	0817002	56	0910002	134
0606002	161	0620009	154	0807006	113	0817004	56	0912002	92
0606502	162	0620020	162	0807008	113	0817006	56	0912004	92
0607002	162	0621002	154	0807010	113	0817008	56	0912006	92

NUMERICAL INDEX

0913002	176	1012702	264	1105002	144	1301008	172	1318026	179
0913006	176	1012704	264	1105006	144	1304000	175	1318028	178
0914002	142	1013002	259	1108005	144	1304002	175	1318030	179
1001002	268	1013012	152	1108006	144	1304010	173	1318032	179
1001004	268	1014002	264	1108202	144	1304012	173	1318034	179
1001006	268	1014004	264	1109002	144	1304016	173	1318038	179
1001008	268	1014006	264	1109004	144	1304018	173	1318042	178
1001010	268	1016004	265	1109006	144	1304020	173	1318050	178
1001020	268	1018002	266	1109008	144	1304040	173	1318052	178
1001022	268	1018004	266	1109506	143	1304042	173	1318060	179
1003002	37	1019002	269	1109508	143	1304044	173	1318070	180
1003004	37	1019502	257	1110010	144	1304200	215	1318072	180
1004002	37	1020002	265	1110012	145	1304202	215	1318090	180
1004020	37	1021002	265	1114006	145	1304300	207	1318090	201
1004030	37	1021004	265	1114014	145	1304302	207	1318092	180
1004102	238	1024002	263	1116004	145	1304506	176	1318092	201
1004104	238	1025002	267	1116006	145	1304508	176	1318094	180
1004106	238	1025004	267	1201004	137	1304514	210	1318094	201
1005810	264	1025006	267	1203002	138	1304524	175	1318096	201
1006002	262	1025008	267	1203010	138	1304525	175	1318144	178
1007002	261	1026002	264	1205006	137	1304532	176	1319002	172
1007502	266	1026050	264	1205008	137	1304536	176	1320002	172
1008002	264	1029002	261	1205012	137	1304604	211	1320004	172
1008004	264	1029004	261	1205013	137	1304610	211	1320006	172
1008504	264	1029006	261	1206008	137	1304702	211	1321006	176
1009002	266	1031002	271	1207002	145	1304705	211	1322006	176
1009004	266	1031004	271	1207004	145	1304712	211	1323002	172
1009011	266	1031006	271	1207052	145	1305004	187	1323010	172
1009013	266	1031008	271	1207090	145	1305006	187	1329500	169
1009020	266	1031010	271	1210010	138	1305008	187	1330000	169
1009022	266	1031012	271	1212000	137	1305500	175	1330004	172
1010002	268	1031014	271	1212002	137	1309002	189	1330006	172
1010101	268	1032002	271	1212004	137	1309004	189	1330008	172
1010107	268	1032010	271	1212006	137	1309006	189	1330500	168
1010111	268	1033002	261	1212008	137	1309008	189	1330502	168
1010133	268	1033004	261	1212010	137	1309010	189	1330503	168
1010169	268	1033010	261	1212004	137	1309012	189	1330506	168
1010301	268	1033012	261	1214004	137	1309014	189	1330508	168
1010402	268	1034002	261	1214006	137	1309016	189	1330510	168
1010414	268	1035002	271	1217006	137	1309016	189	1330512	168
1010501	268	1035004	271	1218002	138	1317002	178	1330516	168
1010514	268	1035006	271	1218002	151	1317004	178	1330518	168
1010528	268	1035008	271	1218004	138	1317010	178	1330518	168
1010546	268	1035012	271	1218004	151	1317074	180	1330520	168
1011010	263	1035014	271	1218006	138	1318000	178	1330522	168
1011016	263	1036002	257	1218006	151	1318001	178	1330530	168
1011034	263	1037002	269	1218008	138	1318002	178	1330532	168
1011039	263	1037050	269	1218008	151	1318004	178	1330534	168
1011102	269	1037052	269	1218010	138	1318006	178	1330536	168
1011106	269	1101002	143	1218010	151	1318008	179	1330538	168
1012006	271	1101003	143	1218012	138	1318015	178	1330552	168
1012008	271	1101004	143	1218012	151	1318018	178	1330560	168
1012020	270	1104002	143	1218014	138	1318019	178	1330604	169
1012022	270	1104004	143	1218014	151	1318022	180	1331002	170
				1301004	172	1318023	180	1331004	170

NUMERICAL INDEX

1331006	172	1346112	182	1358002	186	1371006	165	1512004	140
1331008	172	1346400	185	1358030	186	1371008	165	1602002	102
1331010	169	1346404	185	1358202	186	1371010	165	1602004	102
1331011	170	1346504	185	1358230	186	1371012	165	1602006	102
1331012	171	1348002	188	1358500	186	1401002	164	1602010	102
1331014	169	1348003	188	1358602	186	1401006	164	1610000	68
1331016	169	1349002	182	1358604	186	1402002	166	1610002	96
1331018	169	1349101	183	1359000	181	1402100	166	1610004	96
1331020	179	1349102	183	1359002	181	1404502	165	1610006	96
1331030	169	1349104	183	1359004	181	1405002	132	1610008	96
1331035	171	1349106	183	1359006	181	1405003	132	1610010	96
1331050	170	1349108	183	1359007	181	1405104	133	1610012	96
1331052	170	1349302	183	1359009	181	1405602	165	1610014	96
1331054	170	1349304	183	1359010	181	1405604	165	161006	164
1331056	170	1349315	183	1359012	181	1405606	165	1611004	96
1331060	170	1349500	184	1359014	181	1406002	132	1611006	96
1331062	170	1349502	184	1359500	181	1406004	132	1611008	96
1331062	171	1349504	184	1359502	181	1407002	163	1611009	96
1331070	171	1349506	184	1359504	181	1407004	163	1611010	96
1331072	171	1349603	183	1359508	181	1407006	163	1611012	96
1331074	171	1349604	183	1359510	181	1407008	163	1612002	97
1332002	175	1349606	183	1359514	181	1407010	163	1612004	97
1333002	78	1349702	183	1359522	181	1407014	163	1613006	97
1333004	78	1350002	182	1359524	181	1407016	163	1613009	97
1333006	78	1350004	188	1359526	181	1407018	163	1613010	97
1334004	80	1351002	182	1360004	176	1407020	163	1614002	97
1334006	80	1352002	182	1360008	177	1407022	163	1614004	97
1334008	80	1353002	182	1360009	177	1407602	166	1614006	97
1334010	80	1353004	184	1360020	177	1407604	166	1614008	97
1334012	80	1353006	184	1360100	174	1407608	166	1615020	96
1334014	80	1353008	184	1360102	174	1407610	166	1615022	96
1334050	80	1353010	184	1360104	177	1407612	166	1616004	164
1336015	185	1353014	184	1360106	177	1407620	166	1617002	164
1336016	185	1353018	189	1360202	176	1501002	141	1617004	164
1336019	185	1353020	189	1360204	176	1501004	141	1619004	107
1338000	185	1353022	189	1360302	176	1502002	141	1621002	216
1338006	185	1353024	189	1360304	176	1502004	141	1632002	216
1338008	185	1353030	189	1360402	176	1502008	141	1633002	216
1343012	185	1353032	189	1360502	176	1504004	141	1633302	216
1343016	185	1353600	186	1360504	176	1504008	141	1634002	216
1343030	185	1353602	188	1361002	173	1506002	141	1641002	99
1343042	185	1353604	188	1362004	173	1506004	141	1641004	99
1344006	185	1354002	186	1362006	173	1508002	142	1641006	99
1344008	185	1354200	188	1363002	188	1509002	142	1642002	99
1344010	185	1354300	186	1363004	188	1510000	142	1642004	99
1344012	185	1354500	187	1365002	188	1510002	142	1642502	99
1344014	185	1354602	187	1370002	165	1510004	142	1645500	107
134402	185	1354604	187	1370004	165	1510006	142	1645504	107
1344020	185	1354700	186	1370006	165	1510008	142	1645506	107
1346081	182	1354900	187	1370008	165	1510009	142	1646002	92
1346083	182	1355002	189	1370010	165	1510010	142	1646004	92
1346090	182	1356002	186	1370012	165	1511002	140	1646010	92
1346092	182	1356004	186	1371002	165	1511004	140	1647002	102
1346110	182	1357002	186	1371004	165	1512002	140	1648002	102

NUMERICAL INDEX

1650000	262	1675002	208	1708010	49	1715502	41	1726020	45
1650001	262	1675500	208	1709002	49	1717002	39	1726022	45
1650002	102	1676002	208	1709004	49	1717004	39	1727000	51
1651002	265	1676500	208	1711009	44	1718002	68	1727001	51
1652006	108	1677002	113	1711010	45	1718004	68	1727002	51
1652008	108	1678020	164	1711011	44	1719002	40	1727004	51
1652009	108	1678022	164	1711012	45	1719004	40	1727006	51
1652010	108	1678030	164	1711015	44	1719006	40	1727008	51
1652012	108	1679004	103	1711016	44	1720000	40	1727010	51
1652014	108	1679006	103	1711018	44	1720002	40	1727012	51
1652020	108	1679008	103	1711019	44	1720004	40	1727606	51
1652020	216	1679012	103	1712002	39	1720006	40	1727608	51
1652030	108	1680002	164	1712004	39	1721002	40	1727610	51
1654000	107	1683002	221	1712006	39	1721010	40	1728000	98
1654001	107	1683004	221	1712008	39	1722000	43	1728002	98
1654002	167	1683006	221	1712010	39	1722001	43	1728004	98
1654005	107	1684002	221	1712012	39	1722002	43	1728006	98
1655000	107	1684004	221	1712014	39	1722004	43	1728008	98
1656000	107	1684006	221	1712016	39	1722006	43	1728010	98
1656001	107	1684008	221	1712502	39	1722008	43	1728012	98
1656005	107	1691002	162	1712504	39	1722011	43	1729000	98
1656007	107	1700102	47	1712506	39	1722013	43	1729002	98
1658002	107	1700104	47	1712508	39	1722014	43	1729004	98
1658004	107	1700106	47	1712510	39	1722015	43	1729006	98
1661000	145	1700108	47	1712512	39	1722016	43	1729008	98
1661002	145	1700110	47	1712514	39	1722017	43	1729010	98
1661004	145	1700200	47	1712516	39	1722020	44	1729012	98
1662002	16	1700302	47	1712601	40	1722025	44	1729014	98
1662004	16	1700304	47	1712602	40	1722030	44	1729016	98
1662006	16	1700306	47	1712604	40	1722050	43	1729018	98
1668002	220	1700308	47	1712606	40	1722052	43	1729020	98
1670002	220	1700310	47	1712608	40	1722060	43	1729022	98
1670004	220	1701202	47	1712802	39	1723002	48	1729024	98
1670006	220	1701204	47	1712804	39	1723006	52	1730002	98
1670008	220	1701208	47	1712806	39	1723200	48	1730004	98
1670010	220	1701210	237	1712808	39	1724000	48	1730006	98
1670012	220	1702002	52	1712810	39	1724001	48	1730008	98
1670014	220	1702004	52	1712812	39	1724002	48	1730010	98
1670016	220	1703002	52	1712814	39	1724004	48	1731002	98
1670018	220	1703004	52	1712816	39	1724006	48	1731004	98
1670020	220	1704002	52	1712818	39	1724008	48	1731006	98
1670022	220	1704004	52	1713002	39	1724012	48	1731006	98
1670024	220	1704005	52	1713004	39	1724018	48	1731008	98
1671006	207	1705002	46	1713006	39	1724022	48	1731010	98
1672002	209	1705004	46	1713008	39	1725002	52	1731012	98
1672020	209	1705006	46	1713010	39	1725006	51	1731014	98
1673004	208	1706002	45	1713012	39	1725008	51	1731016	98
1673006	133	1706004	45	1713014	39	1725009	51	1731018	98
1673010	208	1706006	45	1713016	39	1725010	51	1731500	97
1674002	207	1706008	45	1713018	39	1725504	51	1731502	97
1674010	208	1708002	49	1714002	40	1725510	51	1731504	97
1674012	207	1708004	49	1714004	40	1725602	51	1731506	97
1674020	208	1708006	49	1714202	40	1726004	45	1731508	97
1674500	208	1708008	49	1715500	41	1726010	45	1731510	97

NUMERICAL INDEX

1731512	97	1751010	61	1804052	236	1811014	234	1816010	250
1731514	97	1751011	49	1804054	236	1811102	234	1816011	250
1731516	97	1751012	49	1805006	236	1812002	235	1817000	251
1731518	97	1751014	59	1806004	232	1812028	232	1817002	248
1731520	97	1751016	59	1807020	232	1812030	233	1817003	248
1731602	97	1751018	59	1807026	232	1812032	233	1817004	250
1731604	97	1751022	59	1807030	232	1812040	232	1817006	251
1731606	97	1751030	61	1807030	232	1812060	233	1817008	251
1731608	97	1751032	45	1808004	234	1812062	233	1817010	251
1731610	97	1751034	45	1808202	254	1812064	233	1817016	250
1731612	97	1751038	45	1808204	254	1812066	233	1817040	230
1731802	97	1752002	61	1808206	254	1812070	233	1817045	230
1732500	97	1752004	61	1808215	234	1812090	232	1818000	248
1732502	97	1752006	61	1808260	253	1812091	232	1818004	248
1732504	97	1754002	19	1808262	253	1812095	232	1818005	248
1732506	97	1754004	19	1808264	253	1812096	232	1818008	249
1732508	97	1754006	19	1808266	253	1812102	230	1818010	249
1732510	97	1754008	19	1808268	253	1812105	230	1818106	249
1732512	97	1754010	19	1808270	254	1812107	230	1818108	249
1732514	97	1756002	22	1808272	254	1812108	230	1818110	249
1732516	97	1757004	22	1808273	254	1812110	231	1818118	251
1732518	97	1757006	22	1808274	254	1812208	230	1818120	251
1735002	18	1757008	22	1808302	76	1812210	230	1818122	231
1735004	18	1757010	22	1808320	80	1812212	233	1818124	231
1735006	18	1801000	49	1808322	80	1812302	233	1818126	249
1739002	56	1801004	49	1808403	252	1812304	233	1818128	249
1739004	56	1801006	49	1808403	81	1812310	233	1818130	249
1739006	56	1801008	49	1808452	252	1812312	233	1818134	249
1739010	56	1802000	255	1808452	81	1812500	269	1818135	250
1739202	56	1802002	255	1808620	260	1812501	269	1818135	81
1739302	56	1802004	255	1808622	260	1812502	231	1818137	250
1741002	60	1802006	255	1808630	260	1812503	269	1818137	81
1741004	60	1802008	255	1808632	260	1812504	231	1818140	250
1741010	60	1802020	255	1808634	260	1812514	231	1818140	81
1741012	60	1802022	255	1808636	260	1812518	231	1818142	248
1742002	60	1802125	255	1808638	260	1812522	231	1818144	248
1742003	60	1802127	255	1808644	260	1812526	231	1818146	249
1742004	60	1802210	256	1808650	260	1812528	231	1818148	252
1742005	60	1802212	256	1808652	260	1812530	231	1818150	252
1743002	48	1802214	44	1808899	253	1812532	231	1818400	248
1743200	56	1802216	44	1809000	234	1812534	231	1818500	252
1743202	56	1802302	255	1809002	234	1812542	231	1818500	81
1743204	56	1802304	255	1809004	234	1812600	80	1818560	252
1743206	56	1802350	255	1809006	234	1812602	80	1818560	81
1743208	56	1802352	255	1809008	234	1812604	80	1818610	229
1744002	59	1803000	119	1809010	234	1812606	80	1818620	229
1744004	59	1803002	119	1809012	234	1812608	80	1818624	229
1747002	150	1803006	119	1809014	234	1812800	231	1818632	229
1751002	24	1803008	119	1811002	234	1813002	235	1819002	255
1751002	61	1803502	120	1811004	234	1814002	235	1819004	255
1751004	24	1803504	120	1811006	234	1814006	235	1819006	255
1751004	61	1804006	236	1811008	234	1814008	235	1819008	255
1751006	24	1804048	236	1811010	234	1815002	252	1819010	255
1751006	61	1804050	236	1811012	234	1816002	250	1820002	229

NUMERICAL INDEX

1820004	229	1836202	150	1838150	41	1842202	66	1851050	199
1820006	229	1836204	150	1838200	41	1842204	66	1853006	259
1820008	229	1837001	64	1838502	151	1842206	66	1858400	252
1820010	229	1837002	151	1838504	151	1842208	66	1861000	243
1820012	229	1837004	151	1839002	239	1842302	65	1861004	243
1820014	229	1837006	151	1839008	239	1842304	65	1861006	243
1820016	229	1837008	151	1839049	239	1842306	65	1861010	243
1820018	229	1837010	151	1839050	239	1842321	65	1862050	243
1821000	243	1837025	64	1839051	239	1842323	65	1863002	139
1821002	243	1837040	64	1839053	239	1842325	65	1864001	66
1821003	243	1837050	64	1839057	239	1842500	34	1864002	66
1821004	243	1837200	148	1839059	239	1842502	34	1864004	66
1822002	48	1837200	17	1839060	239	1842610	65	1871002	243
1823002	236	1837202	148	1839065	239	1842612	65	1871004	243
1823004	236	1837202	17	1839070	240	1842614	65	1871006	243
1823006	236	1837204	148	1839072	240	1842631	65	1871008	243
1823008	236	1837204	17	1839102	240	1842633	65	1871010	243
1824002	247	1837206	148	1839104	240	1842635	65	1871012	243
1824004	247	1837206	17	1839302	240	1843002	229	1871500	243
1824008	247	1837220	148	1839304	240	1843004	229	1872002	236
1824010	247	1837220	17	1839510	241	1843006	229	1872004	236
1824504	245	1837222	148	1839511	241	1843008	229	1872006	236
1825002	245	1837222	17	1839532	241	1843010	229	1872012	236
1825004	244	1837224	148	1839534	241	1843012	229	1876004	64
1825006	245	1837224	17	1839536	241	1845002	245	1876022	64
1825020	244	1837226	148			1845004	245	1876050	64
1825030	244	1837226	17	1839599	241	1846000	253	1876052	64
1825050	245	1837228	148	1839602	241	1846002	253	1876054	64
1825052	245	1837228	17	1839604	241	1846004	253	1876056	64
1826002	244	1837400	148	1839606	241	1846006	253	1876070	64
1826004	244	1837400	17	1839608	241	1846502	253	1876072	64
1826006	244	1837402	148	1839702	240	1846504	253	1876080	64
1827002	265	1837402	17	1839704	240	1846506	253	1876082	64
1827004	265	1837404	148	1839802	241	1846512	253	1881002	256
1829001	245	1837404	17	1839820	242	1847004	66	1881004	256
1830006	244	1837406	148	1839832	242	1847007	66	1881006	256
1831002	270	1837406	17	1839834	242	1847011	66	1881008	256
1831010	270	1837502	148	1839836	242	1847017	66	1881010	254
1831504	244	1837502	17	1839872	242	1847024	66	1881012	254
1832002	151	1837504	148	1839882	242	1847036	66	1882050	256
1832004	151	1837504	17	1839884	242	1847500	235	1890002	251
1832006	151	1837506	148	1840002	237	1848000	235	1896002	63
1833004	151	1837506	17	1840102	253	1848001	235	1896004	63
1833006	151	1837508	148	1840104	253	1848002	237	1900002	262
1833008	151	1837508	17	1841002	238	1848004	237	1900004	262
1835000	235	1838002	151	1841600	66	1848006	237	1903004	270
1835002	235	1838100	41	1841602	66	1848010	237	1903010	270
1835004	235	1838102	41	1842002	65	1848012	237	1903014	270
1835006	235	1838103	41	1842003	65	1848502	237	1903018	270
1835008	235	1838104	41	1842004	65	1848610	237	1903030	271
1836002	150	1838106	41	1842102	65	1849000	247	1903600	259
1836004	150	1838108	41	1842104	65	1849001	247	1904002	24
1836006	150	1838110	42	1842111	65	1850000	221	1904004	24
1836008	150	1838112	42	1842113	65	1851000	199	1905000	237

NUMERICAL INDEX

1906004	237	1995008	110	2012022	89	2171008	181	2208010	115
1906018	237	1995010	111	2012026	89	2201002	63	2208012	115
1906020	237	1995012	110	2012030	89	2201050	63	2208016	115
1907102	262	1995013	111	2012032	89	2201052	63	2208020	115
1907104	262	1995014	111	2012036	89	2202002	150	2208024	115
1908002	253	1995018	111	2012040	89	2202010	150	2208028	115
1909002	24	1995020	111	2012042	89	2202012	150	2208032	115
1909014	24	1995024	111	2012046	89	2202050	57	2208036	115
1910002	24	1995030	110	2012050	89	2202052	57	2208040	115
1910004	24	1996002	111	2012052	89	2202054	57	2208048	115
1920008	152	2001002	85	2012054	89	2202056	57	2208052	115
1920010	152	2001006	85	2012060	90	2202060	57	2208072	115
1920012	152	2001008	85	2012062	90	2202070	57	2208088	115
1920014	152	2001010	85	2012064	90	2202072	57	2208104	115
1920016	152	2002004	85	2012070	90	2202074	57	2209004	115
1920018	152	2002006	85	2012072	90	2202080	57	2209006	115
1920050	152	2002008	85	2012074	90	2202082	57	2209008	115
1921002	238	2002010	85	2012080	90	2202084	57	2209010	115
1924002	238	2002011	85	2012082	90	2203004	150	2209012	115
1924010	238	2002012	85	2012084	90	2204002	13	2209016	115
1924050	238	2002014	85	2012300	90	2204004	13	2209020	115
1924106	259	2002016	85	2012500	90	2204006	13	2209024	115
1924110	259	2003006	85	2012502	90	2204008	13	2209028	115
1940002	62	2003008	85	2012504	90	2206002	13	2209032	115
1940004	62	2003016	85	2013600	83	2206006	13	2209036	115
1940005	62	2003018	85	2013602	83	2206010	13	2209040	115
1940006	62	2003020	85	2014004	83	2206014	13	2209048	115
1940007	62	2003024	85	2014008	83	2206018	13	2209052	115
1940008	62	2003026	85	2014012	83	2206022	13	2209072	115
1940010	62	2003030	85	2014014	83	2206026	13	2209088	115
1945004	62	2003032	85	2015004	83	2206030	13	2209104	115
1950002	62	2006002	85	2015006	83	2206102	13	2210006	136
1950006	62	2006004	85	2015006	92	2206104	13	2210008	136
1951002	62	2006008	85	2015008	83	2206106	13	2210010	136
1960002	63	2006010	85	2015010	83	2206108	13	2210012	136
1960006	63	2006012	85	2015012	83	2206110	13	2211002	149
1960008	63	2006014	85	2019502	60	2206112	13	2211004	149
1963002	62	2006016	85	2019502	84	2206114	13	2213002	126
1963052	62	2006018	85	2019504	60	2206116	13	2213004	126
1963054	62	2006020	85	2019504	84	2206118	13	2213006	126
1964004	59	2006022	85	2103002	53	2206120	13	2215002	118
1964007	59	2007006	86	2103050	53	2206202	13	2215004	118
1980002	257	2007008	86	2103052	53	2206204	13	2311500	158
1981002	257	2007010	86	2103054	53	2206206	13	2311502	158
1982004	257	2008008	85	2104006	142	2206208	13	2330002	73
1991002	109	2008010	85	2106002	53	2206210	13	2330004	73
1991006	109	2008012	85	2106004	53	2206212	13	2340002	73
1991014	109	2008016	85	2110004	142	2206214	13	2340004	73
1991018	109	2008018	85	2110006	142	2206216	13	2350002	73
1991022	109	2008020	85	2112000	86	2206218	13	2350004	73
1991026	109	2012002	89	2112002	86	2206220	13	2350006	73
1995002	110	2012004	89	2130002	57	2208004	115	2350008	73
1995004	110	2012008	89	2130004	57	2208006	115	2350010	73
1995006	110	2012020	89	2130006	57	2208008	115	2350012	73

NUMERICAL INDEX

2360002	73	2402104	76	2411008	65	2423604	146	2424810	147
2360004	73	2402202	76	2411010	65	2423704	146	2425004	159
2360006	73	2402204	76	2411012	65	2423902	146	2425010	149
2360008	73	2402302	80	2412002	69	2423904	146	2425036	58
2360010	73	2402402	80	2412004	69	2423906	146	2425038	58
2360012	73	2402502	24	2412008	69	2424002	148	2425044	58
2380002	73	2402504	24	2412010	69	2424004	148	2425046	58
2380004	73	2402506	24	2412012	69	2424006	148	2425050	35
2380006	73	2402508	24	2413022	70	2424008	148	2425052	35
2390002	75	2403002	79	2413024	70	2424010	148	2425054	35
2390004	75	2403006	79	2413026	70	2424012	148	2425060	58
2390006	75	2403008	79	2413028	70	2424014	148	2425072	35
2390008	75	2404002	79	2413030	70	2424016	148	2425074	35
2391002	73	2404006	79	2413032	70	2424018	148	2425102	147
2391004	73	2404008	79	2414022	70	2424200	147	2425104	147
2392002	72	2404100	79	2414024	70	2424202	147	2425106	147
2392004	72	2404102	79	2414026	70	2424204	147	2425108	147
2392006	72	2404104	79	2414028	70	2424206	147	2425110	147
2392008	72	2405002	185	2414030	70	2424208	147	2425300	147
2392010	72	2405003	185	2414032	70	2424210	147	2425302	147
2393002	75	2405004	72	2415022	70	2424212	147	2425304	147
2393004	75	2405006	72	2415024	70	2424214	147	2425308	147
2393006	75	2405008	72	2415026	70	2424216	147	2425310	147
2393008	75	2405010	72	2415028	70	2424218	147	2425502	58
2393010	75	2405012	72	2415030	70	2424300	147	2425504	58
2393012	75	2405014	72	2415032	70	2424302	147	2425506	58
2393014	75	2405016	72	2416004	74	2424304	147	2425511	58
2393016	75	2405018	72	2417404	74	2424306	147	2425513	58
2393018	75	2405020	72	2418004	74	2424308	147	2425515	58
2393020	75	2406000	74	2419002	72	2424310	147	2425520	58
2394002	75	2406001	74	2419004	72	2424312	147	2425522	58
2394004	75	2406002	74	2419006	72	2424314	147	2425524	58
2394006	75	2406007	74	2419502	72	2424316	147	2425531	58
2394008	75	2406009	74	2419504	72	2424404	149	2425533	58
2394010	75	2407402	74	2419506	72	2424406	149	2425535	58
2394012	75	2408002	74	2419602	72	2424408	149	2425540	58
2395002	75	2409002	74	2419604	72	2424410	149	2425542	58
2395004	75	2409006	79	2419606	72	2424502	149	2425544	58
2395006	75	2409102	74	2421002	103	2424602	149	2425561	58
2395008	75	2409104	74	2422002	72	2424604	149	2425563	58
2395010	75	2409106	74	2422004	72	2424606	149	2425565	58
2395012	75	2410000	69	2422005	72	2424622	149	2425570	58
2401002	79	2410002	69	2422006	72	2424624	149	2425572	58
2401202	66	2410006	69	2422008	72	2424626	149	2425574	58
2401204	66	2410008	69	2422010	72	2424650	149	2425581	58
2401206	66	2410010	69	2422012	72	2424652	149	2425583	58
2401208	66	2410014	69	2423050	64	2424654	149	2425585	58
2401210	66	2410502	69	2423102	146	2424670	149	2425590	58
2401500	80	2410504	69	2423104	146	2424672	149	2425592	58
2401502	80	2410506	69	2423106	146	2424674	149	2425594	58
2401506	80	2410508	69	2423302	146	2424802	147	2425601	58
2402006	79	2411002	65	2423304	146	2424804	147	2425603	58
2402008	79	2411004	65	2423306	146	2424806	147	2425605	58
2402102	76	2411006	65	2423504	146	2424808	147	2426002	238

NUMERICAL INDEX

2426003	238	2433502	258	2533000	16	2607004	116	2702600	227
2426006	259	2434012	71	2533001	16	2607500	119	2702602	227
2426008	259	2434014	71	2533002	16	2608002	119	2702604	227
2426010	238	2434014	71	2533004	16	2609002	119	2702606	227
2426050	34	2434018	71	2533006	16	2609502	119	2702608	227
2426052	34	2436002	76	2533008	16	2609602	119	2702610	227
2426102	35	2436004	76	2533012	16	2609702	119	2702614	227
2427402	74	2439002	70	2533014	16	2630002	18	2703002	227
2430002	103	2439004	70	2533015	16	2630004	18	2703004	227
2430500	69	2439006	70	2533016	16	2630006	18	2704002	227
2431002	71	2439008	70	2533018	16	2630007	18	2704004	227
2431004	71	2439010	70	2533020	16	2630008	18	2705002	228
2431006	71	2439012	70	2533022	16	2630010	18	2706002	227
2431008	71	2439014	70	2533500	16	2630012	18	2706004	227
2431010	71	2439016	70	2533502	16	2630014	18	2707002	228
2431012	71	2439018	70	2533506	16	2641002	18	2707006	228
2431014	71	2440001	77	2534000	16	2641004	18	2707008	228
2431016	71	2440002	77	2534202	82	2641006	18	2707010	228
2431018	71	2440003	77	2534204	82	2641008	18	2708004	228
2431020	71	2440004	77	2534206	82	2641010	18	2708006	228
2431500	71	2440006	77	2534208	82	2641012	18	2708502	228
2431502	71	24400087	77	2535000	16	2641014	18	2708504	228
2431504	71	2440010	77	2535004	136	2641016	18	2708506	228
2431506	71	2440012	77	2535006	136	2641018	18	2708508	228
2431508	71	2440014	77	2536000	16	2641020	18	2708602	228
2431510	71	2440015	77	2540002	17	2641022	18	2708802	228
2431512	71	2440016	77	2540004	17	2641024	18	2708804	228
2431514	71	2440016	77	2540006	17	2701000	227	2708806	228
2431516	71	2440018	77	2540008	17	2701002	227	2708808	228
2432002	69	2440019	77	2540010	17	2701004	227	2709002	228
2432500	79	2440020	77	2560002	14	2701006	227	2710002	189
2432502	79	2440022	77	2560004	14	2701008	227	2710004	189
2432600	82	2440030	78	2560006	14	2701010	227	2710006	189
2432602	82	2440050	78	2560008	14	2701012	227	2710008	189
2432610	82	2440102	78	2560010	14	2701014	227	2710010	189
2432612	82	2440104	78	2560012	14	2701016	227	2710012	189
2432620	82	2440110	78	2560014	14	2701018	227	2710502	189
2432622	82	2441010	258	2560016	14	2702000	227	2710504	189
2432624	82	2441012	258	2561002	14	2702002	227	2711007	92
2432630	82	2442002	258	2561004	14	2702004	227	2711008	92
2432710	82	2442010	258	2561006	14	2702006	227	2712002	92
2432750	82	2443050	258	2561008	14	2702008	227	2712004	92
2432760	82	2444002	236	2561010	14	2702010	227	2712006	48
2432802	82	2444004	236	2561012	14	2702012	227	2713002	129
2432806	82	2460002	259	2561014	14	2702014	227	2713004	129
2433002	235	2460004	259	2561016	14	2702016	227	2715002	48
2433102	258	2511008	60	2566002	145	2702018	227	2715004	48
2433104	258	2511010	60	2566004	145	2702500	227	2715802	48
2433202	258	2511012	60	2601002	117	2702502	227	2715804	48
2433204	258	2511014	60	2602002	117	2702504	227	2716000	163
2433302	258	2511016	60	2603002	117	2702506	227	2716001	163
2433304	258	2511018	60	2604002	118	2702508	227	2716002	163
2433402	258	2527002	86	2605002	116	2702510	227	2717002	181
2433404	258	2527004	86	2606002	116	2702514	227	2717004	181

NUMERICAL INDEX

2717006	181	2739002	23	2762001	35	2801510	1, 9	2814410	9
2717007	181	2739004	23	2763002	35	2801512	1, 9	2814412	9
2717010	181	2739006	23	2801002	1	2801514	1, 9	2814602	3
2717011	181	2739008	23	2801004	1	2803000	6	2814604	3
2717012	189	2739010	23	2801006	1	2803002	6	2814606	3
2717013	181	2739012	23	2801008	1	2803004	6	2814608	3
2717014	181	2739014	23	2801010	1	2803006	6	2814610	3
2717020	181	2739100	23	2801012	1	2803007	6	2815802	7
2718001	172	2739102	23	2801014	1	2803008	6	2815804	7
2718002	172	2739104	23	2801016	1	2803010	6	2815806	7
2718004	174	2739106	23	2801018	1	2804002	2	2815808	7
2718010	174	2739108	23	2801020	1	2804004	2	2815810	7
2718010	174	2739110	23	2801022	1	2804006	2	2816002	7
2718012	174	2739112	23	2801024	1	2804008	2	2816004	7
2718014	174	2739114	23	2801026	1	2804010	2	2816006	7
2719002	132	2739202	23	2801028	1	2804012	2	2816008	7
2719004	132	2739204	23	2801030	1	2804202	2	2816010	7
2721002	175	2739206	23	2801302	1	2804204	2	2816602	8
2722002	205	2739210	23	2801304	1	2804206	2	2816604	8
2722004	205	2739212	23	2801306	1	2804208	2	2816606	8
2724002	117	2739214	23	2801308	1	2804210	2	2816608	8
2725004	15	2739402	23	2801310	1	2804212	2	2816610	8
2725006	15	2739404	23	2801312	1	2804301	2	2817002	4
2725008	15	2739406	23	2801314	1	2804302	2	2817004	4
2735102	228	2739410	23	2801316	1	2804304	2	2817006	4
2737002	23	2739412	23	2801318	1	2804306	2	2817008	4
2737004	23	2739414	23	2801320	1	2804308	2	2817010	4
2737006	23	2741002	204	2801322	1	2804310	2	2817012	4
2737008	23	2744002	22	2801324	1	2804404	2	2817014	4
2737010	23	2744004	22	2801326	1	2804406	2	2817016	4
2737012	23	2744006	22	2801328	1	2804410	2	2817020	4
2737014	23	2744008	22	2801330	1	2804412	2	2817022	4
2737016	23	2744052	22	2801462	11	2806004	3	2817024	4
2737102	23	2744054	22	2801464	11	2806006	3	2817025	4
2737104	23	2744056	22	2801466	11	2806008	3	2817026	4
2737106	23	2744058	22	2801467	11	2806010	3	2817028	4
2737108	23	2745002	22	2801468	11	2806012	3	2817030	4
2737110	23	2745004	22	2801470	11	2806502	3	2817032	4
2737112	23	2745006	22	2801472	11	2806504	3	2817033	4
2737114	23	2745008	22	2801474	11	2806506	3	2817034	4
2737116	23	2746002	22	2801476	11	2806508	3	2817036	4
2737504	23	2746006	22	2801478	11	2806510	3	2817037	4
2737506	23	2746008	22	2801489	1, 9	2807001	10	2817038	4
2737508	23	2750002	50	2801490	1, 9	2807002	10	2817039	4
2737512	23	2750004	50	2801492	1, 9	2807004	10	2817040	4
2737514	23	2751002	50	2801494	1, 9	2807005	10	2817042	4
2737516	23	2751004	50	2801496	1, 9	2807006	10	2817043	4
2737704	23	2755002	50	2801498	1, 9	2807012	10	2817044	4
2737706	23	2755004	50	2801500	1, 9	2807048	10	2817046	4
2737708	23	2756002	50	2801502	1, 9	2814018	4	2817050	4
2737712	23	2756004	50	2801503	1, 9	2814402	9	2817060	4
2737714	23	2761002	35	2801504	1, 9	2814404	9	2817062	4
2737716	23	2761004	35	2801506	1, 9	2814406	9	2817112	10
2739000	23	2761006	35	2801508	1, 9	2814408	9	2817114	10

NUMERICAL INDEX

2817116	10	2818312	11	2840102	12	2880041	32	2885007	27
2817118	10	2818314	11	2840202	12	2880042	32	2885008	27
2817120	10	2820002	7	2840302	12	2880046	32	2885010	27
2817150	10	2820004	7	2840402	12	2880051	32	2885020	27
2817150	21	2820006	7	2861002	38	2880052	32	2885025	27
2817152	10	2820008	7	2861004	38	2880056	32	2885050	27
2817152	21	2820010	7	2862002	38	2880062	32	2885052	27
2817154	10	2822000	5	2862004	38	2881000	26	2885054	27
2817154	21	2822002	5	2863004	38	2881002	26	2885055	27
2817276	11	2822004	5	2864002	38	2881004	26	2885056	27
2817278	11	2822006	5	2864004	38	2881006	26	2885058	27
2817280	11	2822008	5	2864006	38	2881007	26	2885070	27
2817282	11	2822010	5	2864008	38	2881008	26	2886002	25
2817284	11	2822012	5	2864020	38	2881010	26	2886004	25
2817286	11	2822102	5	2864022	38	2881020	26	2886006	25
2817288	11	2822104	5	2864040	38	2881025	26	2886008	25
2817302	11	2822106	5	2864042	38	2882000	26	2886010	25
2817303	11	2822202	5	2866002	38	2882002	26	2886011	25
2817304	11	2822204	5	2866006	38	2882004	26	2886012	25
2817502	11	2822206	5	2866008	38	2882006	26	2886013	25
2817504	11	2822208	5	2867002	35	2882007	26	2886014	25
2817506	11	2822210	5	2867050	35	2882008	26	2886016	25
2817508	11	2822212	5	2867062	35	2882010	26	2886018	25
2817510	11	2822500	5	2870002	67	2882020	26	2886020	25
2817512	11	2822502	5	2870004	67	2882025	26	2886025	25
2817514	11	2822504	5	2870006	67	2883000	26	2886030	25
2817516	11	2822506	5	2870008	67	2883002	26	2886036	25
2817518	11	2822508	5	2870010	67	2883004	26	2886040	25
2817520	11	2822510	5	2870012	67	2883006	26	2886060	25
2817522	11	2822512	5	2871002	67	2883007	26	2886070	25
2817524	11	2822702	5	2871004	67	2883008	26	2886080	25
2817526	11	2822704	5	2872002	68	2883010	26	2887002	30
2817528	11	2822706	5	2872004	68	2883020	26	2887004	30
2817530	11	2822708	5	2872502	68	2883025	26	2887020	30
2817602	11	2822710	5	2872602	68	2883050	29	2887030	30
2817604	11	2822712	5	2872604	68	2883052	29	2887040	30
2817606	11	2827002	10	2872606	68	2883053	29	2887042	30
2817608	11	2827004	10	2872608	68	2883054	29	2887050	30
2817610	11	2827006	10	2880002	32	2883056	29	2887060	30
2817612	11	2827008	10	2880004	32	2883061	29	2887070	30
2817614	11	2827010	10	2880009	32	2883062	29	2888006	27
2817616	11	2827012	10	2880011	32	2883063	29	2888007	27
2817618	11	2827014	10	2880012	32	2883064	29	2888008	27
2817620	11	2830102	50	2880016	32	2883070	29	2888010	27
2817622	11	2830104	50	2880020	32	2883080	29	2888014	27
2817624	11	2833002	6	2880021	32	2883082	29	2888016	27
2817626	11	2833006	6	2880022	32	2883083	29	2888020	27
2817628	11	2833008	6	2880025	32	2883084	29	2888022	27
2817630	11	2834002	6	2880026	32	2884002	28	2888025	27
2817702	8	2834005	6	2880029	32	2884004	28	2890002	28
2817704	8	2834006	6	2880030	32	2885000	27	2890004	28
2817706	8	2834007	6	2880031	32	2885002	27	2890008	28
2817708	8	2834008	6	2880032	32	2885004	27	2890040	28
2817710	8	2840002	12	2880036	32	2885006	27	2890042	28

NUMERICAL INDEX

2891002	28	2935010	36	4021016	83	4220017	93	4304704	211
2891004	28	2935102	36	4021018	83	4220024	93	4305002	104
2891005	28	2935104	36	4021020	83	4220025	94	4305004	104
2891006	28	4016002	83	4021022	83	4220026	93	4305204	104
2891008	28	4016004	83	4021990	83	4220032	93	4305502	105
2891010	28	4016006	83	4022000	83	4220036	93	4305504	105
2891012	28	4016008	83	4022002	115	4220502	94	4306002	106
2891013	28	4016010	83	4022002	83	4220504	94	4306602	105
2891014	28	4016014	83	4022004	115	4220506	94	4307002	104
2891021	28	4016016	83	4022004	83	4220602	94	4307120	104
2891022	28	4017002	84	4023008	85	4220604	94	4307702	105
2891030	28	4017004	84	4030002	86	4220702	94	4307704	105
2891035	28	4017006	84	4030004	86	4220704	94	4309000	104
2891049	28	4017008	84	4030006	86	4220802	94	4309400	104
2891050	28	4017010	84	4031002	86	4220804	94	4309500	104
2892000	30	4018010	84	4031004	86	4221002	94	4309502	105
2892002	30	4018012	84	4031006	86	4221008	94	4309504	105
2892004	30	4018016	84	4031008	86	4221010	94	4310002	105
2892006	30	4018018	84	4031010	86	4221012	94	4310004	105
2892007	30	4018020	84	4031012	86	4222002	93	4311002	105
2892008	30	4018022	84	4031014	86	4222004	93	4311004	105
2892010	30	4018024	84	4031016	86	4222020	93	4312002	106
2893090	29	4019004	84	4031018	86	4225002	85	4313002	106
2893092	29	4019006	84	4031022	86	4225004	85	4313003	106
2893102	30	4019008	84	4031024	86	4225010	84	4313005	106
2893106	30	4019010	84	4031028	86	4225012	84	4318002	106
2893108	30	4019018	84	4031032	86	4225014	84	4320002	120
2893110	30	4019020	84	4103050	53	4225016	84	4320004	120
2894002	29	4019022	84	4103052	53	4225030	94	4320010	120
2894004	29	4019026	84	4103054	53	4225032	94	4320012	120
2894006	29	4019028	84	4104002	86	4225050	94	4320014	120
2894502	29	4019030	84	4104004	86	4226004	63	4320016	120
2894504	29	4019031	84	4105002	86	4226006	63	4320020	120
2894506	29	4019032	84	4105004	86	4226008	63	4320030	120
2894508	29	4019033	84	4106002	53	4226010	63	4323002	106
2896002	29	4019034	84	4106004	53	4226012	63	4324002	105
2896006	29	4019036	84	4106022	53	4227004	63	4324004	105
2930002	36	4019302	53	4107002	54	4227006	63	4326002	106
2930004	36	4019304	53	4107004	54	4227008	63	4402102	54
2930006	36	4019306	53	4107006	54	4227010	63	4402202	54
2930008	36	4019308	53	4107020	54	4227012	63	4404002	118
2930010	36	4020002	84	4107030	54	4301001	104	4406010	54
2931002	36	4020004	84	4109006	86	4301002	105	4406012	54
2931004	36	4020016	84	4109008	86	4301003	104	4407002	55
2931006	36	4020020	84	4220001	93	4301004	106	4407004	55
2931008	36	4020024	84	4220002	93	4301005	104	4407052	55
2931010	36	4020026	84	4220003	93	4301007	104	4407054	55
2933002	36	4020028	84	4220004	93	4301009	104	4407506	117
2933004	36	4020034	84	4220005	93	4301030	104	4413001	52
2933006	36	4021004	83	4220007	93	4301032	104	4413002	52
2935002	36	4021008	83	4220010	93	4301034	104	4413003	52
2935004	36	4021010	83	4220013	93	4302002	105	4413004	52
2935006	36	4021012	83	4220014	93	4303002	105	4413005	52
2935008	36	4021014	83	4220015	93	4304002	105	4413006	52

NUMERICAL INDEX

4415006	125	4663002	221	A000120	83	CB004	206	CJ500HLF	215
4415008	125	4664002	221	A000178	210	CB006	206	CL002	229
4417002	55	4666003	206	A000217	155	CB202	206	CL004	229
4418000	115	4666004	211	A000334	41	CB402CLF	206	CL006	229
4429002	15	4666008	206	A000337	24	CB402HLF	206	CL008	229
4429004	15	4666010	212	A000337	61	CB404CLF	206	CL010	229
4429005	15	4666020	214	A000352	188	CB404HLF	206	CR201CLF	207
4429072	15	4666022	205	A000860	37	CB410	206	CR201HLF	207
4429074	15	4666024	211	A000862	37	CB412	206	DD004	207
4429075	15	4666030	213	A000864	37	CB415	206	DD006	207
4429502	15	4666032	214	A000866	37	CB417	206	DD010	207
4429504	15	4666038	212	A000868	37	CB502	206	DD014	207
4430006	126	4667002	210	A000870	37	CBK01	217	DD014	207
4531000	14	4702002	99	A000874	37	CBK01-P	217	DD102	208
4531002	14	4706002	100	A000875	37	CD001	204	FM002	200
4531004	14	4706004	100	A000878	37	CD002	204	FM004	200
4531006	14	4706005	100	A000879	37	CD004	204	FM006	200
4531008	14	4708004	101	A000884	37	CD005	204	FM020	201
4531010	14	4708006	101	A000930	64	CD006	204	FM030	200
4531012	14	4708050	101	AS002	205	CD101	203	FM050	201
4532000	14	4708052	101	AS003	205	CD102	203	FM052	201
4532002	14	4709002	100	AS009	205	CD103	203	FM070	201
4532004	14	4709008	100	AS018	205	CD104	203	FM200	200
4532006	14	4709009	100	AS020	205	CD201	203	FM300	200
4532008	14	4710002	100	AS101	205	CD202	203	FM400	200
4532010	14	4710006	100	AS201	205	CD203	203	GB001	209
4532012	14	4710010	100	AS402CLF	205	CD204	203	GB002	209
4603003	117	4711002	100	AS402HLF	205	CD205	203	GB003	209
4607002	116	4711004	100	AS404LF	205	CD401	203	GB005	209
4609004	106	4816002	125	AS406CLF	205	CD402	203	GB006	209
4609006	106	4816004	125	AS406HLF	205	CD403	203	GB007	209
4610002	116	4816006	125	AS409CLF	205	CD404	203	GB008	209
46100022	207	4816008	125	AS409HLF	205	CD602	203	GB030	209
4610004	116	4816010	125	AS412	205	CD603	203	GB101	209
4610006	116	4816020	125	AS502	226	CD702	203	GB201	209
4610008	116	4819002	14	AS504	226	CD704	203	GB302	210
4610010	116	4819004	14	AS510	226	CD706	203	GB304	210
4610012	116	4819006	14	AS512	226	CD902	203	GB306	210
4610014	116	4819008	14	AS514	226	CD904	203	GB401	209
4610016	116	4819010	14	AS520	226	CD906	203	GB407CLF	209
4610018	116	4819012	14	AS522	226	CH002LF	207	GB407HLF	209
4610020	116	4819104	15	AS524	226	CH004LF	207	GB412	209
4610022	116	4819106	15	AS526	226	CJ001	127	GB501	224
4610024	116	4819108	15	AS528	226	CJ003	127	GB502	224
4610026	116	4819110	15	AS630	226	CJ101	127	GB503	224
4610028	116	4819112	15	AS634	226	CJ302	127	GB504	224
4610030	116	4819206	14	ASK01	217	CJ302	215	GB505	224
4610032	116	4819208	14	BDGT-10	42	CJ401CLF	127	GB506	224
4623002	159	4819210	14	BDGT-5	42	CJ401CLF	215	GBF1LF	219
4623002	53	4819212	14	BR101	211	CJ401HLF	127	GBK01	218
4623010	159	4819402	15	CB001	206	CJ401HLF	215	GBK02	218
4623010	53	4819404	15	CB002	206	CJ500CLF	127	GL402C	210
4623050	159	4819502	15	CB003	206	CJ500CLF	215	GL402H	210
4647004	207	4819504	15	CB004	206	CJ500HLF	127	GL404C	210

NUMERICAL INDEX

GL404H	210	PP007	212	SR138	196	SR760	198
GT-10	42	PP022	212	SR140	199	SR762	198
GT-5	42	PP202	212	SR142	199	SR770	198
HH001	216	PP402LF	212	SR144	196	SR772	198
KK001	210	PP410	212	SR148	196	SR812	196
KK002	210	PP412	212	SR150	196	SR814	196
KK003	210	PP414	212	SR152	196	SR902	193
KK402CLF	210	PP502	212	SR154	196	SR903	193
KK402HLF	210	PPK01	218	SR199	193	SR904	193
KK404CLF	210	RV100LF	95	SR202	194	SR906	193
KK404HLF	210	RV104LF	95	SR204	194	SR907	193
KK410C	210	RV500LF	95	SR206	194	SR908	193
KK410H	210	RV502LF	95	SR208	194	SR930	198
KK412	210	RV700LF	95	SR210	194	SR932	197
KKK01	218	RV702LF	95	SR212	194	SR938	197
MB102LF	95	RV900LF	118	SR214	194	SR940	198
MB104LF	95	SA001	214	SR222	194	SR942	198
MB202LF	95	SA006	214	SR224	194	SR944	197
MB206LF	95	SA101	214	SR226	194	SR950	194
MB208LF	95	SA201	214	SR228	194	SR952	194
MM002	211	SA401H	214	SR302	196	SR954	194
MM004	211	SA412	214	SR304	196	SR956	194
MM030	211	SAK01	219	SR306	196	ST003	214
ODP20	222	SDP04	167	SR308	196	ST004	214
ODP22	222	SDP12	167	SR310	196	ST006	214
ODP28	222	SDP16	167	SR312	196	ST102	214
ODP30	222	SDP24	167	SR402	194	ST202	215
ODP34	223	SDP28	167	SR404	194	ST410	214
ODP36	222	SM001	215	SR410	194	ST412	214
ODP51	222	SM401	215	SR412	194	STK01	219
ODP52	223	SPD08	167	SR414	194	SV402CLF	213
ODP55	223	SR002	195	SR416	194	SV402HLF	213
ODP56	223	SR004	193	SR418	195	SV410	213
ODP57	223	SR006	193	SR420	195	SV411	213
ODP58	223	SR008	193	SR422	195	SY001	213
OGP01	224	SR010	193	SR430	194	SY002	213
OGP06	225	SR101	193	SR432	194	SY102	213
OGP08	225	SR102	193	SR502	195	SY103	213
OGP10	225	SR104	193	SR504	195	SY201	213
OGP14	225	SR106	195	SR506	195		
OGP16	225	SR108	195	SR508	195		
OGP18	225	SR110	194	SR510	195		
OGP20	224	SR112	199	SR512	195		
OGP30	225	SR114	199	SR514	195		
OGP31	225	SR116	195	SR602	195		
OGP32	225	SR118	195	SR604	195		
OGP34	225	SR120	193	SR700	199		
OGP36	225	SR121	193	SR730	198		
OGP40	224	SR122	195	SR732	198		
OGP42	224	SR128	196	SR734	198		
OGP45	225	SR129	196	SR740	197		
PP004	212	SR130	196	SR742	197		
PP005	212	SR131	196	SR750	197		
PP006	212	SR136	195	SR752	197		